

## GNS-8011Ax-Bx (SINGLE DIGIT LED DISPLAY)

### NFD-8011 Series

### NFD-8011Ax

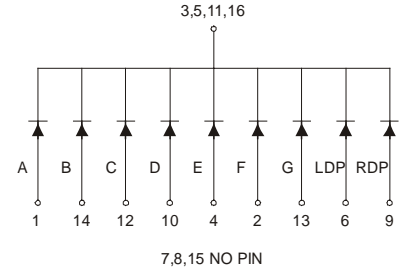
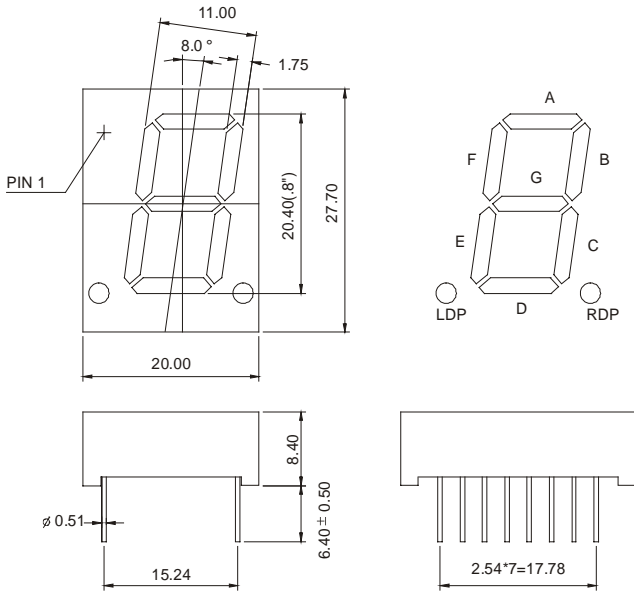

### NFD-8011Bx

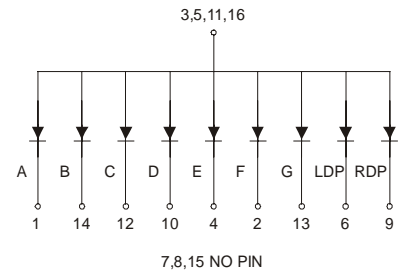

### Features:

\*0.8 INCH HIGH CHARACTER.

\*EXCELLENT CHARACTER APPEARANCE.

\*COMMON CATHODE OR COMMON ANODE.

\*I.C. COMPATIBLE.

\*LOW POWER CONSUMPTION.

Part Number	EMITTED COLOR		Common Cathode or Common Anode	Peak Wavelength (nm)	Vf (v) Typ	If (mA)	Intensity Per Segment (mcd)	
							Min.	Typ.
GNS-8011AE	GaAsP/GaP	Hi.effi Red	Common Cathode	635	2.0	20	9	12
GNS-8011AG	GaP	Green		565	2.1	20	8	11
GNS-8011AY	GaAsP/GaP	Yellow		585	2.0	20	9	12
GNS-8011AS	GaAlAs	Super Red		660	1.8	20	10	13
GNS-8011AD	GaAlAs	Ultra Red		660	1.8	20	25	30
GNS-8011AUE	AlGaInP	Ultra Red		625	2.0	20	30	35
GNS-8011AUY	AlGaInP	Ultra Yellow		590	2.0	20	30	35
GNS-8011BE	GaAsP/GaP	Hi.effi Red	Common Anode	635	2.0	20	9	12
GNS-8011BG	Gap	Green		565	2.1	20	8	11
GNS-8011BY	GaAsP/GaP	Yellow		585	2.0	20	9	12
GNS-8011BS	GaAlAs	Super Red		660	1.8	20	10	13
GNS-8011BD	GaAlAs	Super Red		660	1.8	20	25	30
GNS-8011BUE	AlGaInP	Ultra Red		625	2.0	20	30	35
GNS-8011BUY	AlGaInP	Ultra Yellow		590	2.0	20	30	35