

承認書

SPECIFICATION FOR APPROVAL

CUSTOMER : 烏克蘭
MODEL NAME : POWER TRANSFORMER
CUSTOMER P/N : RC-F29H-C20
L.T.E. PART NO. : _____
DATE : 2006.08.16.

核准 APPROVED	校對 CHECKED	承辦 ISSUED
劉易鑫	劉月鳳	邱若婷

客戶承認 FOR CUSTOMER APPROVAL	
簽名 SIGNATURE	日期 DATE





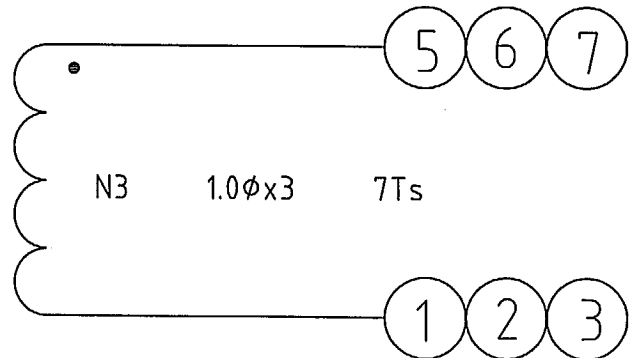
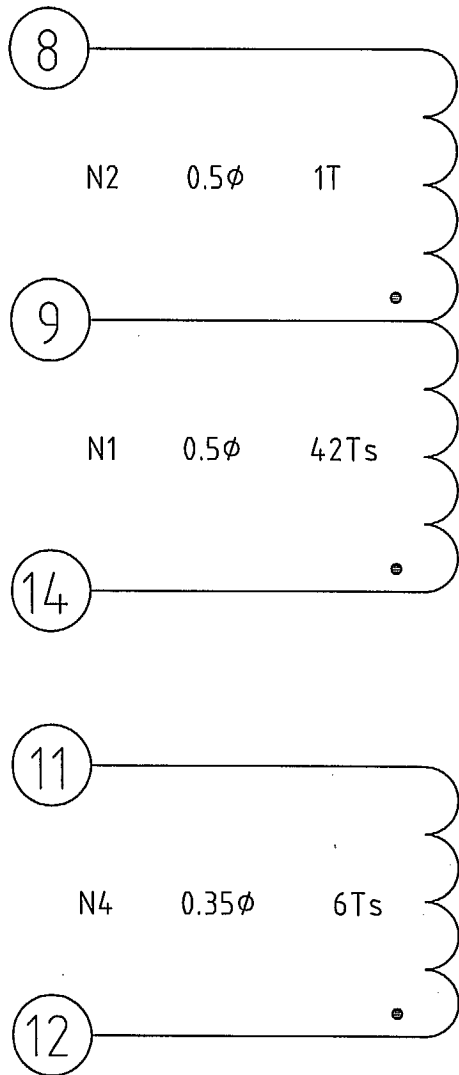

力英電子股份有限公司
Li Tone Electronics (L.T.E.) Co., Ltd
臺北縣三峽鎮介壽路1段311巷29號
No.29, Lane 311, Sec 1, JieSou Rd.
Sanhsia, Taipei, Taiwan 237
<http://www.LTE.com.tw>

TEL:+886-2-2673-2512
FAX:+886-2-2671-0294
+886-2-2671-9331
+886-2-8671-3701

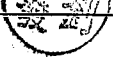
1. SCHEMATICS.



CUSTOMER: 烏克蘭		APPROVED BY: 	
PART NO. RC-F29H-C20 E04-10293512-00		ISSUE: B	CHECKED BY: 
DATE: 2006.08.16.		DRAWN BY: 	
 		<p>力英電子股份有限公司 LI TONE ELECTRONICS CO., LTD. 台北縣三峽鎮介壽路1段311巷29號 NO. 29, LANE 311, JIE SOU RD., SEC 1. SANHSIA TOWN TAIPEI HSIEN, TAIWAN R. O. C.</p>	
		<p>TEL: (02)2673-2512~6</p> <p>FAX: 886-2-26710294 886-2-26736329</p>	

2. WINDING SEQUENCE.

*PIN 1. 朝內.

*N1. 繞時須層間絕緣，N2. 繞線需接在 N1. 後繞.

*全部須加 TUBE.

*注意 N3. 的配線方式(如外觀圖所示)

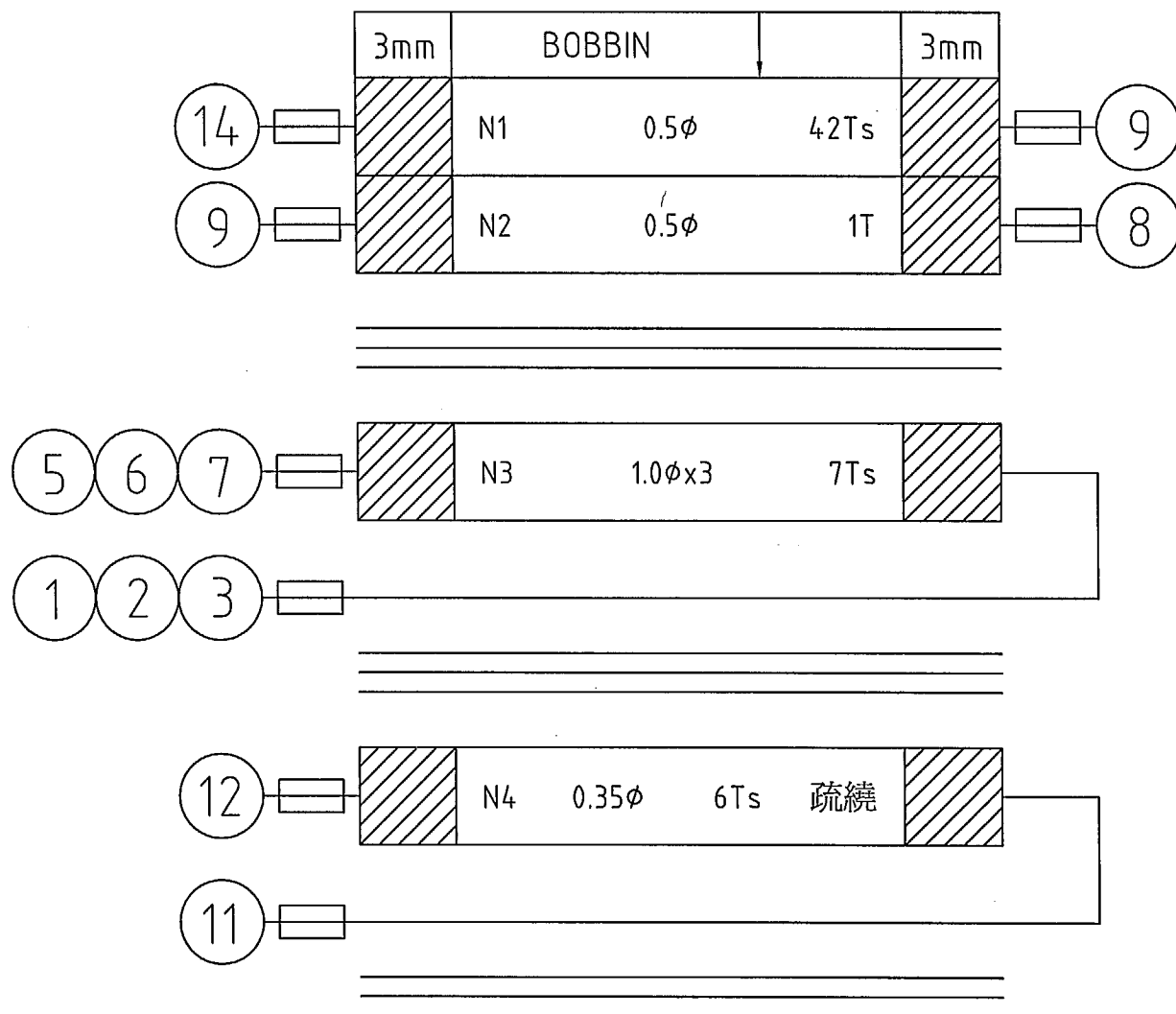

CUSTOMER: 烏克蘭

APPROVED BY: 

PART NO. RC-F29H-C20
E04-10293512-00

ISSUE: B

CHECKED BY: 

DATE: 2006.08.16.

DRAWN BY: 

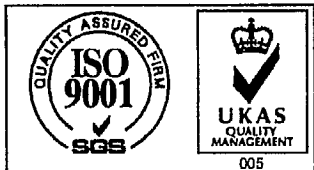

力英電子股份有限公司
LI TONE ELECTRONICS CO., LTD.
台北縣三峽鎮介壽路1段311巷29號
NO. 29, LANE 311, JIE SOU RD., SEC 1. SANHSIA
TOWN TAIPEI HSIEN, TAIWAN R. O. C.

TEL:
(02)2673-2512~6

FAX:
886-2-26710294
886-2-26736329

3.MATERIAL LIST.

NO/ITEM	MATERIAL	MAKER
1.CORE	ETD-29 FERRITE CORE. PC40.	TDK.
2.BOBBIN	ETD-29 H. TYPE W / 14PINS PHENOLIC / T375J. YW-166.	CHANG CHUN PLASTICS CO.,LTD. UL NO.E59481(S). YIH HWA BOBBIN ENTERPRISES CO.,LTD.
3.WIRE	2UEW / 130°C.	PACIFIC ELECTRIC WIRE & CABLE CO. UL NO.E84081(S).
4.TAPE	POLYESTER TAPE. #1350F-1. / #44.	3M COMPANY UL NO.E17385(N).
5.VARNISH	V-1630FS.	P D GEORGE / VIKING . UL NO.E60614(M)
6.CLIP	ETD-29 HIGH CARBON STEEL.	HEN SHEN INDUSTRIAL CO.,LTD.
7.TUBING	PTFE / TFL /150V.	GREAT HOLDING IND CO.,LTD. UL NO.E156256(S).
8.SOLDER	PURE TIN / Pb<100ppm 2HAO,2LF30	WELLEY SOLDER CO.,LTD.



*ROHS COMPLIANT(無鉛製程)

4.ELECTRICAL SPECIFICATION.

4-1.INDUCTANCE.(P14-P9) 353uH±10%. @1 KHZ 0.25V BY HP-4284A.

4-2.D.C.RESISTANCE.(P14-P9) 0.22Ω MAX. BY GOM-801G.



4-3.HI-POT.: PRI - SEC : 3KVC FOR 1MINUTE @5mA. 60HZ.

CUSTOMER: 烏克蘭		APPROVED BY:
PART NO. RC-F29H-C20 E04-10293512-00	ISSUE: B	CHECKED BY:
DATE: 2006.08.16.		DRAWN BY:
 		力英電子股份有限公司 LI TONE ELECTRONICS CO., LTD. 台北縣三峽鎮介壽路1段311巷29號 NO. 29, LANE 311, JIE SOU RD., SEC 1. SANHSIA TOWN TAIPEI HSIEN, TAIWAN R. O. C.
		TEL: (02)2673-2512~6 FAX: 886-2-26710294 886-2-26736329

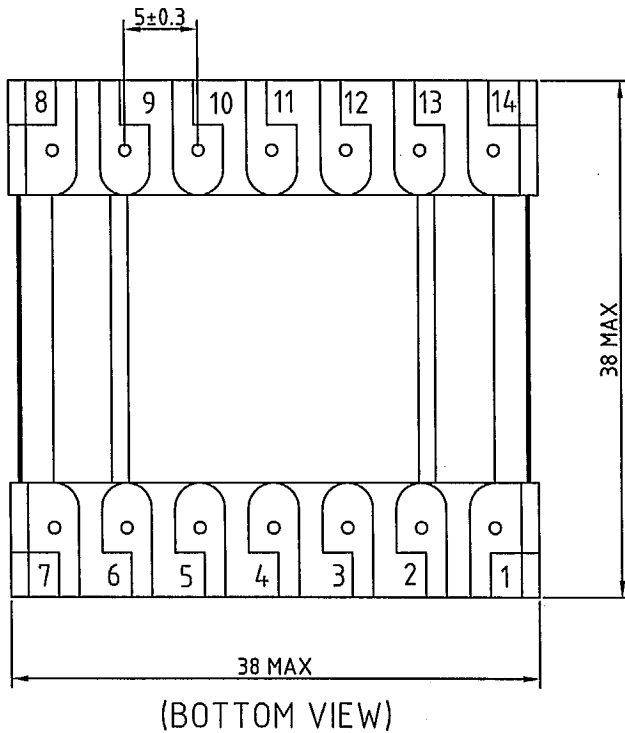
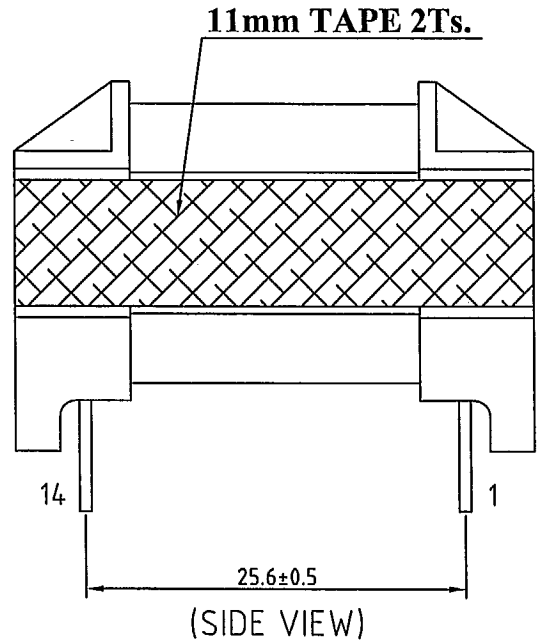
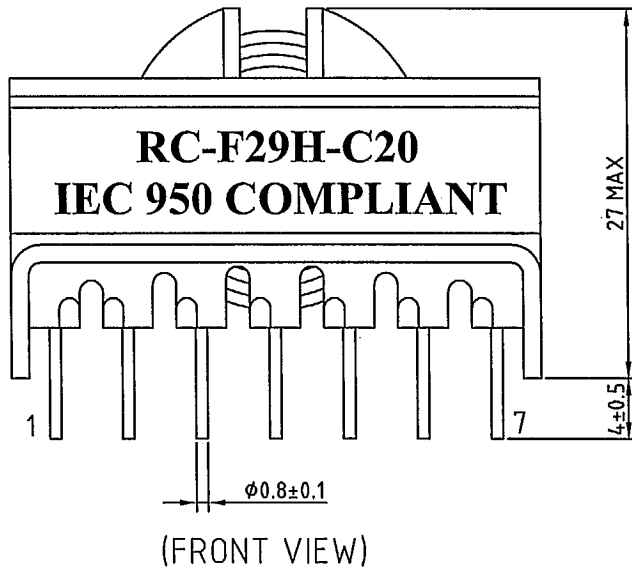
5.CONFIGURATION & DIMENSION.(UNIT:mm)





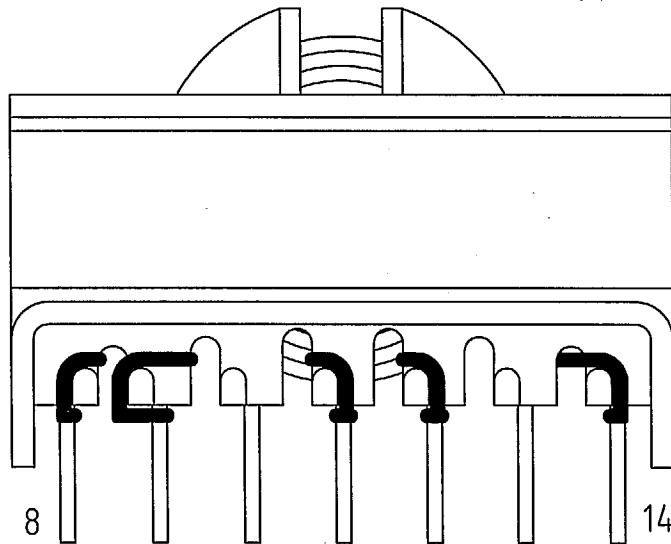
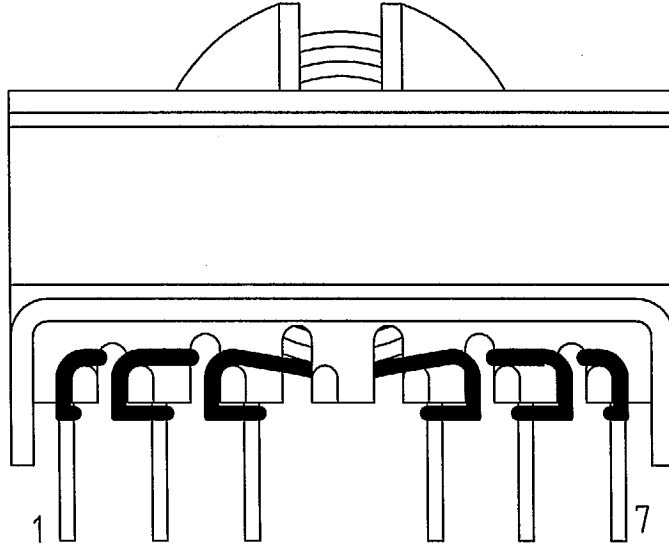

- *鐵夾外圍需包 2T TAPE.
- *注意 N3. 的配線方式
- *PIN 1. 點白點.
- *PIN 4. CUT OFF.

CUSTOMER: 烏克蘭		APPROVED BY:
PART NO. RC-F29H-C20 E04-10293512-00	ISSUE: B	CHECKED BY:
DATE: 2006.08.16.		DRAWN BY:
 		TEL: (02)2673-2512~6
力英電子股份有限公司 LI TONE ELECTRONICS CO., LTD. 台北縣三峽鎮介壽路1段311巷29號 NO. 29, LANE 311, JIE SOU RD., SEC 1. SANHSIA TOWN TAIPEI HSIEN, TAIWAN R. O. C.		FAX: 886-2-26710294 886-2-26736329

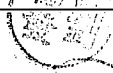
配線方式



CUSTOMER: 烏克蘭	APPROVED BY: 	
PART NO. RC-F29H-C20 E04-10293512-00	ISSUE: B	CHECKED BY: 
 	DATE: 2006.08.16.	DRAWN BY: 
	<p style="text-align: center;">力英電子股份有限公司 LI TONE ELECTRONICS CO., LTD. 台北縣三峽鎮介壽路1段311巷29號 NO. 29, LANE 311, JIE SOU RD., SEC 1. SANHSIA TOWN TAIPEI HSIEN, TAIWAN R. O. C.</p>	