

SCHOTTKY RECTIFIER

3.3 Amp

Major Ratings and Characteristics

Characteristics	31DQ..	Units
$I_{F(AV)}$ Rectangular waveform	3.3	A
V_{RRM}	50/60	V
I_{FSM} @ $t_p = 5 \mu s$ sine	340	A
V_F @ 3 Apk, $T_J = 25^\circ C$	0.62	V
T_J	-40 to 150	$^\circ C$

Description/Features

The 31DQ.. axial leaded Schottky rectifier has been optimized for very low forward voltage drop, with moderate leakage. Typical applications are in switching power supplies, converters, free-wheeling diodes, and reverse battery protection.

- Low profile, axial leaded outline
- High purity, high temperature epoxy encapsulation for enhanced mechanical strength and moisture resistance
- Very low forward voltage drop
- High frequency operation
- Guard ring for enhanced ruggedness and long term reliability

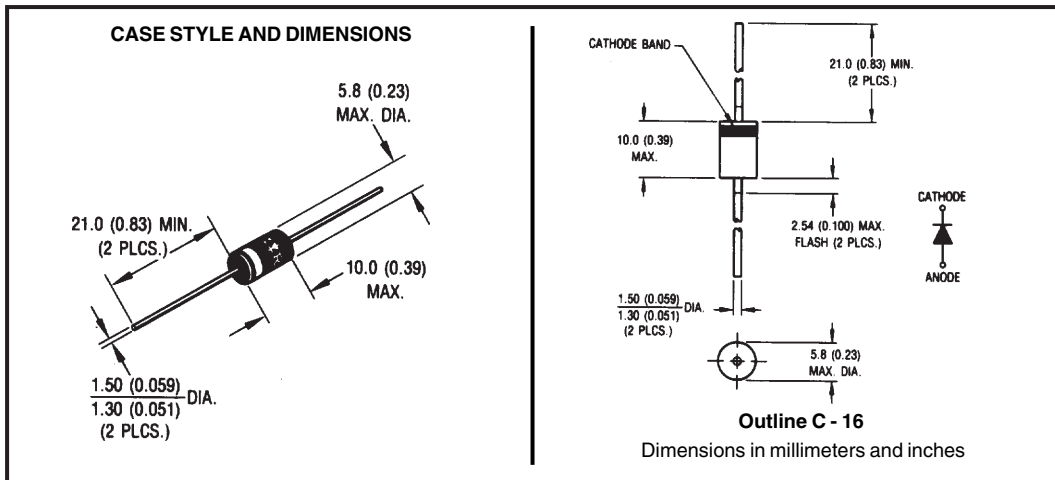

Voltage Ratings

Part number	31DQ05	31DQ06
V_R Max. DC Reverse Voltage (V)	50	60
V_{RWM} Max. Working Peak Reverse Voltage (V)		

Absolute Maximum Ratings

Parameters	31DQ..	Units	Conditions
$I_{F(AV)}$ Max. Average Forward Current * See Fig. 4	3.3	A	50% duty cycle @ $T_A = 40^\circ\text{C}$, rectangular wave form With cooling fins
I_{FSM} Max. Peak One Cycle Non-Repetitive Surge Current * See Fig. 6	340	A	Following any rated load condition and with rated V_{RWM} applied
	55		

Electrical Specifications

Parameters	31DQ..	Units	Conditions
V_{FM} Max. Forward Voltage Drop * See Fig. 1 (1)	0.62	V	@ 3A $T_J = 25^\circ\text{C}$
	0.78	V	@ 6A
	0.54	V	@ 3A $T_J = 125^\circ\text{C}$
	0.65	V	@ 6A
I_{RM} Max. Reverse Leakage Current * See Fig. 2 (1)	2	mA	$T_J = 25^\circ\text{C}$ $V_R = \text{rated } V_R$
	15	mA	$T_J = 125^\circ\text{C}$
C_T Typical Junction Capacitance	160	pF	$V_R = 5V_{DC}$, (test signal range 100Khz to 1Mhz) 25°C
L_S Typical Series Inductance	9.0	nH	Measured lead to lead 5mm from package body

(1) Pulse Width < 300 μs , Duty Cycle <2%

Thermal-Mechanical Specifications

Parameters	31DQ..	Units	Conditions
T_J Max. Junction Temperature Range	-40 to 150	$^\circ\text{C}$	
T_{stg} Max. Storage Temperature Range	-40 to 150	$^\circ\text{C}$	
R_{thJA} Max. Thermal Resistance Junction to Ambient	80	$^\circ\text{C/W}$	DC operation Without cooling fins
R_{thJA} Typical Thermal Resistance Junction to Ambient	34	$^\circ\text{C/W}$	With fin 20x20 (0.79x0.79) 1.0 (0.04) thick. Dimensions in millimeters (inches)
wt Approximate Weight	1.2 (0.042)	g (oz.)	
Case Style	C-16		

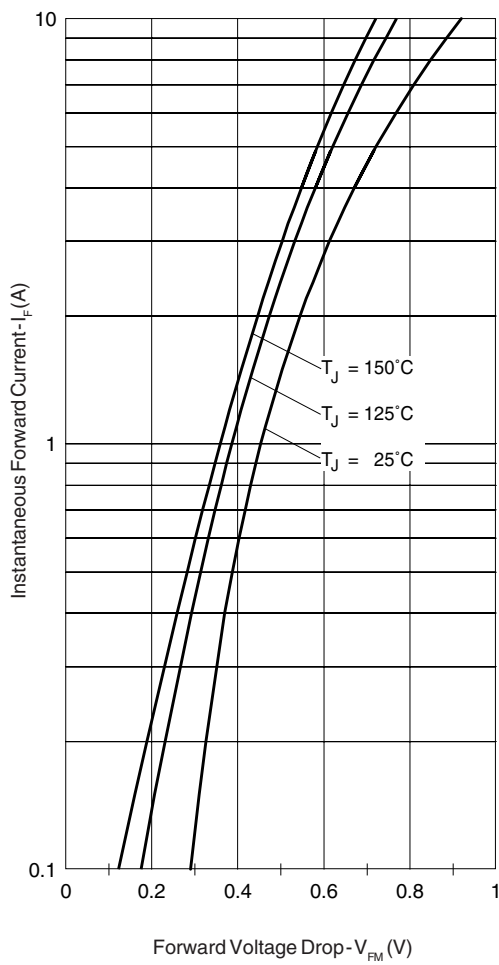

Fig. 1 - Max. Forward Voltage Drop Characteristics

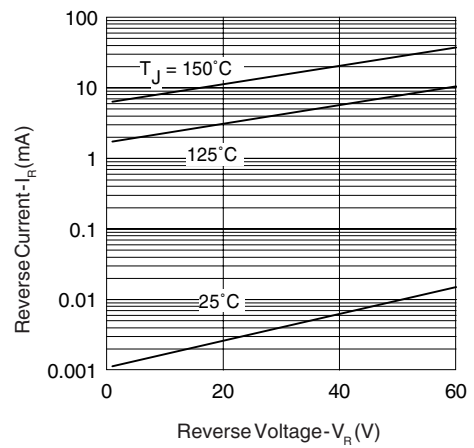

Fig. 2 - Typical Values Of Reverse Current Vs. Reverse Voltage

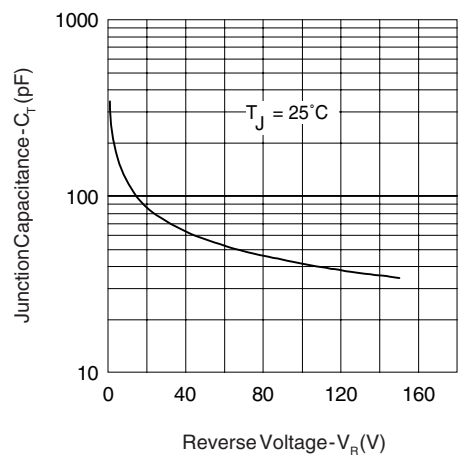

Fig. 3 - Typical Junction Capacitance Vs. Reverse Voltage

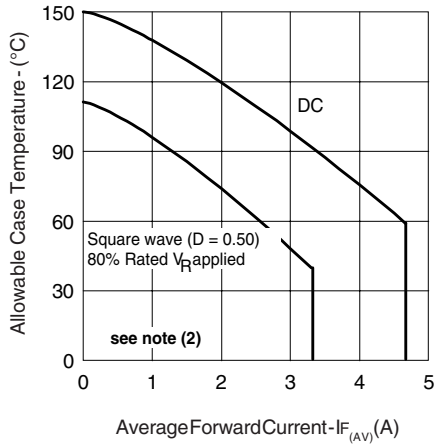

Fig. 4 - Max. Allowable Case Temperature Vs. Average Forward Current

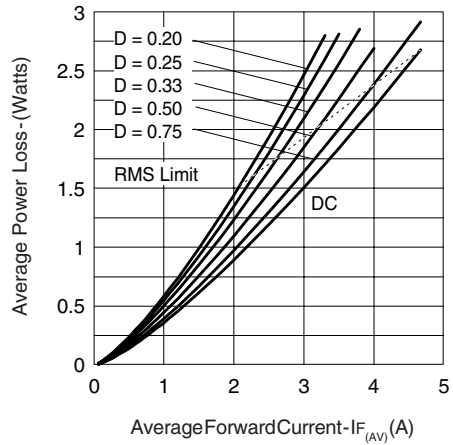

Fig. 5 - Forward Power Loss Characteristics

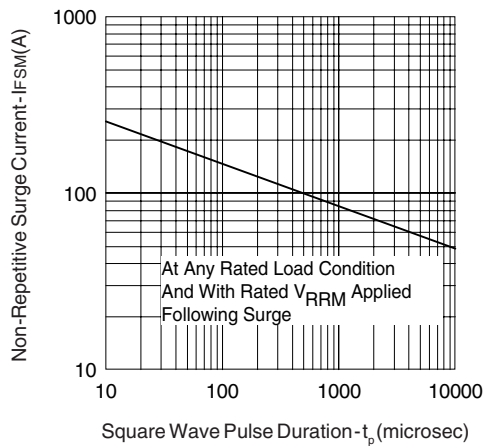

Fig. 6 - Max. Non-Repetitive Surge Current

(2) Formula used: $T_C = T_J - (Pd + Pd_{REV}) \times R_{thJC}$;
 $Pd = \text{Forward Power Loss} = I_{F(AV)} \times V_{FM} @ (I_{F(AV)} / D)$ (see Fig. 6);
 $Pd_{REV} = \text{Inverse Power Loss} = V_{R1} \times I_R (1 - D); I_R @ V_{R1} = 80\% \text{ rated } V_R$

International
IOR Rectifier

WORLDHEADQUARTERS: 233 Kansas St., El Segundo, California 90245 U.S.A Tel: (310) 322-3331 Fax: (310) 322-3332
EUROPEANHEADQUARTERS: Hurst Green, Oxted, Surrey RH8 9BB, U.K. Tel: ++ 44 1883 732020 Fax: ++ 44 1883 733408
IR CANADA: 7231 Victoria Park Ave., Suite #201, Markham, Ontario L3R 2Z8 Tel: (905) 475 1897. Fax: (905) 475 8801
IR GERMANY: Saalburgstrasse 157, 61350 Bad Homburg Tel: ++ 49 6172 96590 Fax: ++ 49 6172 965933
IR ITALY: Via Liguria 49, 10071 Borgaro, Torino Tel: ++ 39 11 4510111 Fax: ++ 39 11 4510220
IR FAR EAST: K&H Bldg., 2F, 30-4 Nishi-Ikebukuro 3-Chome, Toshima-Ku, Tokyo, Japan 171 Tel: 81 3 3983 0086 Fax: 81 3 3983 0642
IR SOUTHEAST ASIA: 315 Outram Road, # 10-02 Tan Boon Liat Building, SINGAPORE 0316. Tel: 65 221 8371. Fax: 65 221 8372.