

982 III Soldering Station ESD Safe & Temperature-Adjustable

OPERATION INSTRUCTION

Made in China

Statement: The company reserves the right to improve & upgrade products, product specifications and design are subject to change without notice.

● This product should not be thrown in the garbage. In accordance with the European directive 2012/19/EU, electronic equipment at the end of their life must be collected & returned to an authorized recycling facility. ● Este producto no debe desecharse en la basura. De acuerdo a la directiva europea 2012/19/EU, los equipos electrónicos al final de su vida se deberán recoger y trasladar a una planta de reciclaje autorizada. ● Dieses Produkt sollte nicht mit dem Hausmüll entsorgt werden. In Übereinstimmung mit der europäischen Richtlinie 2012/19/EU müssen elektronische Geräte am Ende ihrer Lebensdauer eingesammelt und einem autorisierten Recyclingbetrieb zugeführt werden.

Select the corresponding logo according to the nameplate.



I. Product Diagram

1. Heating Element Model
2. Actual Temperature
3. Soldering Iron Power Indicator(115/210)
4. Set Temperature
5. Soldering Iron
6. Solder Wire Holder
7. Temperature Decrease Button
8. Tip Cleaner
9. Residual Tray
10. Helping Hands
11. Temperature Increase Button
12. Locking Screw for Cable Guide
13. Soldering Iron Holder
14. Groove (For Heating Element Change)
15. Cable Guide
16. Power Switch
17. Receptacle (Soldering Iron)
18. Power Cord

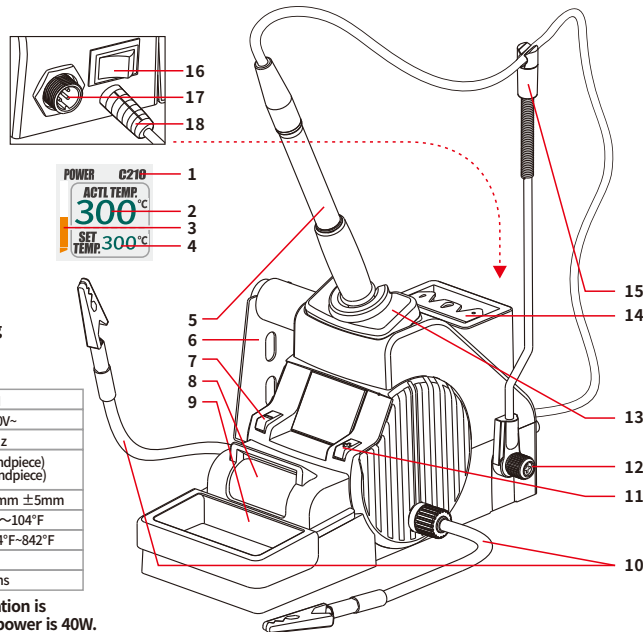

NOTE: The solder wire holder and helping hands are sold separately. Please contact our official store to purchase.

Model number	982 III
Rated voltage range	110V-240V~
Rated frequency	50-60Hz
Rated power	40w (210 Handpiece) 30w (115 Handpiece)
Main unit dimensions	L180*W68*H110mm ±5mm
Operating ambient temperature	0~40°C/32°F~104°F
Temperature range	90°C~450°C/194°F~842°F
Display	LCD
Tip to ground resistance	<2 Ohms

NOTE: its rated power is 60W. When the station is connected with a 210 handpiece, its rated power is 40W. When the station is connected with a 115 handpiece, its rated power is 30W.

IMPORTANT SAFETY GUIDELINES

Strictly follow the basic safety guidelines and precautions when using the product. The guidelines include:

CAUTION!!! WARNING!!!

Read instruction manual before using.

1. To provide continued protection against risk of electric shock, connect to properly grounded outlets only.
2. Do not immerse in water.
3. Hot Surface. Avoid Contact.
4. Shock Hazard. To provide continued protection against electric shock disconnect from the power supply when not in use.
5. Heat gun, soldering iron, desoldering iron must be placed on its stand when not in use.
6. HOUSEHOLD AND INDOOR USE ONLY.
7. To prevent electric shock, unplug before replace the fuse and other service.
8. Replace only with same type and rating of fuse.
9. This appliance is not intended for use by persons (including children) with reduced physical, sensory or mental capabilities, or lack of experience and knowledge, unless they have been given supervision or instruction concerning use of the appliance by a person responsible for their safety.
10. Children should be supervised to ensure that they do not play with the appliance.
11. The soldering iron and desoldering iron is only to be used with the power supply unit provided with the appliance.
12. If the SUPPLY CORD is damaged, it must be replaced by the manufacturer, its service agent or similarly qualified persons in order to avoid a hazard.
13. Any servicing should be performed by an authorized service representative AND that the product has no user serviceable parts.
14. To reduce the risk of fire or electric shock, do not expose this product to rain or moisture. Store indoors. Read instruction manual before using.
15. A fire may result if the appliance is not used with care, therefore
 - be careful when using the appliance in places where there are combustible materials;
 - do not apply to the same place for a long time;
 - do not use in presence of an explosive atmosphere;
 - be aware that heat may be conducted to combustible materials that are out of sight;
 - place the appliance on its stand after use and allow it to cool down before storage;
 - do not leave the appliance unattended when it is switched on.
16. Hidden areas such as behind walls, ceilings, floors, soffit boards and other panels may contain flammable materials that could be ignited by the heat gun when working in these locations. The ignition of these materials may not be readily apparent and could result in property damage and injury to persons. When working in these locations, keep the heat gun moving in a back-and-forth motion. Lingering or pausing in one spot could ignite the panel or the material behind it.
17. WARNING: Extreme care should be taken when stripping paint. The peelings, residue and vapors of paint may contain lead, which is poisonous. Any pre-1977 paint may contain lead and paint applied to homes prior to 1950 is likely to contain lead. Once deposited on surfaces, hand to mouth contact can result in the ingestion of lead. Exposure to even low levels of lead can cause irreversible brain and nervous system damage; young and unborn children are particularly vulnerable.
18. Before beginning any paint removal process you should determine whether the paint you are removing contains lead. This can be done by your local health department or by a professional who uses a paint analyzer to check the lead content of the paint to be removed.
19. LEAD-BASED PAINT SHOULD ONLY BE REMOVED BY A PROFESSIONAL AND SHOULD NOT BE REMOVED USING A HEAT GUN.
20. Persons removing paint should follow these guidelines:
 - 1) Move the work piece outdoors. If this is not possible, keep the work area well ventilated. Open the windows and put an exhaust fan in one of them. Be sure the fan is moving the air from inside to outside.
 - 2) Remove or cover any carpets, rugs, furniture, clothing, cooking utensils and air ducts.
 - 3) Place drop cloths in the work area to catch any paint chips or peelings. Wear protective clothing such as extra work shirts, overalls and hats.
 - 4) Work in one room at a time. Furnishings should be removed or placed in the center of the room and covered. Work areas should be sealed off from the rest of the dwelling by sealing doorways with drop cloths.
 - 5) Children, pregnant or potentially pregnant women and nursing mothers should not be present in the work area until the work is done and all clean up is complete.
 - 6) Wear a dust respirator mask or a dual filter (dust and fume) respirator mask which has been approved by the Occupational Safety and Health Administration (OSHA), the National Institute of Safety and Health (NIOSH), or the United States Bureau of Mines. These masks and replaceable filters are readily available at major hardware stores. Be sure the mask fits. Beards and facial hair may keep masks from sealing properly. Change filters often. DISPOSABLE PAPER MASKS ARE NOT ADEQUATE.
 - 7) Use caution when operating the heat gun. Keep the heat gun moving as excessive heat will generate fumes which can be inhaled by the operator.
 - 8) Keep food and drink out of the work area. Wash hands, arms and face and rinse mouth before eating or drinking. Do not smoke or chew gum or tobacco in the work area.
 - 9) Clean up all removed paint and dust by wet mopping the floors. Use a wet cloth to clean all walls, sills and any other surface where paint or dust is clinging. DO NOT SWEEP, DRY DUST OR VACUUM. Use a high phosphate detergent or trisodium phosphate (TSP) to wash and mop areas.
 - 10) At the end of each work session put the paint chips and debris in a double plastic bag, close it with tape or twist ties and dispose of properly.
 - 11) Remove protective clothing and work shoes in the work area to avoid carrying dust into the rest of the dwelling. Wash work clothes separately. Wipe shoes off with a wet rag that is then washed with the work clothes. Wash hair and body thoroughly with soap and water.
21. To ensure personal safety, please turn off the power switch after work is completed; When not in use for an extended period, please unplug the power cord!!!
22. Do not install nozzle when the hot air gun is turned on, the heat pipe and the nozzle must be cooling. Then installed the other nozzle.
23. The soldering iron should only be used for soldering. Do not hit the soldering iron against the work surface to remove flux residues (Can be cleaned by the cleaning device of the product), as doing so may seriously damage the soldering iron.
24. Soldering produces fumes, ensure there is adequate ventilation.
25. After used, remember that cooling the unit, the handle should be placed on the handle holder.
26. Longer detachable power-supply cords are available and may be used if care is exercised in their use.
27. If a long detachable power-supply cord is used: 1) The marked electrical rating of the detachable power-supply cord or extension cord should be at least as great as the electrical rating of the appliance; 2) The extension cord should be a grounding type 3-wire cord; 3) The longer cord should be arranged so that it will not drape over the countertop or tabletop where it can be tripped over, snagged, or pulled on unintentionally (especially by children).
28. A short power-supply cord (or short detachable power-supply cord) is provided to reduce the risks resulting from becoming entangled in or tripping over a longer cord.
29. If the bottom of the brass wool tip cleaner contains solid-state rosin, the below warning applies: This product contains rosin (colophony), and the substance may cause an allergic skin reaction. When using the tip cleaner (rosin-inside), DO NOT inhale the fume generated or consume the solid-state rosin, DO NOT allow your skin and eyes to get in direct contact with the rosin.

III. Operation Instructions

This unit is suitable for desoldering and soldering operations on various surface-mount components and through-hole components, such as SOP, DIP, SOIC, etc.

IV. Maintenance & Precautions

1. If a layer of oxidization forms on the surface of the soldering iron tip, a misconception can be created that the tip cannot heat up properly to melt the solder and do the tinning. However, the actual temperatures of both the heating element and the tip are high. In such an instance, please do not increase the temperature value further but use a metal wool ball to remove the oxidization following the steps below:
 - A. Set the temperature to 300°C (572°F).
 - B. Once the temperature stabilizes, gently rub the soldering iron tip inside the metal wool ball.
 - C. When the oxidization is partially removed, continue applying solder onto the soldering iron tip while rubbing it until the tip is completely coated with solder. If the tip is too severely oxidized beyond cleaning, replace it with a new one.
2. DO NOT use metal files to remove the oxidization on the soldering iron tip. If the soldering iron tip deforms or rusts, replace the soldering iron tip with a new tip.
3. DO NOT apply excessive force on the soldering iron tip when soldering. This will not improve the heat transfer and damage the soldering iron tip instead.
4. When placing the soldering iron back in the holder to idle after a high-temperature operation, adjust the temperature to 250°C (482°F) or below for idling. Failure to do so, and leaving the soldering iron tip to idle on a high-temperature setting will cause the accelerated aging of the heating element and shorten the lifespan of the heating element and soldering iron tip.

V. Operation Instructions

1. Changing Heating Element

Slot the soldering iron tip into the V-shaped groove (1-1), Pull the soldering iron to separate the heating element (1-2), Attach the new heating element to the soldering iron (1-3), Place the soldering iron tip into the hole and apply gentle pressure to secure the tip to the soldering iron (1-4).

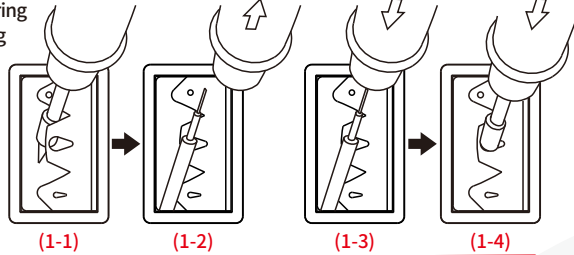

"Heating Element Not Detected" - This is an indication that the station's sensor module is faulty. You need to replace the heating element (the heating element and the sensor modules). Or, the soldering iron/heating element is not connected.

CAUTION: Upon the first use of the soldering iron, when the iron is just hot enough to melt solder, coat the soldering iron tip with a layer of solder (the use of rosin core solder is recommended).

WARNING: When replacing the heating element during the operation (heated), DO NOT touch the heating element or the groove to avoid potential burn injuries. DO NOT place an operational heating element on the heating element groove for an extended period.

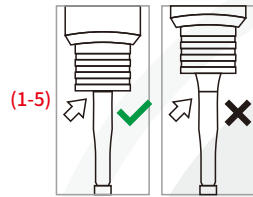

2. Before Use

Solder Wire Holder

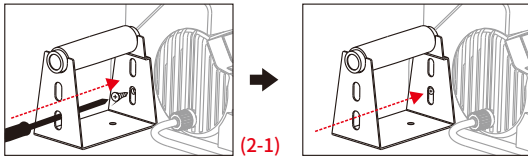

Helping Hands

1. Tighten the helping arm
2. Tighten the screw

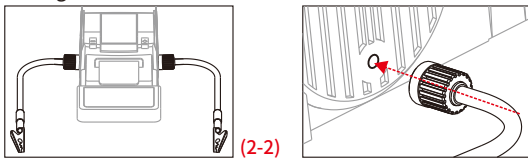

Connect the soldering iron and turn ON the master power switch.

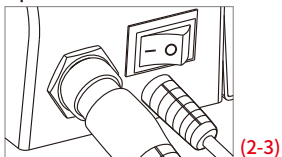

3. °F/°C Temperature Display

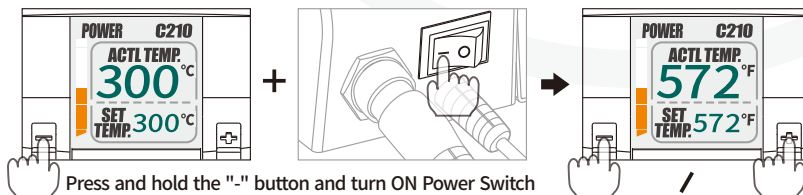

4. Sleep Mode and Stand-by Function

This function extends the lifespan of the heating element, conserves energy, and protects the environment.

When the soldering iron is placed back into the holder, the soldering iron will enter sleep mode (4-1). When the set temperature is 200°C/392°F or higher, the temperature will cool to 200°C/392°F; when the set temperature is below 200°C/392°F, the temperature will remain unchanged. Pick up the soldering iron to wake the station. When the station enters sleep mode for longer than approximately 5 minutes, the station will automatically enter the stand-by mode (4-2). Pick up the soldering iron to restart the soldering station.

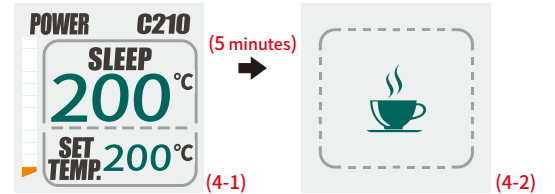

5. Cable Guide

Note: It is recommended to lean the cable guide backwards when installing.

Secure the cable guide and pull down the cable tie. Insert the cable to the slot of the cable guide and pull up the cable tie. The cable will be securely fastened.

6. Digital Temperature Calibration

Press and hold "+" and "-" buttons for approximately 2 seconds to enter the temp. calibration interface.

