



SPECIFICATION FOR APPROVAL

Customer : RCS Components LTD.
 Product name : AC ADAPTER (电源适配器)
 Customer Model No. :
 Customer Part No. :
 Supplier Model No. : FC06PA-120S050E2C
 Supplier Part No. :

CUSTOMER APPROVED SIGNATURE

Approved by:	Checked by:	Tested by:
Explain: Please return to us "SPECIFICATION FOR APPROVAL" with your approved signatures. (承认书确认后请回签一份)		

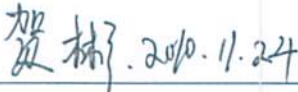
Supplier approval signature:

Prepared by:	Checked by:	Approved by:
 贺洁 2010.11.24	 黄景东 2010.11.24	 贺洁 2010.11.24



深圳市福瑞祥电器有限公司恒丰分厂
 SHENZHEN FEREX ELECTRICAL CO., LTD.

地址: 中国广东省深圳市宝安区西乡街道恒丰工业城 B7 栋 4-6 楼
 Add: 4-6F, B7 Building, Hengfeng industrial park, Huangtian village, Xixiang town, Bao'an district, Shenzhen, Guangdong, China.
 Tel: (0755) 27474030 27474044, 27474067, 27474073 Fax: (0755)27474076
 E-mail: hjliu@ferex.com.cn Website: <https://www.ferex.com.cn>

Table of contents

No.	Content	Page
0.	Revision control list	2
1.	Scope	3
2.	Input characteristics	3
3.	Output characteristics	3
4.	Energy Efficiency	3
5.	Protection characteristics	4
6.	Safety & EMC Standard	4
7.	Reliability & Quality control	4
8.	Environmental requirement	5
9.	Other requirements	5
10.	Mechanical characteristics:	5
11	Certificate:	
	APPENDIX A: Physical Dimensions	6
	APPENDIX B: Nameplate	7
	APPENDIX C: Packing	8
	APPENDIX D: Certificate	9

0. Revision control list:

Date	Description of Change	Revised by	Checked by	Approved by
2010-11-24	First release	贺彬	黄景东	刘红军



PRED. by	Hebin 2010-11-24	 福瑞祥 F E R E X	SHENZHEN FEREX ELECTRICAL CO.,LTD.	
CHKD. by	Hardy 2010-11-24			
APVD. by	H.J.LIU 2010-11-24	Model:FC06PA-120S050E2C	Rev.:1.0	Page2 Of 10

1. Scope:

This specification defines the input, output, performance characteristics, and environment, noise and safety requirements for a **6.0** watts output switching type power adapter. The adapter input/output are **100-240VAC** input and **+12.0V DC** with **0.5A** Normal output current.

2. Input characteristics:

Test item	Min.	Normal	Max.
AC input voltage	90 V	100-240 V	264 V
AC input frequency	47 Hz	50/60 Hz	63 Hz
AC input current	0.3A Max. @ 100-240Vac input		
Inrush current (cold)	No damage shall occur and the input fuse shall not blow up.		

3. Output characteristics:

Test item	Output	Test condition
Rated output voltage	+ 12.0 V	100-240 Vac input
Output voltage range	11.4V~12.6V	0A-0.5A output current & 230 Vac input
Min. output current	0 A	100-240 Vac input
Normal output current	0.5A	100-240 Vac input
Ripple	120mV Max.	0.5A output current & 230 Vac input
		* measured at the end of output cables which added a 0.1uF(104)ceramic capacitor and a 47uF electrolytic capacitor(connect parallel), measured with a 20MHz bandwidth.
Turn-on Delay Time	3.0S Max.	0.5A output current & 100-240 Vac input
Rise Time	30mS Max.	0.5A output current & 100-240 Vac input
Overshoot	5% Max.	0.5A output current & 100-240 Vac input
Remark: Unless otherwise specification output load must set at CR mode.		

4. Energy Efficiency

Item	Requirement	
No-load power consumption	0.3W Max.	100-240 Vac input & No-load
Efficiency	▮ 73.42 % Min.	0.5A output current & 230 Vac input
	▮ 73.42% Min. For average active mode.	100% /75% / 50% / 25% load & 115Vac/60Hz or 230 Vac/50Hz input

PRED. by	Hebin 2010-11-24	 福瑞祥 FEREX	SHENZHEN FEREX ELECTRICAL CO.,LTD.	
CHKD. by	Hardy 2010-11-24			
APVD. by	H.J.LIU 2010-11-24	Model:FC06PA-120S050E2C	Rev.:1.0	Page3 Of 10

5. Protection characteristics

Input fuse	<input type="checkbox"/> T1A 250Vac Fuse <input checked="" type="checkbox"/> 4.7R/1W Wire-wound Fuse-resistor
Short-Circuit protection	The adapter must withstand a continuous short circuit on the output without damage and Auto-recovery when short-circuit moved.
Over-Current protection	In Overload mode, The output must drop to a low voltage.

6. Safety & EMC Standard

The adapter designed to meet the following standards:

Safety standards	<input type="checkbox"/> (CHINA) CCC GB4943-2001 <input type="checkbox"/> (CHINA) CCC GB8898-2001 <input type="checkbox"/> (U.S.) UL 60950-1, 2007 <input type="checkbox"/> (U.S.) UL 60065-1, 2007 <input checked="" type="checkbox"/> (CE) LVD 2006/95/EC Directive IEC 60950-1/EN 60950-1 <input type="checkbox"/> (CE) LVD 2006/95/EC Directive IEC 60065/EN 60065
EMC Standards	<input type="checkbox"/> (CHINA) CCC GB9254-2008 <input type="checkbox"/> (CHINA) CCC GB13837-2003 <input type="checkbox"/> (CHINA) CCC GB17625.1-2003 <input type="checkbox"/> (U.S.) FCC part 15 Class B /ICES-003:CLASS B <input checked="" type="checkbox"/> (CE) EMC 2004/108/EC Directive EN55022/EN55024/EN61000-3-2:2006/EN61000-3-3 <input type="checkbox"/> (CE) EMC 2004/108/EC Directive EN55020/EN55013/EN61000-3-2:2006/EN61000-3-3
Hi-Pot	Primary To Secondary: <u>3000Vac 10mA</u> 1 minute or <u>4242Vdc 10mA</u> 1 minute.
Insulation Resistance	Primary To Secondary: <u>10M ohm</u> Min. at <u>500Vdc</u> .
Leakage Current	0.25mA Max. at 100-240 Vac input / 50-60Hz

7. Reliability & Quality control

Item	Requirement
MTBF	<u>>20000</u> Hours at 25 °C (Standard:MIL-HDBK-217F), <u>230</u> Vac input & <u>80%</u> Normal output current.
Burn-In	The power supply shall withstand a minimum of <u>2</u> hours Burn-In test at <u>230</u> Vac input & Normal output current with 35-40 °C room temperatures. After test, product shall operate normally.

PRED. by	Hebin 2010-11-24	 SHENZHEN FEREX ELECTRICAL CO.,LTD.		
CHKD. by	Hardy 2010-11-24			
APVD. by	HJ.LIU 2010-11-24	Model:FC06PA-120S050E2C	Rev.:1.0	Page4 Of 10

8. Environmental requirement

Item	Requirement
Operating Environmental	Temperature: 0°C - 40 °C Relative Humidity: 20%-85%,noncondensing Altitude: Sea level to 2,000 M.
Storage (Non-operating) Environmental	Temperature: -20°C - 60°C Relative Humidity: 5%-95%,noncondensing Altitude: Sea level to 2,000 M.
Cooling	Natural convection cooling
Vibration and Shock	(Non-operating, with packing) Reference to IEC 68-2-6 Frequency: 5-500 Hz Sweep:2hours,each axis (X, Y, Z) Acceleration: 0.6G (5~50 Hz, peak - peak), 1.5G (50~500 Hz, peak - peak) Displacement: 0.4 mm (5~50 Hz)

9. Other requirements

Item	Requirement
Hazardous substances	The components and materials shall be in compliance with <input checked="" type="checkbox"/> EU Directive 2002/95/EC "ROHS" <input checked="" type="checkbox"/> EU Directive 2002/96/ec "WEEE"

10. Mechanical characteristics:

Item	Requirement
Drop test	Dropped freely from 1 m(for wall mount product) height onto the surface is consisted of hardwood 13 mm thick, mounted on two layers of plywood each 19-20 mm thick, all supported on concrete floor once from 3 different surfaces. After testing, the product should not be damaged.
Physical dimensions	The detail dimension of product see APPENDIX A.
Input plug type	<input type="checkbox"/> Wall-mount type, CCC-pin, 2 Conductors, <Live, Neutral> <input checked="" type="checkbox"/> Wall-mount type, EU-pin, 2 Conductors, <Live, Neutral> <input type="checkbox"/> Wall-mount type, US-pin, 2 Conductors, <Line, Neutral>
Output connector	Wire: <u>UL2468 24AWG/2C 1500mm Black</u> Plug: (OD) <u>5.5mm</u> *(ID) <u>2.1mm</u> *(length) <u>10.0 mm</u> Center (+) <u>180°</u>
Nameplate	The detail information of Nameplate see APPENDIX B.
Packing	The detail information of packing see APPENDIX C.

11. Certificate:

Type of Certificate	<input type="checkbox"/> CCC <input checked="" type="checkbox"/> CE <input type="checkbox"/> GS <input type="checkbox"/> FCC <input type="checkbox"/> UL The detail information of packing see APPENDIX D.
---------------------	---

PRED. by	Hebin 2010-11-24	 福瑞祥 FEREX	SHENZHEN FEREX ELECTRICAL CO.,LTD.	
CHKD. by	Hardy 2010-11-24			
APVD. by	H.J.LIU 2010-11-24	Model:FC06PA-120S050E2C	Rev.:1.0	Page5 Of 10

APPENDIX A: Physical dimensions

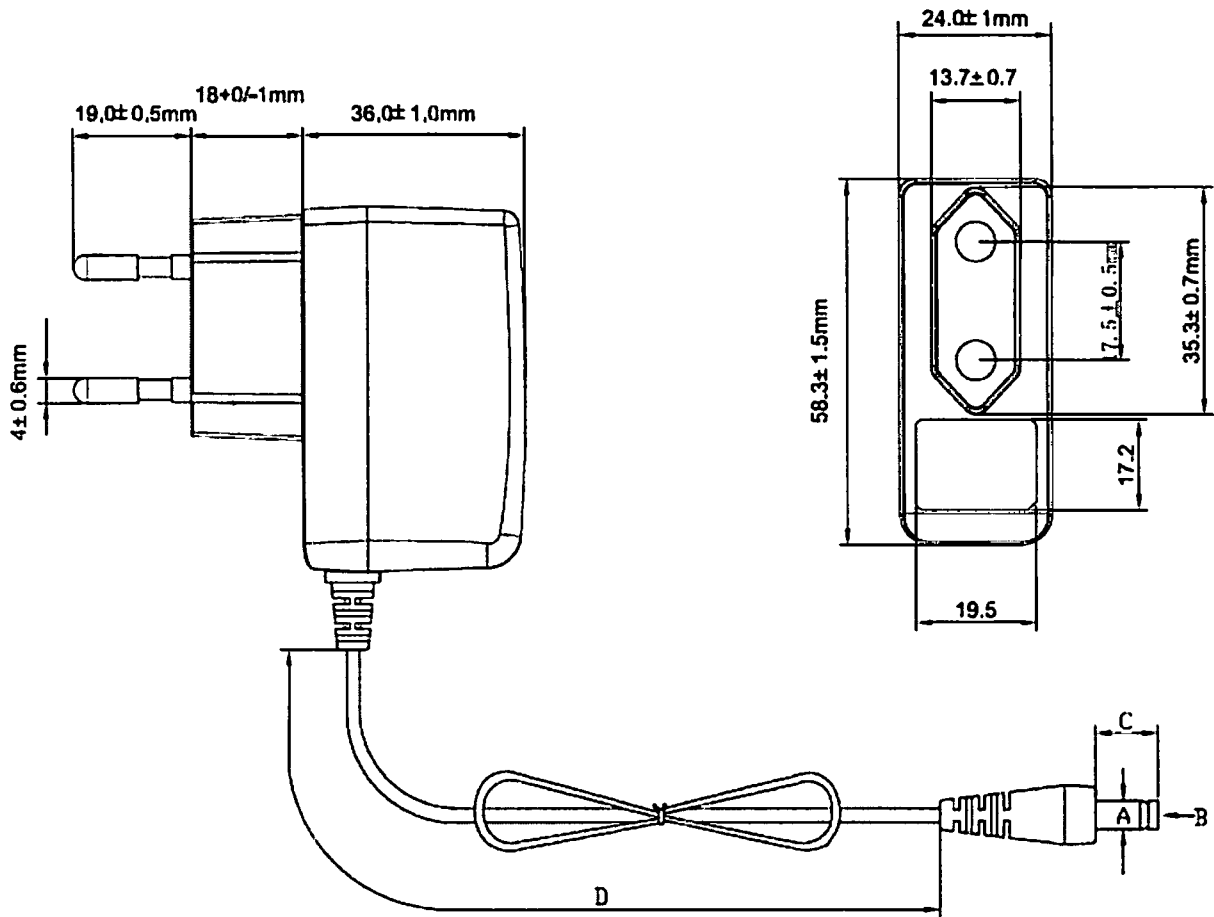

	∅A	∅B	C	D
DIMENSION	5.5	2.1	10	1500
TOLERANCE	±0.1	+0.1/-0	±0.5	Nor
REMARK	UL2464 24AWG/2C 300VAC 80°C BLACK			

DESCRIPTION		FC06PA-VDE	DESIGN BY.	Hebin	 UNIT: MM
REVISER		REV A0	CHECKED BY.		
DATE		2010-10-13	APPROVED BY.		

PRED. by	Hebin 2010-11-24	 福瑞祥 FEREX SHENZHEN FEREX ELECTRICAL CO.,LTD.		
CHKD. by	Hardy 2010-11-24			
APVD. by	HJ.LIU 2010-11-24	Model:FC06PA-120S050E2C	Rev.:1.0	Page6 Of 10

APPENDIX B: Nameplate

FILE NAME

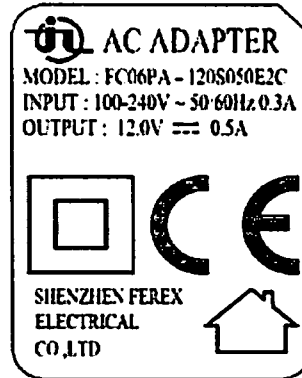
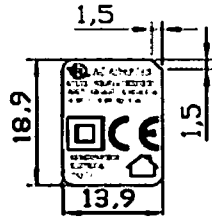

NOTES:

- 1.SCALE: 1/1;
- 2.Thickness: 0.1~0.2mm;
- 3.Tolerance+0/-0.2;
- 4.Material: 8#PP synthetic paper or better;
- 5.COLOR: White CHARACTERS ON BLACK;
- 6.OPERATING TEMPERATURE: -20C-80C.

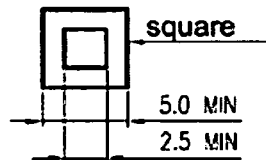

Department	Signature
Safety	
Sales	

UNIT TOLERANCE: X ± 3
XX ± 1

SCALE 1:1 ISSUED DATE 2010-11-10

DRAWN BY Hobin CHECKED BY

DESIGNED BY APPROVE BY

REV	DATE	DESCRIPTION	ECN NO
		ITEM NO :	DRAWING NO
			SHEET

PRED. by	Hebin 2010-11-24	 福瑞祥 SHENZHEN FEREX ELECTRICAL CO.,LTD.		
CHKD. by	Hardy 2010-11-24			
APVD. by	H.J.LIU 2010-11-24	Model:FC06PA-120S050E2C	Rev.:1.0	Page7 Of 10

APPENDIX C: Packing

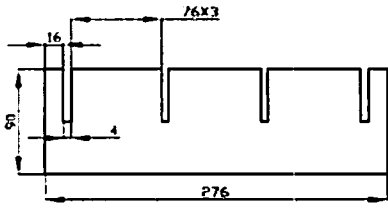

刀卡1

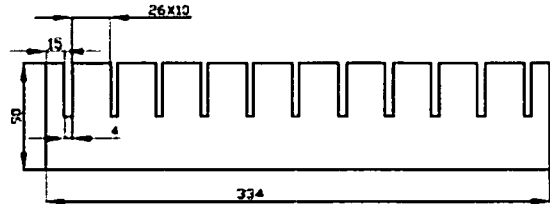

刀卡2

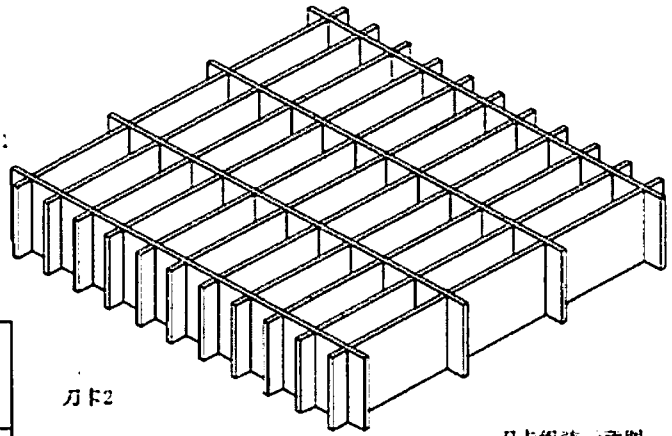

刀卡组装示意图

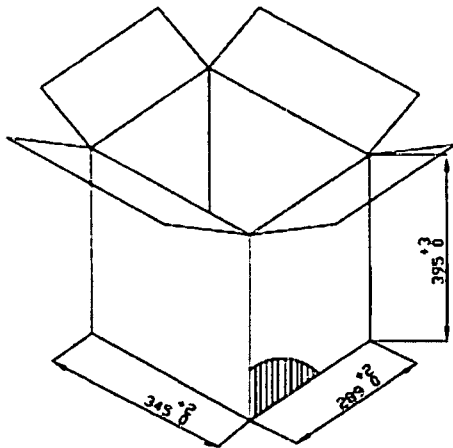

下进箱

箱唛

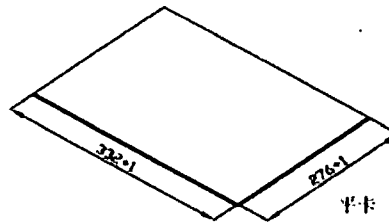

平卡

平卡

NOTE:

1. 纸箱材质为A=B, 每箱4层, 每层30台, 共计120台, 标示尺寸(345MM X 289MM X 395MM) 为外尺寸;
2. 平卡材质为B3B, 数量: 5片;
3. 刀卡1: 材质为B3B, 数量: 44片;
4. 刀卡2: 材质为B3B, 数量: 16片;
5. 注意波纹方向, 勿沿纹路纵向切割;
6. 接口钉合;
7. 进料前需先送样承认OK方可;
8. 使用材料要符合环保要求, 禁止使用危害物质;
9. 尺寸以标注为准, 切勿实际测量;
10. 刀卡的公差为1mm.

395MM	福瑞祥 开关电源·适配器 SMPS & ADAPTER 深圳市福瑞祥电器有限公司 SHENZHEN FEREX ELECTRICAL CO., LTD. 地址: 深圳市宝安区西乡街道铁岗社区铁岗山 电话: 0755-27011628 传真: 0755-27011629 网址: www.ferex.com.cn	 型号(MODEL): _____ 数量(QTY): _____ PCS 规格(SIZE): 345x289x395 MM 空箱回收	福瑞祥 开关电源·适配器 SMPS & ADAPTER 深圳市福瑞祥电器有限公司 SHENZHEN FEREX ELECTRICAL CO., LTD. 地址: 深圳市宝安区西乡街道铁岗社区铁岗山 电话: 0755-27011628 传真: 0755-27011629 网址: www.ferex.com.cn	 型号(MODEL): _____ 数量(QTY): _____ PCS 规格(SIZE): 345x289x395 MM 空箱回收
	345MM	289MM		

SHENZHEN FEREX ELECTRICAL, LTD			
DESCRIPTION	FAP005-DVE DC包装箱	DESIGN BY:	X.L.HUANG
REVISER	REV A0	CHECKED BY:	
DATE	2010-11-10	APPROVED BY:	
			 UNIT mm

PRED. by	Hebin 2010-11-24	福瑞祥 SHENZHEN FEREX ELECTRICAL CO., LTD.
CHKD. by	Hardy 2010-11-24	
APVD. by	H.J.LIU 2010-11-24	Model: FC06PA-120S050E2C Rev.: 1.0 Page 8 Of 10

APPENDIX D:Certificate



Certificate No.: E/EC3547100929179 (1 of 2)

for the following equipment:

Product Description: AC adapter
 Model No: See the attachments
 Rating(s): 100-240V~, 50/60Hz, 0.3A
 Trademark: 
 Applicant: Shenzhen Ferex Electrical Co., Ltd.
 1/5-8F, Blk 1, Bojuqianneng Industrial Park, 3rd Industrial Area of Lisonglang, Gongming Town, Baoan, Shenzhen, Guangdong 518106 China
 Manufacture: Shenzhen Ferex Electrical Co., Ltd.
 1/5-8F, Blk 1, Bojuqianneng Industrial Park, 3rd Industrial Area of Lisonglang, Gongming Town, Baoan, Shenzhen, Guangdong 518106 China
 Factory: Shenzhen Ferex Electrical Co., Ltd.
 1/5-8F, Blk 1, Bojuqianneng Industrial Park, 3rd Industrial Area of Lisonglang, Gongming Town, Baoan, Shenzhen, Guangdong 518106 China

is herewith confirmed to comply with the requirements of 2006/95/EC—Low Voltage Directive (LVD) and 93/68/EEC—CE Marking Directive.

Test standards: EN55022:2006+A1:2007 EN55024:1998+A1:2001+A2:2003
 EN61000-3-2:2006 EN61000-3-3:1995+A1:2001+A2:2005
 IEC60950-1:2005(2nd Edition) and/or N 60950-1:2006+A11:2009

Test report No.: Z1008CE8888-0208-S, Z1008CE8888-0208-E-01, Z1008CE8888-0208-E-02, Z1008CE8888-0208-E-03

Date of issue: 2010-09-29

Yang Lin (杨林)
 Director



CEPREI (Headquarters) Laboratory
 Add: No. 110 Dongguan 1st Road
 Tianhe District, Guangzhou 510610 P.R. China
 Http://www.ceprei.biz

PD 1531-07 02 510610 P.R.C

PRED. by	Hebin 2010-11-24	 福瑞祥 FEREX	SHENZHEN FEREX ELECTRICAL CO.,LTD.	
CHKD. by	Hardy 2010-11-24			
APVD. by	H.J.LIU 2010-11-24	Model:FC06PA-120S050E2C	Rev.:1.0	Page9 Of 10



Certificate No.: E/EC3547100929179 (2 of 2)

General product information:

FC06PA-XXSYYYZ2C ,

FC06PA-XXSYYYZ2U ,

XXX: can be 036-180 to denote output voltage: from 3.6V to 18.0V, the voltage step is 0.1V;

YYY: can be 005-100 to denote output current: from 0.05A to 1.0A, the current step is 10mA;

Z: can be C, U, E, K, B, BR, to denote different AC plug type;

C: cable output type;

U: USB interface output type;

Yang Lin (杨林)

Director



CEPREI (Headquarters) Laboratory
Add: No. 110 Dongguanzhou Road
Tianhe District, Guangzhou 510610 P.R. China
Http://www.ceprei.biz

PD 1501-07 GZ 110610 P.R.C

PRED. by	Hebin 2010-11-24		福瑞祥 F E R E X	SHENZHEN FEREX ELECTRICAL CO.,LTD.
CHKD. by	Hardy 2010-11-24			
APVD. by	H.J.LIU 2010-11-24	Model:FC06PA-120S050E2C	Rev.:1.0	Page10 Of 10