

BASE

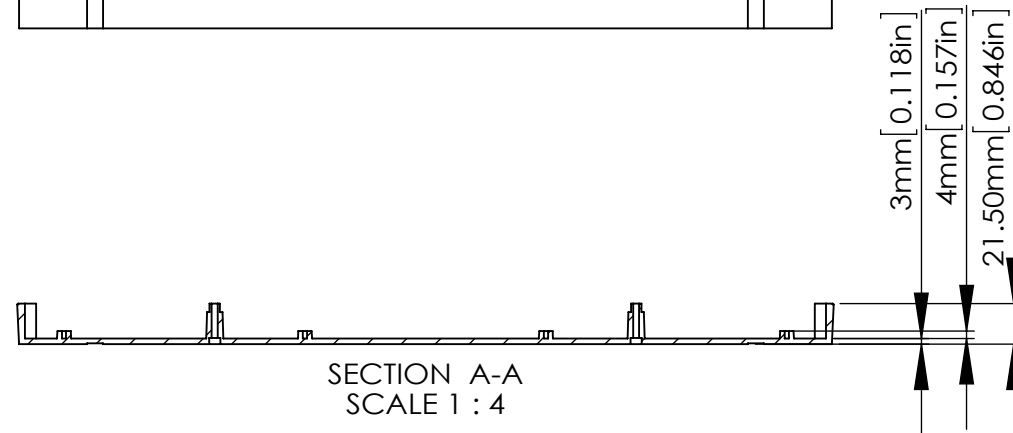

COVER

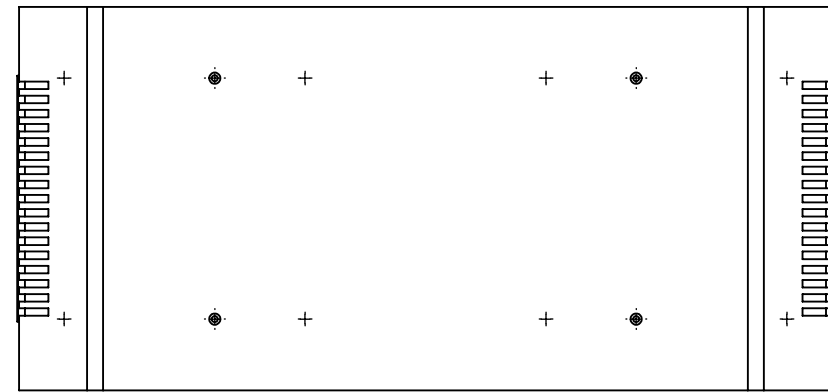
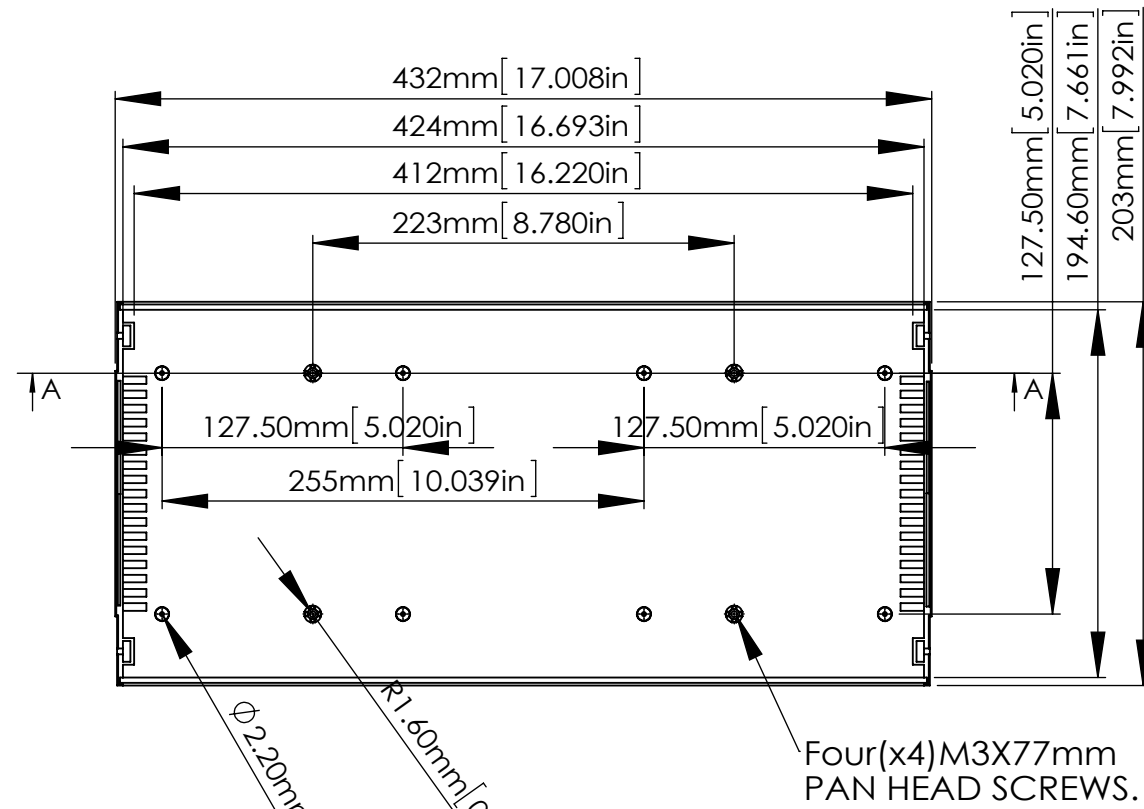
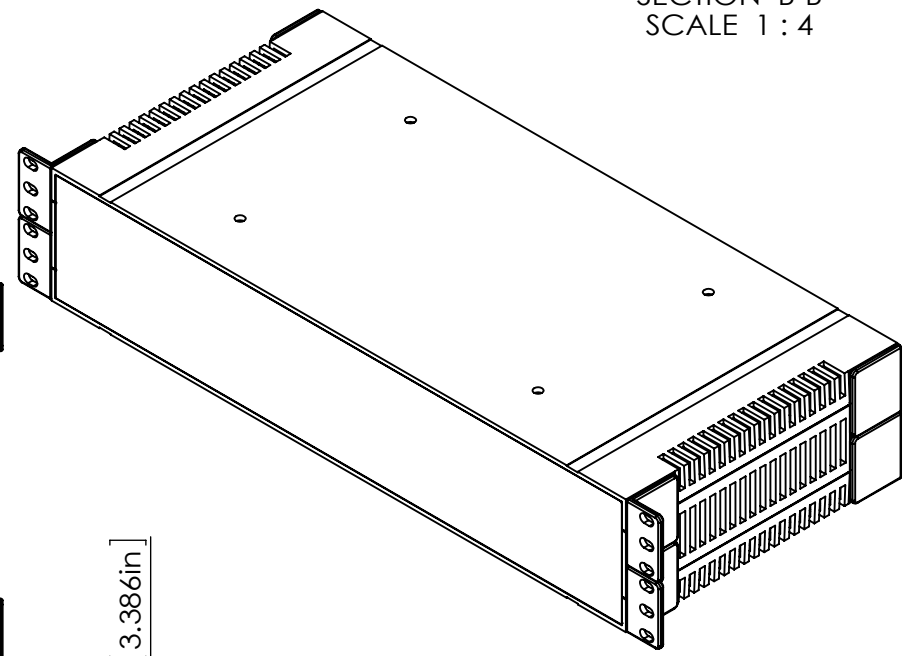
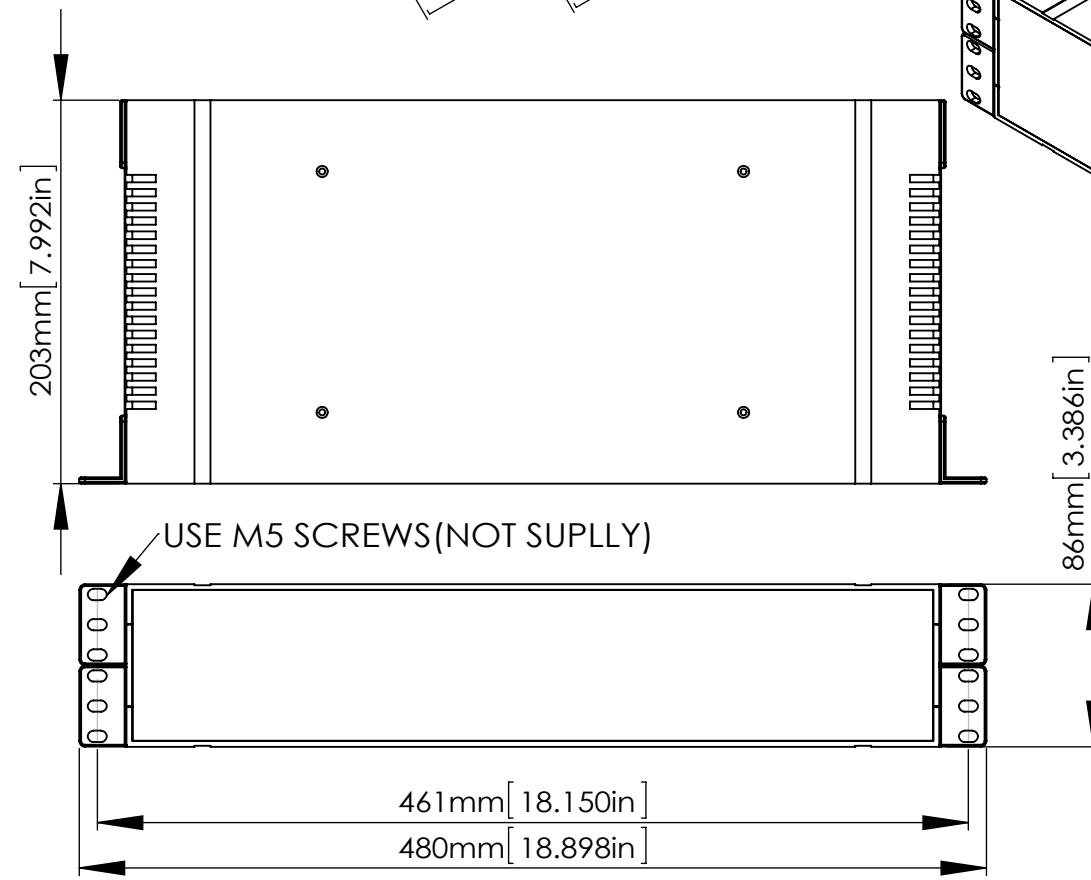
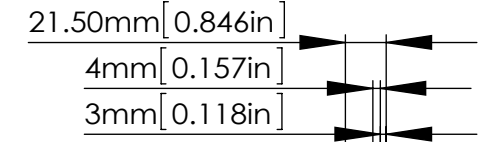
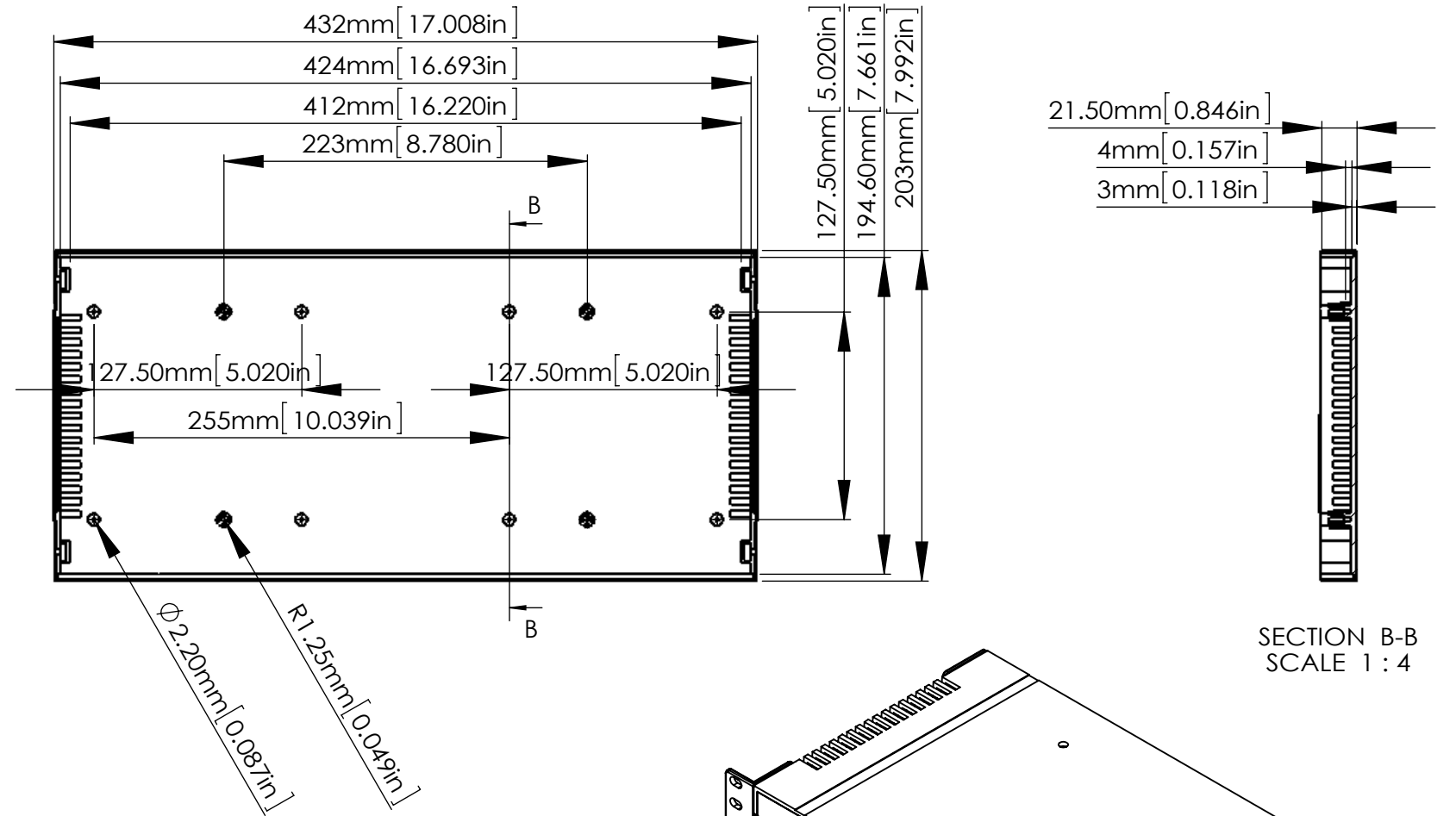

According to ISO 2768-m

Measuring DIM=L	Tolerances
0.5<L<=3.0mm	±0.1mm
3.0<L<=6.0 mm	±0.1mm
6.0<L<=30.0 mm	±0.2mm
30.0<L<=120.0 mm	±0.3mm
120.0<L<=400.0 mm	±0.5mm
400.0<L<=1000.0 mm	±0.8mm

ASSEMBLY

宣又實業有限公司  
GAINTA INDUSTRIES LTD.

繪圖 DRA'D BY  
JACKY

日期 DATE  
2025/05/27

材質 MATE.  
ABS UL94-HB

圖名TITLE:  
G17082UBK-HB ; G17082UG-HB

圖號DWG NO:

版次REVISED:  
A