

GNT-4031Ax-Bx (TRIPLE DIGIT LED DISPLAY)

GNT-4031 Series

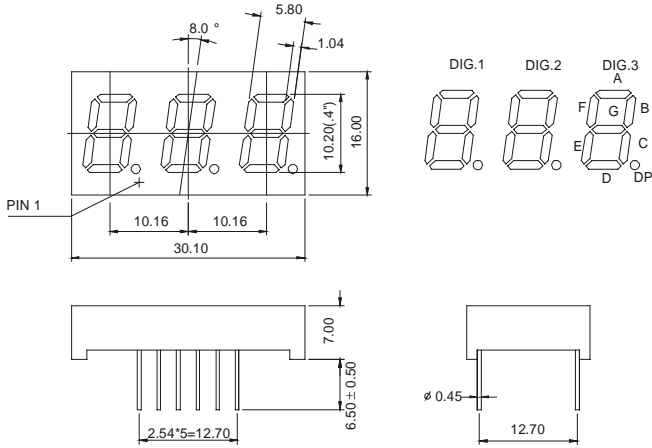

GNT-4031Ax

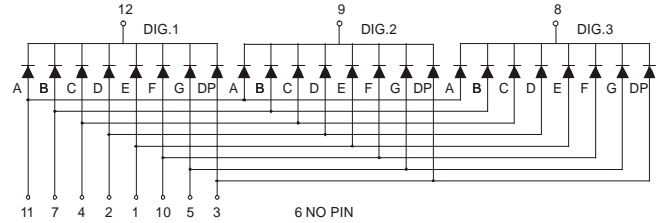

GNT-4031Bx

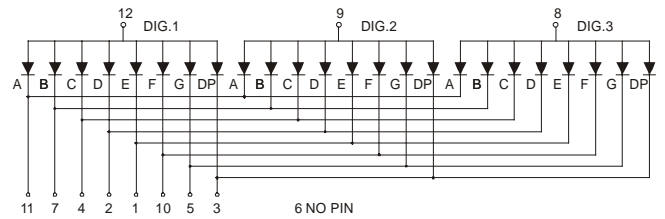

Features:

*0.40 INCH HIGH CHARACTER.

*EXCELLENT CHARACTER APPEARANCE.

*COMMON CATHODE OR COMMON ANODE.

*I.C. COMPATIBLE.

*LOW POWER CONSUMPTION.

Part Number	EMITTED COLOR		Common Cathode or Common Anode	Peak Wavelength (nm)	Vf (v) Typ	If (mA)	Intensity Per Segment (mcd)	
							Min.	Typ.
GNT-4031AE	GaAsP/GaP	Hi.effi Red	Common Cathode	635	2.0	20	9	12
GNT-4031AG	GaP	Green		565	2.1	20	8	11
GNT-4031AY	GaAsP/GaP	Yellow		585	2.0	20	9	12
GNT-4031AS	GaAlAs	Super Red		660	1.8	20	10	13
GNT-4031AD	GaAlAs	Ultra Red		660	1.8	20	25	30
GNT-4031AUE	AlGaInP	Ultra Red		625	2.0	20	30	35
GNT-4031AUY	AlGaInP	Ultra Yellow		590	2.0	20	30	35
GNT-4031BE	GaAsP/GaP	Hi.effi Red	Common Anode	635	2.0	20	9	12
GNT-4031BG	GaP	Green		565	2.1	20	8	11
GNT-4031BY	GaAsP/GaP	Yellow		585	2.0	20	9	12
GNT-4031BS	GaAlAs	Super Red		660	1.8	20	10	13
GNT-4031BD	GaAlAs	Ultra Red		660	1.8	20	25	30
GNT-4031BUE	AlGaInP	Ultra Red		625	2.0	20	30	35
GNT-4031BUY	AlGaInP	Ultra Yellow		590	2.0	20	30	35