

Constant current LED driver for high-power LED



FEATURES

- High efficiency up to 97%
- Ultra wide input voltage range (6-36 VDC)
- Output current stability ($\pm 1\%$)
- Drive current: 300/350/700/1000/1200 mA
- Continuous short-circuit protection
- PWM / Analogue Dimming
- Remote On/Off, continuous short-circuit protection
- Operating ambient temperature range: -40°C to 85°C

KC24H-xxxR3 series are high efficiency BUCK constant current source for Led driving design. The converters feature high efficiency, wide input voltage range, high temperature working environment, complete functions. Products include PWM / Analogue Dimming Remote On/Off functions. Products can be widely used in backlight and automobile 12V, 24V lighting, landscape lighting, measurement lighting, commercial lighting, street lighting, family lighting.

Selection Guide

Certification	Part No.	Input Voltage (VDC)	Output		Nominal half load	Capacitive Load (μF) Max.
		Nominal (Range)	Voltage (VDC)	Current (mA)	Typ./Max.input full load Typ.(%)	
EN/BS EN	KC24H-300R3	24 (6-36)	3.3-33	300	93/97	1000
	KC24H-350R3			350	93/96	
	KC24H-700R3			700	93/96	
	KC24H-1000R3			1000	94/96	
	KC24H-1200R3			1200	95/96	

Input Specifications

Item	Operating Conditions	Min.	Typ.	Max.	Unit
Input Voltage Limit	<10 seconds	0	--	38	VDC
Input-output Voltage Drop		2	3	--	
Input Filter		Capacitance filter			
Hot Plug		Unavailable			

Output Specifications

Item	Operating Conditions	Min.	Typ.	Max.	Unit
Output Power	KC24H-300R3, $I_o=300\text{mA}$	--	--	9.9	W
	KC24H-350R3, $I_o=350\text{mA}$	--	--	11.6	
	KC24H-700R3, $I_o=700\text{mA}$	--	--	23.1	
	KC24H-1000R3, $I_o=1000\text{mA}$	--	--	33.0	
	KC24H-1200R3, $I_o=1200\text{mA}$	--	--	39.6	
Current Accuracy	$V_{in}=36\text{V}$, 1-10 LEDs	--	± 2	± 5	%
Current Stability	$V_{in}=36\text{V}$, 1-10 LEDs	--	--	± 1	
Temperature Coefficient	KC24H-300/350/700R3	-40°C to $+85^{\circ}\text{C}$	--	--	
	KC24H-1000/1200R3	-40°C to $+85^{\circ}\text{C}$	--	--	± 0.03

Ripple & Noise*	Vin=36V, 1-10 LEDs	KC24H-300/350/700R3	--	45	100	mVp-p
		KC24H-1000/1200R3	--	70	200	
Internal power consumption	Vin=24V, 5 LEDs		--	--	1.2	W
Short-circuit Protection		Continuous, self-recovery				
Note: * The "parallel cable" method is used for Ripple and Noise test, please refer to DC-DC Converter Application Notes for specific information;						

General Specifications

Item	Operating Conditions	Min.	Typ.	Max.	Unit
Operating Temperature	KC24H-300/350/700/1000/1200R3	-40	--	85	°C
Storage Temperature		-55	--	125	
Switching Frequency	KC24H-300/350/700R3	--	600	--	kHz
	KC24H-1000/1200R3	--	300	--	
MTBF	MIL-HDBK-217F@25°C	1000	--	--	k hours

Mechanical Specifications

Case Material	Black plastic; flame-retardant and heat-resistant (UL94V-0)				
Dimensions	KC24H-300/350/700R3	22.80 x 10.20 x 9.00mm			
	KC24H-1000/1200R3	31.70 x 20.30 x 12.65mm			
Weight	KC24H-300/350/700R3	4.2g(Typ.)			
	KC24H-1000/1200R3	14.5g(Typ.)			
Cooling Method	Free air convection				

PWM Dimming

Remote On/Off	Off	Pulled low (0 < Vc < 0.75VDC)			
	On	Open or pulled high (> 5VDC)			
PWM dimming frequency		--	--	200	Hz
Turn-off-mode Static Input Current	Vin=24V, Vc<0.6V	--	400	--	µA

Analogue Dimming

Input voltage range	Vin=6-36V	0-15V			
Output current range	Vin=6-36V	0%-100%			
Control Voltage Range	On	0.75V ± 50mV			
	Off	4.7V ± 200mV			

Electromagnetic Compatibility (EMC)

Emissions	CE	CISPR32/EN55032	CLASS B (see Fig. 8-② for recommended circuit)		
	RE	CISPR32/EN55032	CLASS B (see Fig. 8-② for recommended circuit)		
Immunity	ESD	IEC/EN 61000-4-2	Contact ±4kV		perf. Criteria B
	RS	IEC/EN 61000-4-3	10V/m		perf. Criteria B
	EFT	IEC/EN 61000-4-4	±1kV	(see Fig. 8-① for recommended circuit)	perf. Criteria B
	Surge	IEC/EN 61000-4-5	±1kV	(see Fig. 8-① for recommended circuit)	perf. Criteria B
	CS	IEC/EN 61000-4-6	3Vr.m.s		perf. Criteria B

Typical Characteristic Curves

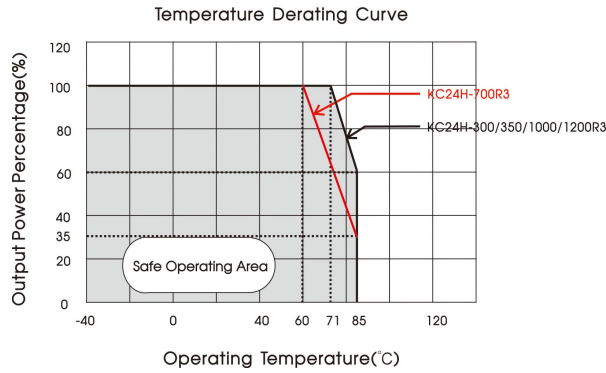
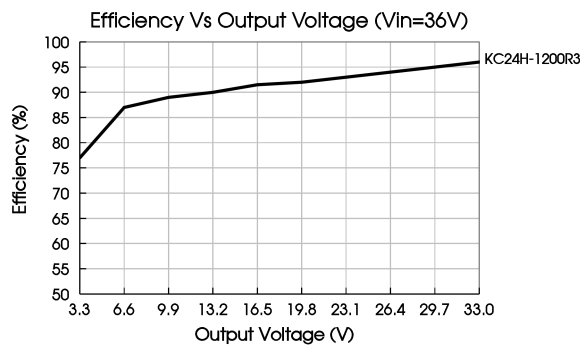

Fig. 1



Design Reference

1. Input and output

Table 1 input and output

Input voltage	Output Voltage range
36 VDC	2.8-33.0 VDC
24 VDC	2.8-18.0 VDC
6 VDC	2.8-3.3 VDC

2. Typical application circuit

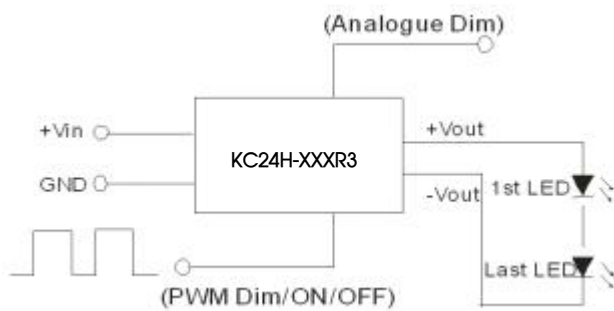

Fig. 2 Series application

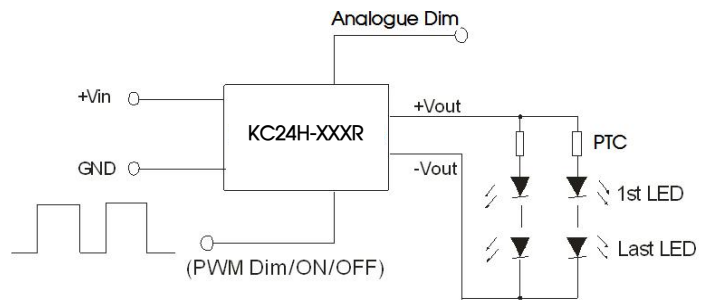

Fig. 3 Parallel application

In actual use, if need to protect the LED, please add a PTC with a positive temperature coefficient in front of each branch as shown in Figure 3.

Note: The -Vout cannot be grounded, otherwise the product will be damaged.

3. PWM Dimming

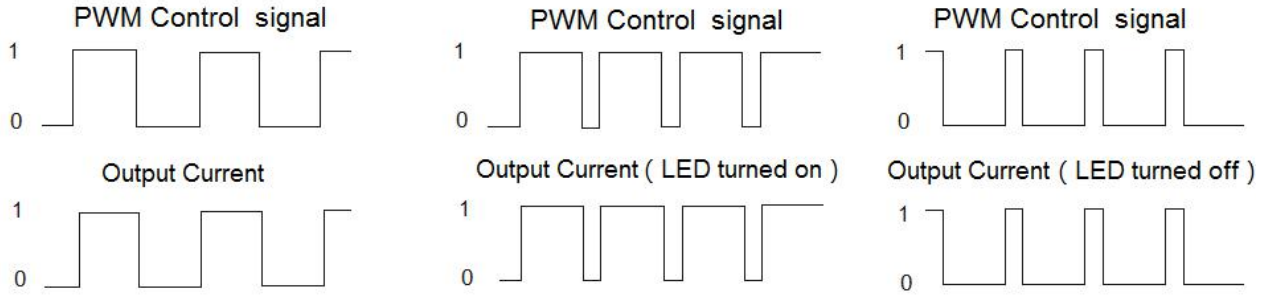

Fig. 4 PWM Dimming control

For PWM dimming of a certain frequency, the output current of the driver is proportional to the duty cycle of the PWM signal, and the brightness of the LED can be adjusted by controlling the duty cycle of the PWM signal.

PWM Dimming positive logic application circuit diagram

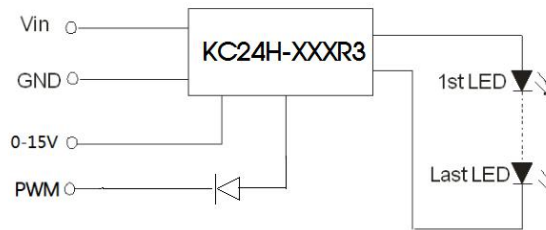

Fig. 5 PWM Dimming control circuit diagram

For PWM dimming at a certain frequency, the output current of the driver is proportional to the duty cycle of the PWM signal, please refer to the following formula for the calculation:

$$I_{o_set} = (D - 0.02) \cdot I_{o_norm}$$

I_{o_set} : the desired output current value (mA),

D: the duty cycle of the PWM signal (%)

T: the period of the PWM signal (ms)

I_{o_norm} : the rated output value of the driver (mA).

Note: The above formula is for reference only, and the output current may vary due to different loads. The minimum on-time of the PWM signal cannot be less than 0.75ms, otherwise the product will not work normally. It is normal to hear a slight sound from the driver during PWM dimming, because the PWM dimming frequency is within the auditory frequency range of the human ear (usually 20Hz-20KHz). In order to prevent the human eyes from observing the flicker of the LED, it is recommended to set the PWM dimming frequency above 200Hz. PWM voltage shall be free of spikes.

PWM voltage needs to be free of spikes.

4. Analogue Dimming and typical applications

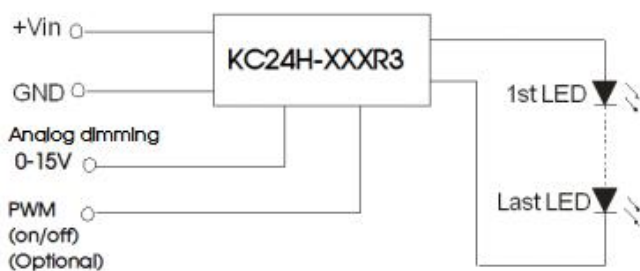

Fig. 6 Analogue Dimming circuit diagram

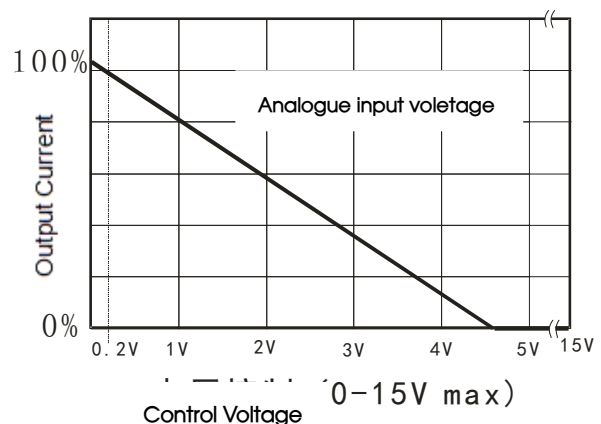
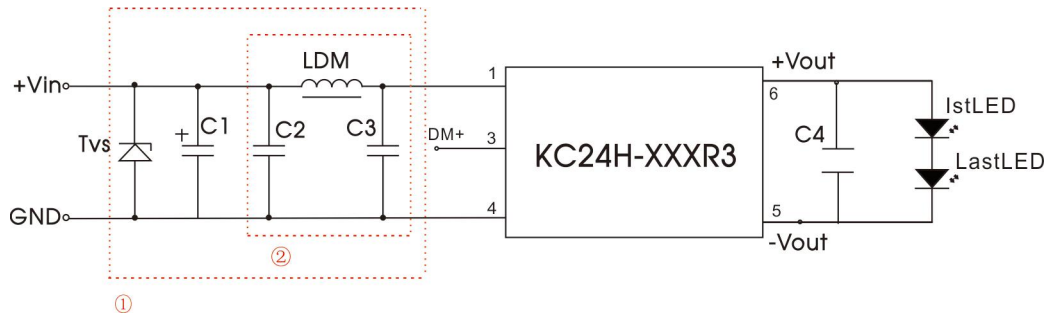
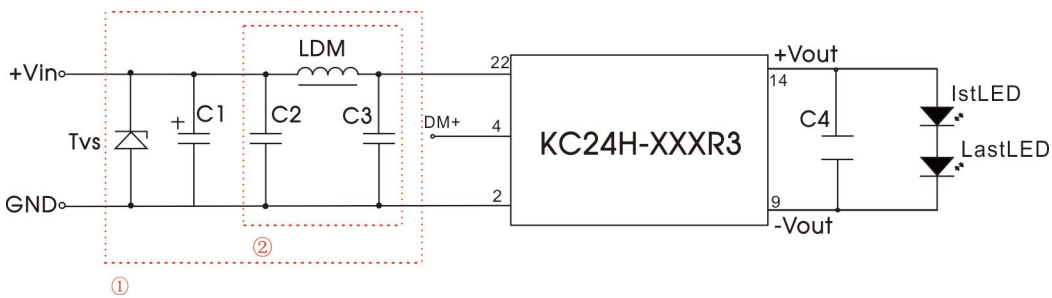

Fig. 7 Analogue input voltage and output current

5. EMC solution-recommended circuit



KC24H-300/350/700R3



KC24H-1000/1200R3

Fig. 8 EMC recommended circuit

Table. 2 EMC components list

Components	Specification
Tvs	SMC51A, 1500W (GOODARK)
LDM	CD53-82μH (CEAIYA)
C1	1000μF /63V (NCC)
C2	2.2μF /50V 1210 X7R (TORCH)
C3	0.1μF /50V 0805 X7R (TORCH)
C4	1μF /50V 1210 X7R (TORCH)

6. The rated voltage drop of all LED in this technical manual is 2.8-3.3V. In practical application, the number of LED can be determined according to the actual voltage drop and output voltage of LED

7. The product does not support hot swap

8. For additional information please refer to DC-DC converter application notes on www.mornsun-power.com

Dimensions and Recommended Layout

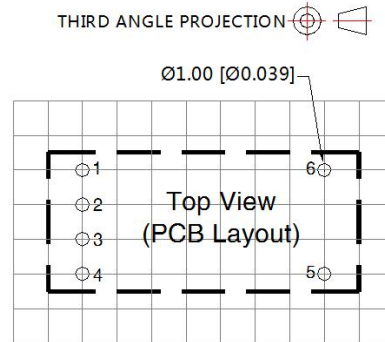
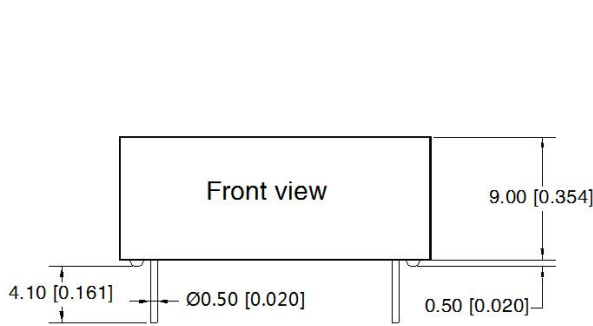

Note: Grid 2.54*2.54mm

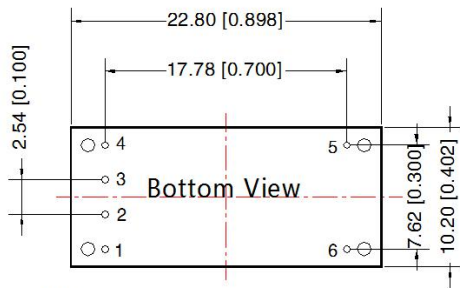

Note:
Unit: mm[inch]
Pin diameter tolerances: ± 0.10 [± 0.004]
General tolerances: ± 0.25 [± 0.010]

PIN CONNECTION		
Pin	Mark	Comment
1	Vin	DC Supply
2	Analog dimming	Leave open if not use
3	On/Off/PWM	Leave open if not use
4	GND	Do not connect to -Vout
5	-Vout	LED Cathode connection
6	+Vout	LED Anode connection

KC24H-300/350/700R3

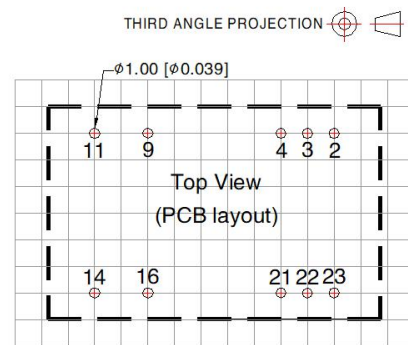
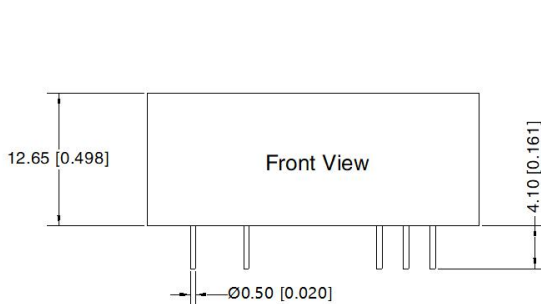

Note: Grid 2.54*2.54mm

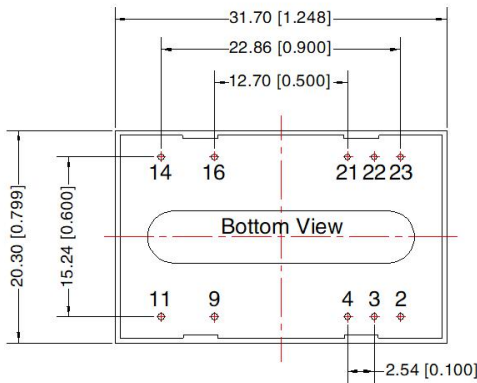

Note:
Unit: mm[inch]
Pin diameter tolerances: ± 0.10 [± 0.004]
General tolerances: ± 0.25 [± 0.010]

PIN CONNECTION		
Pin	Mark	Comment
2,3	GND	Do not connect to -Vout
4	On/Off/PWM	Leave open if no use
9,11	-Vout	LED Cathode connection
14,16	+Vout	LED Anode connection
21	Analog Dimming	Leave open if no use
22,23	Vin	DC Supply

KC24H-1000/1200R3

Notes:

1. For additional information on Product Packaging please refer to www.mornsun-power.com. Tape/Reel packaging bag number: KC24H-300/350/700R3: 58210025, KC24H-1000/1200R3: 58000150;
2. Unless otherwise specified, parameters in this datasheet were measured under the conditions of $T_a=25^{\circ}\text{C}$, humidity<75%RH with nominal input voltage and rated output load;
3. All index testing methods in this datasheet are based on our company corporate standards;
4. We can provide product customization service, please contact our technicians directly for specific information;
5. Products are related to laws and regulations: see "Features" and "EMC";
6. Our products shall be classified according to ISO14001 and related environmental laws and regulations, and shall be handled by qualified units.

MORNSUN Guangzhou Science & Technology Co., Ltd.

Address: No. 5, Kehui St. 1, Kehui Development Center, Science Ave., Guangzhou Science City, Huangpu District, Guangzhou, P. R. China
Tel: 86-20-38601850 Fax: 86-20-38601272 E-mail: info@mornsun.cn www.mornsun-power.com