

# Product Specification

Number: L-KLS4-WH148-1B-2-18T  
-B102-L15

Name: Rotary Potentiometer

Customer: B37

Date: 2023-8-5

Customer Signature:



**NINGBO KLS ELECTRONIC CO; LTD**

Tel : 0086-574-86828566

Fax : 0086-574-86824882

ADD : NO. 8-1, RONGXIA RD. XIAPU SHANQIAN  
INDUSTRIAL ZONE BEILUN NINGBO ZHEJIANG.

Compi	Check	Review	Approva
Jenny	Jack.C		

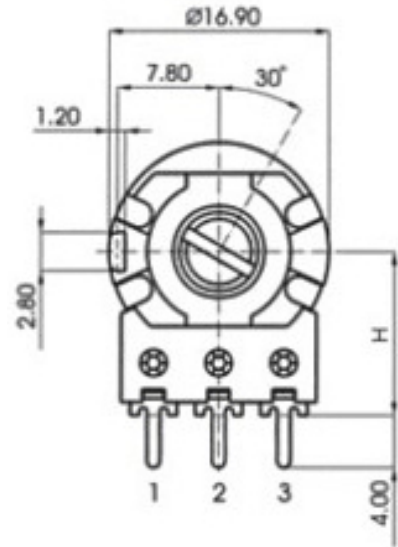
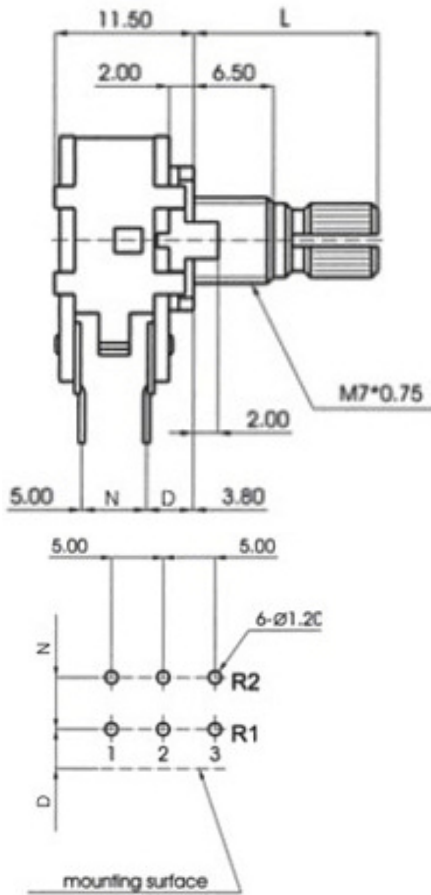

SHAFT SHOWN IN FULL C.C.W. POSITION

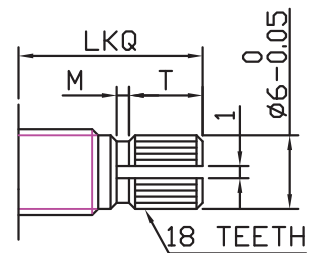
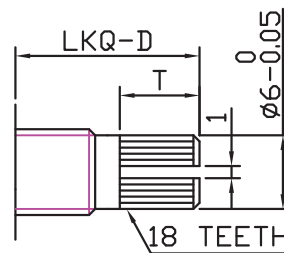
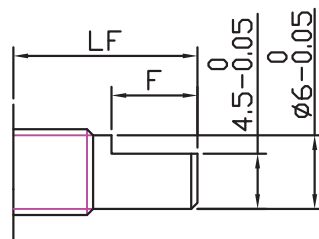
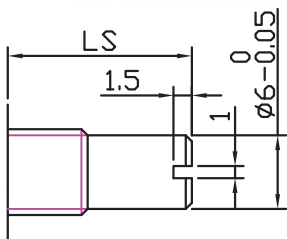

S TYPE

X	L <sub>s</sub>		
0	10		
1	12		
2	15		
3	20		
4	25		
5	30		

F TYPE

X	L <sub>F</sub>	F	
A	15	7	
B	20	10	
C	25	12	
D	30	12	

KQ-D TYPE

X	L <sub>KQ-D</sub>	T
1	12	3.5
2	15	6.5
3	20	11.5
4	25	18.5
5	30	23.5
17	17	8.5

KQ TYPE

X	L <sub>KQ</sub>	T	M
0	10	2.3	0.3
1	12	3.5	0.5
2	15	6	1
3	20	10	2
4	25	12	2
5	30	12	2
16.5	16.5	7.5	1

1			NAME	Rotary Potentiometer		
2						
3						
NO	DATE	DESCRIPTION	DRAWING NO	L-KLS4-WH148-1B-2-18T-B102-L15		
TOLERANCE		SCALE	DRAWN BY	CHECK BY	APPROVED BY	
less than 10 ±0.3		1.5:1				
above 10-30 ±0.5		DIMENSION				
above 30-100 ±1.0		mm	<b>NINGBO KLS ELECTRONIC CO; LTD</b>			

1. 一般事項 General.

1.1 適用範圍：此規範適用於電子機器之可變電阻器。

Application: This specification is applied to potentiometers used for electronic equipment.

1.2 使用溫度範圍 Operating temperature: -10~+55°C

1.3 試驗狀態：若無特別規定限制，則以溫度5~35°C、相對濕度45~85%、氣壓860~1060 mbar 之標準狀態測之。但對此標準狀態之測定值發生判定疑問或有特殊要求則以基準狀態。(溫度20±2°C、相對濕度65±5%、氣壓860~1060 mbar)為準測定。)

Test conditions: the standard test conditions shall be 5~35°C in temperature, 45~85%RH and 860~1060 mbar in atmospheric, should any doubt arise in judgment, tests shall be conducted at 20±2°C、65±5%RH and 860~1060 mbar.

2. 構造、尺寸 Construction and dimensions:

依組立圖 Refer to attached drawing.

3. 電氣性能 Electrical characteristics

NO.	項目 Items	試驗條件 Test conditions	規格 Specifications
3.01	全阻抗值 Total resistance and tolerance	測定端子1-3端子間的阻抗值。 Measurement shall be made by the resistance between terminal 1 and 3.	全阻抗值： <u>20K</u> 误差：■ ±10% □ ±20% total resistance： <u>20K</u> tolerance：■ ±10% □ ±20%
3.02	額定電力 Power rating	端子1和3間所能連續負荷之最大電力。 Power rating is based on continuous full load operation at the maximum voltage between terminal 1 and terminal 3.	B特性曲線：0.2W 其他特性曲線：0.1W B taper:0.2W other taper:0.1W
3.03	額定電壓 Rated voltage	Rated voltage 額定電壓 $E = \sqrt{PR}$ (V) P:Power rating 額定電力 (W) R:Nominal total resistance 公稱全阻抗值(Ω) 當額定電壓超過最高使用電壓的時候，最高使用電壓即為額定電壓。 When the rated voltage exceeds the maximum operating voltage, the maximum operating voltage shall be the rated voltage.	B特性曲線：200V AC 其他特性曲線：150V AC B taper:200V AC other taper:150V AC
3.04	接觸阻抗 Contact resistance	使用1KHz±200Hz(最大20mV, 50mA)及5V DC, 1A 壓降法測試 Shall be measured at 1KHz±200Hz(Max 20mV, 50mA) or 5V DC, 1A by a voltage drop method.	不大於 50mΩ Less than 50mΩ
3.05	開關功率 Switch power	開關所能承受的最大電壓和電流 The switch can take maximum voltage and current	AC 250V 1A
3.06	阻抗變化特性 Taper	電壓法測定 Measurement shall be made by the resistance law method	請參照特性曲線一覽表 Resistance taper list

1			PREPARED BY	REVIEWED BY	APPROVED BY
2					
3					
4					
NO.	DATE	DESCRIPTION			

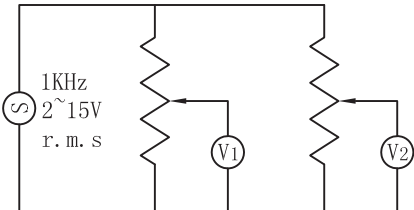
NO.	項目 Items	試驗條件 Test conditions	規格 Specifications
3.07	絕緣阻抗 Insulation resistance	施加500V 之直流電壓，測試1分鐘。 測試位置：端子和外殼、端子和軸心間。 Applying 500V DC measure for 1 minute. Applied position:Between terminal and frame. Between terminal and shaft.	100MΩ 以上 (MIN)
3.08	耐電壓 Voltage proof	施加500V 之交流電壓，測試1分鐘。 測試位置：端子和外殼、端子和軸心間。 Applying 500V AC measure for 1 minute. Applied position:Between terminal and frame. Between terminal and shaft.	不可有損傷、電弧、絕緣破壞 Without damage to parts arcing or breakdown.
3.09	殘留阻抗 Residual resistance	滑動子置於移動距離的兩末端時，端子1-2間、端子2-3間的阻抗值測定。 The resistances at each end of the mechanical between terminal 1 and 2, terminal 2 and 3 shall be measured.	1-2T: 10Ω 以下 (MAX) 2-3T: 10Ω 以下 (MAX)
3.10	滑動雜音 Slider noise	端子1-3間印加直流電壓20V (額定電壓20V以下時，則印加此額定電壓)，以60° /秒的移動速度所測定之雜音 Applying 20V DC between the terminals 1 and 3. (When the rated voltage is small than the 20V DC, it shall be applied the rated voltage. And then the noise shall be measured by the specified speed 60° /sec.  *瞬間雜音及抽頭位置之雜音不計。 *帶CC定位點機種時，定位點位置雜音除外。  *The section noise and tap position noise are excepted. *In with click type, the click position noise is excepted.	Less than 47 mV 小于 47 mV
3.11	同步誤差 Gang error	按下圖接線方式測試 It should be tested at the following drawing  	不適用 Not applicable

1			PREPARED BY	REVIEWED BY	APPROVED BY
2					
3					
4					
NO.	DATE	DESCRIPTION			

4. 機械性能 Mechanical characteristic

NO.	項目 Items	試驗條件 Test conditions	規格 Specifications
4.01	全旋轉角度 Total rotation angle		300° ± 10°
4.02	作動力 Operating force	旋轉速度: 60° /秒 操作位置: 軸心前端5mm處 Rotation speed:60° /sec. Operating position:5mm from shaft end.	20~150gf. cm
	始動力 Starting force	旋轉速度: 60° /秒 操作位置: 軸心前端5mm處 Rotation speed:60° /sec. Operating position:5mm from shaft end.	作動力+100gf以下 Operating force +100gf MAX.
4.03	旋轉止檔強度 Rotation stopper strength	測試時間: 旋轉至1腳端和3腳端各10±1秒。 Test duration:rotate to terminal 1 and terminal 3 specifically for 10±1 sec.	大於5kgf. cm More than 5kgf. cm
4.04	軸推拉強度 Push-pull strength of shaft	測試時間: 使用推力10秒後立即再使用拉力20秒。 測試點及方向: 測試點為軸心頂部, 方向為軸向。 Test duration:10 sec. of push force immediately followed by 20 sec. of pull force should be applied. Test point and direction:the strength should be applied to the top end of the shaft in axial direction.	大於8kgf More than 8kgf
4.05	軸心晃動 Shaft wobble	在距離軸心頂端5mm處施加與軸心垂直的力。 Apply force perpendicular to the shaft at the position of 5mm to be top end of the shaft.	0.7*L/30mm Max. L-軸心長度 L-shaft length
4.06	軸向間隙 Shaft play in axial	沿軸心的軸向施加5kgf的拉拔力 Apply 5kgf of force to the shaft in axial direction	0.5mm
4.07	軸套螺牙強度 Bushing nut tightening strength	軸套匹配螺母後施加扭力。 Apply torsion force for bushing matching nut	金屬軸套: 大於7kgf. cm 塑膠軸套: 大於5kgf. cm Metal bushing: more than 7 kgf. cm Plastic bushing: more than 5 kgf. cm
4.08	端子強度 Terminal strength	靜態負荷1kgf於端子的頂端, 測試時間為一分鐘。測試數量為一個產品的端子數。 A static load of 1kgf.cm shall be applied to the tip of the terminal in a desired direction for one minute.The number of tests shall be one per terminal.	端子無變形、鬆動 Terminal without distortion and loose

1			PREPARED BY	REVIEWED BY	APPROVED BY
2					
3					
4					
NO.	DATE	DESCRIPTION			

5. 耐久性 Durability

NO.	項目 Items	試驗條件 Test conditions	規格 Specifications
5.01	使用壽命 (無負載)  Operating life under no load	開關部分：10000個週期, 運行期間不間斷, 運行速度每分鐘10~15次。 電位器部分：15000個週期, 運行期間不間斷, 運行速度每分鐘10~15次。  Switch:10,000 cycles of operation shall be performed continuously at a rate of 10~15 cycles per minute without load After operating life test ,shall be in accordance with the following specifications.  Potentiometers :15,000 cycles of operation shall be performed continuously at a rate of 10~15 cycles per minute without load After operating life test ,shall be in accordance with the following specifications.	全阻變化小於±10% 接觸阻抗小於200mΩ 絕緣電阻大於50MΩ 耐電壓250V AC測試1分鐘 操作力不超出+10%~-30% 初始力  Total resistance:less than±10% Contact resistance: less than 200mΩ Insulation resistance: more than 50MΩ Withstand voltage: 250V AC per 1 minute Operating force: less than +10%~-30% for initial operating force
5.02	使用壽命 (負載)  Operating life under load	開關部分：10000個週期, 運行期間不間斷, 運行速度每分鐘10~15次, 使用AC 250V 1A的負載進行。 電位器部分：15000個週期, 運行期間不間斷, 運行速度每分鐘10~15次。使用小於0.2W的負載進行。  Switch:10,000 cycles of operation shall be performed continuously at a rate of 10~15 cycles per minute with resistive load of AC 250V 1A After operating life test ,shall be in accordance with the following specifications.  Potentiometers :15,000 cycles of operation shall be performed continuously at a rate of 10~15 cycles per minute with resistive load of 0.2W MAX. ,shall be in accordance with the following specifications.	全阻變化小於±10% 接觸阻抗小於500mΩ 絕緣電阻大於50MΩ 耐電壓250V AC測試1分鐘 操作力不超出+10%~-30% 初始力  Total resistance:less than±10% Contact resistance: less than 500mΩ Insulation resistance: more than 50MΩ Withstand voltage: 250V AC per 1 minute Operating force: less than +10%~-30% for initial operating force

1			PREPARED BY	REVIEWED BY	APPROVED BY
2					
3					
4					
NO.	DATE	DESCRIPTION			

6. 耐候性 Weather performance

NO.	項目 Items	試驗條件 Test conditions	規格 Specifications
6.01	濕度測試 Humidity test	使用溫度 $40\pm 2^{\circ}\text{C}$ ，濕度90~95%RH的測試條件240小時後，放置也常溫下一小時後進行測試。 Texting porentiometers being kept in the conditions at $40\pm 2^{\circ}\text{C}$ and 90~95%RH for 240 hours in anormal ambient condition for an hour. then to be measured with in an hour.	通過以上的測試，該產品能達到以下要求： 絕緣測試：DC 500V電壓，不小於 $50\text{M}\Omega$ 耐壓測試：使用AC 250V電壓，測試一分鐘，不可有損傷、電弧、絕緣破壞，其他規格要求變化小於 $\pm 20\%$
6.02	高溫測試 Heat test	使用溫度 $70\pm 2^{\circ}\text{C}$ 的測試條件16小時後，放置也常溫下一小時後進行測試。 Texting porentiometers being kept in the conditions at $70\pm 2^{\circ}\text{C}$ in temperature for 16 hours in anormal ambient condition for an hour. then to be measured with in an hour.	Through the above tests, the product can achieve: Insulation resistance: More than $50\text{M}\Omega$ at 500V DC
6.03	低溫測試 Cold test	使用溫度 $-10\pm 2^{\circ}\text{C}$ 的測試條件16小時後，放置也常溫下一小時後進行測試。 Texting porentiometers being kept in the conditions at $-10\pm 2^{\circ}\text{C}$ in temperature for 16 hours in anormal ambient condition for an hour. then to be measured with in an hour.	Withstand voltage: For 1 minute or more at 250V AC, without damage to parts arcing or breakdown. Other requirements change less than $\pm 20\%$ .

7. 焊接耐熱性 Resistance to soldering heat

7.01	焊接耐熱性 Resistance to soldering heat	※DIP 焊錫條件：Condition of DIP soldering: 1. 清漬焊錫處理時，請確保在下列條件下作業： 1. Soldering shall be certified with following condition.		全阻抗值變化在初期的 $\pm 5\%$ 以內。端子不可有接觸不良或明顯鬆動。  Change in total resistance is relative to the value before test $\pm 5\%$ . Without excessive looseness of terminals and failure contact.
		預熱溫度 Preheat temperature	(印刷基板之RV固定面溫度) $100^{\circ}\text{C}$ 以下，2分鐘以內。 (Surface temperature of mounting side) $100^{\circ}\text{C}$ MAX Within 2 MIN.	
		焊錫溫度 Solder temperature	$260^{\circ}\text{C} \pm 5^{\circ}\text{C}$ ，5秒以內。 $260^{\circ}\text{C} \pm 5^{\circ}\text{C}$ ，Within 5 sec.	
		手焊溫度 Manual solder temperature	$350^{\circ}\text{C} \pm 5^{\circ}\text{C}$ ，3秒以內。 $350^{\circ}\text{C} \pm 5^{\circ}\text{C}$ ，Within 3 sec.	
		2. 以上工程1次通過即可。 Please use the above process only one times.		

1			PREPARED BY	REVIEWED BY	APPROVED BY
2					
3					
4					
NO.	DATE	DESCRIPTION			

POTENTIOMETERS PATTERN OF RESISTANCE CURVE

The Sample Correspondence Specification is 0B

