

# MC78M00, MC78M00A, NCV78M00 Series

## 500 mA Positive Voltage Regulators

The MC78M00/MC78M00A Series positive voltage regulators are identical to the popular MC7800 Series devices, except that they are specified for only half the output current. Like the MC7800 devices, the MC78M00 three-terminal regulators are intended for local, on-card voltage regulation.

Internal current limiting, thermal shutdown circuitry and safe-area compensation for the internal pass transistor combine to make these devices remarkably rugged under most operating conditions. Maximum output current, with adequate heatsinking is 500 mA.

### Features

- No External Components Required
- Internal Thermal Overload Protection
- Internal Short Circuit Current Limiting
- Output Transistor Safe-Area Compensation
- MC78M00A High Accuracy ( $\pm 2\%$ )  
Available for 5.0 V, 8.0 V, 12 V and 15 V
- NCV Prefix for Automotive and Other Applications Requiring Unique Site and Control Change Requirements; AEC-Q100 Qualified and PPAP Capable
- These are Pb-Free Devices

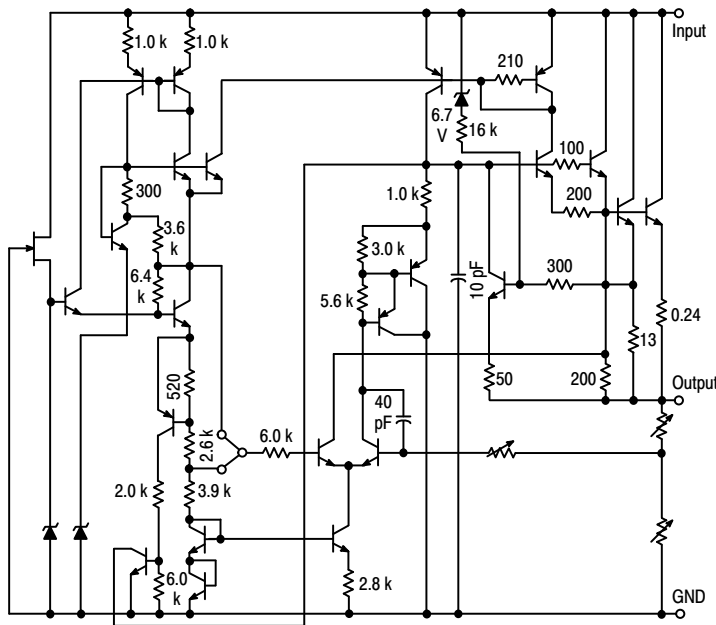

This device contains 28 active transistors.

Figure 1. Representative Schematic Diagram



ON Semiconductor®

<http://onsemi.com>

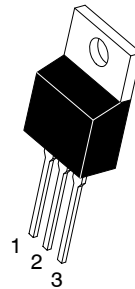

TO-220  
T SUFFIX  
CASE 221AB

Heatsink surface  
connected to Pin 2.

### MARKING DIAGRAMS

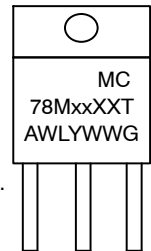

xx = Voltage Option  
XX = Appropriate Suffix Options  
A = Assembly Location  
WL = Wafer Lot  
Y = Year  
WW = Work Week  
G = Pb-Free Package

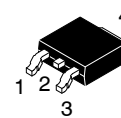

DPAK-3  
DT SUFFIX  
CASE 369C

Heatsink surface (shown as terminal 4 in  
case outline drawing) is connected to Pin 2.

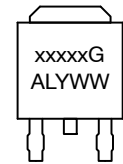

xxxxx = Device Type and Voltage Option Code  
A = Assembly Location  
L = Wafer Lot  
Y = Year  
WW = Work Week  
G = Pb-Free Package

Pin 1. Input  
2. Ground  
3. Output

### ORDERING INFORMATION

See detailed ordering and shipping information in the package dimensions section on page 10-14 of this data sheet.

### DEVICE MARKING INFORMATION

See general marking information in the device marking section on page 10 of this data sheet.

## MC78M00, MC78M00A, NCV78M00 Series

### MAXIMUM RATINGS ( $T_A = 25^\circ\text{C}$ , unless otherwise noted) (Note 1)

Rating	Symbol	Value	Unit
Input Voltage (5.0 V–18 V) (20 V–24V)	$V_I$	35 40	Vdc
Power Dissipation (Package Limitation) Plastic Package, T Suffix $T_A = 25^\circ\text{C}$ Thermal Resistance, Junction-to-Air Thermal Resistance, Junction-to-Case Plastic Package, DT Suffix $T_A = 25^\circ\text{C}$ Thermal Resistance, Junction-to-Air Thermal Resistance, Junction-to-Case	$P_D$ $\theta_{JA}$ $\theta_{JC}$ $P_D$ $\theta_{JA}$ $\theta_{JC}$	Internally Limited 70 5.0 Internally Limited 92 5.0	$^\circ\text{C}/\text{W}$
Operating Junction Temperature Range	$T_J$	+150	$^\circ\text{C}$
Storage Temperature Range	$T_{stg}$	-65 to +150	$^\circ\text{C}$

Stresses exceeding Maximum Ratings may damage the device. Maximum Ratings are stress ratings only. Functional operation above the Recommended Operating Conditions is not implied. Extended exposure to stresses above the Recommended Operating Conditions may affect device reliability.

- This device series contains ESD protection and exceeds the following tests:  
Human Body Model 2000 V per MIL-STD-883, Method 3015.  
Machine Model Method 200 V.

### MC78M05C/AC/B/AB, NCV78M05AB/B ELECTRICAL CHARACTERISTICS

( $V_I = 10\text{ V}$ ,  $I_O = 350\text{ mA}$ ,  $T_J = T_{low}$  to  $T_{high}$ ,  $P_D \leq 5\text{ W}$ , unless otherwise noted) (Note 2)

Characteristics	Symbol	Min	Typ	Max	Unit
Output Voltage ( $T_J = 25^\circ\text{C}$ ) MC78M05B/MC78M05C/NCV78M05B MC78M05AB/MC78M05AC/NCV78M05AB	$V_O$	4.8 4.9	5.0 5.0	5.2 5.1	Vdc
Output Voltage Variation ( $7.0\text{ Vdc} \leq V_I \leq 20\text{ Vdc}$ , $5.0\text{ mA} \leq I_O \leq 350\text{ mA}$ ) MC78M05B/MC78M05C/NCV78M05B MC78M05AB/MC78M05AC/NCV78M05AB	$V_O$	4.75 4.80	– –	5.25 5.20	Vdc
Line Regulation ( $T_J = 25^\circ\text{C}$ , $7.0\text{ Vdc} \leq V_I \leq 25\text{ Vdc}$ , $I_O = 200\text{ mA}$ )	$\text{Reg}_{line}$	–	3.0	50	mV
Load Regulation ( $T_J = 25^\circ\text{C}$ , $5.0\text{ mA} \leq I_O \leq 500\text{ mA}$ ) ( $T_J = 25^\circ\text{C}$ , $5.0\text{ mA} \leq I_O \leq 200\text{ mA}$ )	$\text{Reg}_{load}$	– –	20 10	100 50	mV
Input Bias Current ( $T_J = 25^\circ\text{C}$ )	$I_{IB}$	–	3.2	6.0	mA
Quiescent Current Change ( $8.0\text{ Vdc} \leq V_I \leq 25\text{ Vdc}$ , $I_O = 200\text{ mA}$ ) ( $5.0\text{ mA} \leq I_O \leq 350\text{ mA}$ )	$\Delta I_{IB}$	– –	– –	0.8 0.5	mA
Output Noise Voltage ( $T_A = 25^\circ\text{C}$ , $10\text{ Hz} \leq f \leq 100\text{ kHz}$ )	$V_n$	–	40	–	$\mu\text{V}$
Ripple Rejection ( $I_O = 100\text{ mA}$ , $f = 120\text{ Hz}$ , $8.0\text{ V} \leq V_I \leq 18\text{ V}$ ) ( $I_O = 300\text{ mA}$ , $f = 120\text{ Hz}$ , $8.0 \leq V_I \leq 18\text{ V}$ , $T_J = 25^\circ\text{C}$ )	RR	62 62	– 80	– –	dB
Dropout Voltage ( $T_J = 25^\circ\text{C}$ )	$V_I - V_O$	–	2.0	–	Vdc
Short Circuit Current Limit ( $T_J = 25^\circ\text{C}$ , $V_I = 35\text{ V}$ )	$I_{OS}$	–	350	–	mA
Average Temperature Coefficient of Output Voltage ( $I_O = 5.0\text{ mA}$ )	$\Delta V_O / \Delta T$	–	$\pm 0.2$	–	$\text{mV}/^\circ\text{C}$
Peak Output Current ( $T_J = 25^\circ\text{C}$ )	$I_O$	–	700	–	mA

- $T_{low} = 0^\circ\text{C}$  for MC78MxxAC, C  
=  $-40^\circ\text{C}$  for MC78MxxAB, B, NCV78MxxAB, B  
 $T_{high} = +125^\circ\text{C}$  for MC78MxxAB, AC, B, C, NCV78MxxAB, B

## MC78M00, MC78M00A, NCV78M00 Series

### MC78M06C/B ELECTRICAL CHARACTERISTICS

( $V_I = 11\text{ V}$ ,  $I_O = 350\text{ mA}$ ,  $T_J = T_{\text{low}}$  to  $T_{\text{high}}$ ,  $P_D \leq 5.0\text{ W}$ , unless otherwise noted) (Note 3)

Characteristics	Symbol	Min	Typ	Max	Unit
Output Voltage ( $T_J = 25^\circ\text{C}$ )	$V_O$	5.75	6.0	6.25	Vdc
Output Voltage Variation ( $8.0\text{ Vdc} \leq V_I \leq 21\text{ Vdc}$ , $5.0\text{ mA} \leq I_O \leq 350\text{ mA}$ )	$V_O$	5.7	–	6.3	Vdc
Line Regulation ( $T_J = 25^\circ\text{C}$ , $8.0\text{ Vdc} \leq V_I \leq 25\text{ Vdc}$ , $I_O = 200\text{ mA}$ )	$\text{Reg}_{\text{line}}$	–	5.0	50	mV
Load Regulation ( $T_J = 25^\circ\text{C}$ , $5.0\text{ mA} \leq I_O \leq 500\text{ mA}$ ) ( $T_J = 25^\circ\text{C}$ , $5.0\text{ mA} \leq I_O \leq 200\text{ mA}$ )	$\text{Reg}_{\text{load}}$	–	20 10	120 60	mV
Input Bias Current ( $T_J = 25^\circ\text{C}$ )	$I_{\text{IB}}$	–	3.2	6.0	mA
Quiescent Current Change ( $9.0\text{ Vdc} \leq V_I \leq 25\text{ Vdc}$ , $I_O = 200\text{ mA}$ ) ( $5.0\text{ mA} \leq I_O \leq 350\text{ mA}$ )	$\Delta I_{\text{IB}}$	–	–	0.8 0.5	mA
Output Noise Voltage ( $T_A = 25^\circ\text{C}$ , $10\text{ Hz} \leq f \leq 100\text{ kHz}$ )	$V_n$	–	45	–	$\mu\text{V}$
Ripple Rejection ( $I_O = 100\text{ mA}$ , $f = 120\text{ Hz}$ , $9.0\text{ V} \leq V_I \leq 19\text{ V}$ ) ( $I_O = 300\text{ mA}$ , $f = 120\text{ Hz}$ , $9.0\text{ V} \leq V_I \leq 19\text{ V}$ , $T_J = 25^\circ\text{C}$ )	RR	59 59	– 80	– –	dB
Dropout Voltage ( $T_J = 25^\circ\text{C}$ )	$V_I - V_O$	–	2.0	–	Vdc
Short Circuit Current Limit ( $T_J = 25^\circ\text{C}$ , $V_I = 35\text{ V}$ )	$I_{\text{OS}}$	–	350	–	mA
Average Temperature Coefficient of Output Voltage ( $I_O = 5.0\text{ mA}$ )	$\Delta V_O/\Delta T$	–	$\pm 0.2$	–	$\text{mV}/^\circ\text{C}$
Peak Output Current ( $T_J = 25^\circ\text{C}$ )	$I_O$	–	700	–	mA

### MC78M08C/AC/B/AB, NCV78M08B ELECTRICAL CHARACTERISTICS

( $V_I = 14\text{ V}$ ,  $I_O = 350\text{ mA}$ ,  $T_J = T_{\text{low}}$  to  $T_{\text{high}}$ ,  $P_D \leq 5\text{ W}$ , unless otherwise noted) (Note 3)

Characteristics	Symbol	Min	Typ	Max	Unit
Output Voltage ( $T_J = 25^\circ\text{C}$ ) MC78M08B/MC78M08C/NCV78M08B MC78M08AB/MC78M08AC	$V_O$	7.70 7.84	8.0 8.0	8.30 8.16	Vdc
Output Voltage Variation ( $10.5\text{ Vdc} \leq V_I \leq 23\text{ Vdc}$ , $5.0\text{ mA} \leq I_O \leq 350\text{ mA}$ ) MC78M08B/MC78M08C/NCV78M08B MC78M08AB/MC78M08AC	$V_O$	7.6 7.7	– –	8.4 8.3	Vdc
Line Regulation ( $T_J = 25^\circ\text{C}$ , $10.5\text{ Vdc} \leq V_I \leq 25\text{ Vdc}$ , $I_O = 200\text{ mA}$ )	$\text{Reg}_{\text{line}}$	–	6.0	50	mV
Load Regulation ( $T_J = 25^\circ\text{C}$ , $5.0\text{ mA} \leq I_O \leq 500\text{ mA}$ ) ( $T_J = 25^\circ\text{C}$ , $5.0\text{ mA} \leq I_O \leq 200\text{ mA}$ )	$\text{Reg}_{\text{load}}$	–	25 10	160 80	mV
Input Bias Current ( $T_J = 25^\circ\text{C}$ )	$I_{\text{IB}}$	–	3.2	6.0	mA
Quiescent Current Change ( $10.5\text{ Vdc} \leq V_I \leq 25\text{ Vdc}$ , $I_O = 200\text{ mA}$ ) ( $5.0\text{ mA} \leq I_O \leq 350\text{ mA}$ )	$\Delta I_{\text{IB}}$	–	–	0.8 0.5	mA
Output Noise Voltage ( $T_A = 25^\circ\text{C}$ , $10\text{ Hz} \leq f \leq 100\text{ kHz}$ )	$V_n$	–	52	–	$\mu\text{V}$
Ripple Rejection ( $I_O = 100\text{ mA}$ , $f = 120\text{ Hz}$ , $11.5\text{ V} \leq V_I \leq 21.5\text{ V}$ ) ( $I_O = 300\text{ mA}$ , $f = 120\text{ Hz}$ , $11.5\text{ V} \leq V_I \leq 21.5\text{ V}$ , $T_J = 25^\circ\text{C}$ )	RR	56 56	– 80	– –	dB
Dropout Voltage ( $T_J = 25^\circ\text{C}$ )	$V_I - V_O$	–	2.0	–	Vdc
Short Circuit Current Limit ( $T_J = 25^\circ\text{C}$ , $V_I = 35\text{ V}$ )	$I_{\text{OS}}$	–	350	–	mA
Average Temperature Coefficient of Output Voltage ( $I_O = 5.0\text{ mA}$ )	$\Delta V_O/\Delta T$	–	$\pm 0.2$	–	$\text{mV}/^\circ\text{C}$
Peak Output Current ( $T_J = 25^\circ\text{C}$ )	$I_O$	–	700	–	mA

3.  $T_{\text{low}} = 0^\circ\text{C}$  for MC78MxxAC, C  
 =  $-40^\circ\text{C}$  for MC78MxxAB, B, NCV78MxxAB, B  
 $T_{\text{high}} = +125^\circ\text{C}$  for MC78MxxAB, AC, B, C, NCV78MxxAB, B

## MC78M00, MC78M00A, NCV78M00 Series

### MC78M09C/B ELECTRICAL CHARACTERISTICS

( $V_I = 15\text{ V}$ ,  $I_O = 350\text{ mA}$ ,  $T_J = T_{\text{low}}$  to  $T_{\text{high}}$ ,  $P_D \leq 5.0\text{ W}$ , unless otherwise noted) (Note 4)

Characteristics	Symbol	Min	Typ	Max	Unit
Output Voltage ( $T_J = 25^\circ\text{C}$ )	$V_O$	8.64	9.0	9.45	Vdc
Output Voltage Variation ( $11.5\text{ Vdc} \leq V_I \leq 23\text{ Vdc}$ , $5.0\text{ mA} \leq I_O \leq 350\text{ mA}$ )	$V_O$	8.55	–	9.45	Vdc
Line Regulation ( $T_J = 25^\circ\text{C}$ , $11.5\text{ Vdc} \leq V_I \leq 25\text{ Vdc}$ , $I_O = 200\text{ mA}$ )	$\text{Reg}_{\text{line}}$	–	6.0	50	mV
Load Regulation ( $T_J = 25^\circ\text{C}$ , $5.0\text{ mA} \leq I_O \leq 500\text{ mA}$ ) ( $T_J = 25^\circ\text{C}$ , $5.0\text{ mA} \leq I_O \leq 200\text{ mA}$ )	$\text{Reg}_{\text{load}}$	–	25 10	180 90	mV
Input Bias Current ( $T_J = 25^\circ\text{C}$ )	$I_{\text{IB}}$	–	3.2	6.0	mA
Quiescent Current Change ( $11.5\text{ Vdc} \leq V_I \leq 25\text{ Vdc}$ , $I_O = 200\text{ mA}$ ) ( $5.0\text{ mA} \leq I_O \leq 350\text{ mA}$ )	$\Delta I_{\text{IB}}$	–	–	0.8 0.5	mA
Output Noise Voltage ( $T_A = 25^\circ\text{C}$ , $10\text{ Hz} \leq f \leq 100\text{ kHz}$ )	$V_n$	–	52	–	$\mu\text{V}$
Ripple Rejection ( $I_O = 100\text{ mA}$ , $f = 120\text{ Hz}$ , $12.5\text{ V} \leq V_I \leq 22.5\text{ V}$ ) ( $I_O = 300\text{ mA}$ , $f = 120\text{ Hz}$ , $12.5\text{ V} \leq V_I \leq 22.5\text{ V}$ , $T_J = 25^\circ\text{C}$ )	RR	56 56	– 80	– –	dB
Dropout Voltage ( $T_J = 25^\circ\text{C}$ )	$V_I - V_O$	–	2.0	–	Vdc
Short Circuit Current Limit ( $T_J = 25^\circ\text{C}$ , $V_I = 35\text{ V}$ )	$I_{\text{OS}}$	–	350	–	mA
Average Temperature Coefficient of Output Voltage ( $I_O = 5.0\text{ mA}$ )	$\Delta V_O / \Delta T$	–	$\pm 0.2$	–	$\text{mV}/^\circ\text{C}$
Peak Output Current ( $T_J = 25^\circ\text{C}$ )	$I_O$	–	700	–	mA

### MC78M12C/AC/B/AB, NCV78M12B ELECTRICAL CHARACTERISTICS

( $V_I = 19\text{ V}$ ,  $I_O = 350\text{ mA}$ ,  $T_J = T_{\text{low}}$  to  $T_{\text{high}}$ ,  $P_D \leq 5\text{ W}$ , unless otherwise noted) (Note 4)

Characteristics	Symbol	Min	Typ	Max	Unit
Output Voltage ( $T_J = 25^\circ\text{C}$ ) MC78M12B/MC78M12C/NCV78M12B MC78M12AB/MC78M12AC	$V_O$	11.50 11.76	12 12	12.50 12.24	Vdc
Output Voltage Variation ( $14.5\text{ Vdc} \leq V_I \leq 27\text{ Vdc}$ , $5.0\text{ mA} \leq I_O \leq 350\text{ mA}$ ) MC78M12B/MC78M12C/NCV78M12B MC78M12AB/MC78M12AC	$V_O$	11.4 11.5	– –	12.6 12.5	Vdc
Line Regulation ( $T_J = 25^\circ\text{C}$ , $14.5\text{ Vdc} \leq V_I \leq 30\text{ Vdc}$ , $I_O = 200\text{ mA}$ )	$\text{Reg}_{\text{line}}$	–	8.0	50	mV
Load Regulation ( $T_J = 25^\circ\text{C}$ , $5.0\text{ mA} \leq I_O \leq 500\text{ mA}$ ) ( $T_J = 25^\circ\text{C}$ , $5.0\text{ mA} \leq I_O \leq 200\text{ mA}$ )	$\text{Reg}_{\text{load}}$	–	25 10	240 120	mV
Input Bias Current ( $T_J = 25^\circ\text{C}$ )	$I_{\text{IB}}$	–	3.2	6.0	mA
Quiescent Current Change ( $14.5\text{ Vdc} \leq V_I \leq 30\text{ Vdc}$ , $I_O = 200\text{ mA}$ ) ( $5.0\text{ mA} \leq I_O \leq 350\text{ mA}$ )	$\Delta I_{\text{IB}}$	–	–	0.8 0.5	mA
Output Noise Voltage ( $T_A = 25^\circ\text{C}$ , $10\text{ Hz} \leq f \leq 100\text{ kHz}$ )	$V_n$	–	75	–	$\mu\text{V}$
Ripple Rejection ( $I_O = 100\text{ mA}$ , $f = 120\text{ Hz}$ , $15\text{ V} \leq V_I \leq 25\text{ V}$ ) ( $I_O = 300\text{ mA}$ , $f = 120\text{ Hz}$ , $15\text{ V} \leq V_I \leq 25\text{ V}$ , $T_J = 25^\circ\text{C}$ )	RR	55 55	– 80	– –	dB
Dropout Voltage ( $T_J = 25^\circ\text{C}$ )	$V_I - V_O$	–	2.0	–	Vdc
Short Circuit Current Limit ( $T_J = 25^\circ\text{C}$ , $V_I = 35\text{ V}$ )	$I_{\text{OS}}$	–	350	–	mA
Average Temperature Coefficient of Output Voltage ( $I_O = 5.0\text{ mA}$ )	$\Delta V_O / \Delta T$	–	$\pm 0.3$	–	$\text{mV}/^\circ\text{C}$
Peak Output Current ( $T_J = 25^\circ\text{C}$ )	$I_O$	–	700	–	mA

4.  $T_{\text{low}} = 0^\circ\text{C}$  for MC78MxxAC, C  
 =  $-40^\circ\text{C}$  for MC78MxxAB, B, NCV78MxxAB, B  
 $T_{\text{high}} = +125^\circ\text{C}$  for MC78MxxAB, AC, B, C, NCV78MxxAB, B

## MC78M00, MC78M00A, NCV78M00 Series

### MC78M15C/AC/B/AB, NCV78M15B ELECTRICAL CHARACTERISTICS

( $V_I = 23\text{ V}$ ,  $I_O = 350\text{ mA}$ ,  $T_J = T_{\text{low}}$  to  $T_{\text{high}}$ ,  $P_D \leq 5\text{ W}$ , unless otherwise noted) (Note 5)

Characteristics	Symbol	Min	Typ	Max	Unit
Output Voltage ( $T_J = 25^\circ\text{C}$ ) MC78M15B/MC78M15C/NCV78M15B MC78M15AB/MC78M15AC	$V_O$	14.4 14.7	15 15	15.6 15.3	Vdc
Output Voltage Variation ( $17.5\text{ Vdc} \leq V_I \leq 30\text{ Vdc}$ , $5.0\text{ mA} \leq I_O \leq 350\text{ mA}$ ) MC78M15B/MC78M15C/NCV78M15B MC78M15AB/MC78M15AC	$V_O$	14.25 14.40	– –	15.75 15.60	Vdc
Input Regulation ( $T_J = 25^\circ\text{C}$ , $17.5\text{ Vdc} \leq V_I \leq 30\text{ Vdc}$ , $I_O = 200\text{ mA}$ )	$\text{Reg}_{\text{line}}$	–	10	50	mV
Load Regulation ( $T_J = 25^\circ\text{C}$ , $5.0\text{ mA} \leq I_O \leq 500\text{ mA}$ ) ( $T_J = 25^\circ\text{C}$ , $5.0\text{ mA} \leq I_O \leq 200\text{ mA}$ )	$\text{Reg}_{\text{load}}$	– –	25 10	300 150	mV
Input Bias Current ( $T_J = 25^\circ\text{C}$ )	$I_{\text{IB}}$	–	3.2	6.0	mA
Quiescent Current Change ( $17.5\text{ Vdc} \leq V_I \leq 30\text{ Vdc}$ , $I_O = 200\text{ mA}$ ) ( $5.0\text{ mA} \leq I_O \leq 350\text{ mA}$ )	$\Delta I_{\text{IB}}$	– –	– –	0.8 0.5	mA
Output Noise Voltage ( $T_A = 25^\circ\text{C}$ , $10\text{ Hz} \leq f \leq 100\text{ kHz}$ )	$V_n$	–	90	–	$\mu\text{V}$
Ripple Rejection ( $I_O = 100\text{ mA}$ , $f = 120\text{ Hz}$ , $18.5\text{ V} \leq V_I \leq 28.5\text{ V}$ ) ( $I_O = 300\text{ mA}$ , $f = 120\text{ Hz}$ , $18.5\text{ V} \leq V_I \leq 28.5\text{ V}$ , $T_J = 25^\circ\text{C}$ )	RR	54 54	– 70	– –	dB
Dropout Voltage ( $T_J = 25^\circ\text{C}$ )	$V_I - V_O$	–	2.0	–	Vdc
Short Circuit Current Limit ( $T_J = 25^\circ\text{C}$ , $V_I = 35\text{ V}$ )	$I_{\text{OS}}$	–	350	–	mA
Average Temperature Coefficient of Output Voltage ( $I_O = 5.0\text{ mA}$ )	$\Delta V_O / \Delta T$	–	$\pm 0.3$	–	$\text{mV}/^\circ\text{C}$
Peak Output Current ( $T_J = 25^\circ\text{C}$ )	$I_O$	–	700	–	mA

### MC78M18C/B ELECTRICAL CHARACTERISTICS

( $V_I = 27\text{ V}$ ,  $I_O = 350\text{ mA}$ ,  $T_J = T_{\text{low}}$  to  $T_{\text{high}}$ ,  $P_D \leq 5\text{ W}$ , unless otherwise noted) (Note 5)

Characteristics	Symbol	Min	Typ	Max	Unit
Output Voltage ( $T_J = 25^\circ\text{C}$ )	$V_O$	17.3	18	18.7	Vdc
Output Voltage Variation ( $21\text{ Vdc} \leq V_I \leq 33\text{ Vdc}$ , $5.0\text{ mA} \leq I_O \leq 350\text{ mA}$ )	$V_O$	17.1	–	18.9	Vdc
Line Regulation ( $T_J = 25^\circ\text{C}$ , $21\text{ Vdc} \leq V_I \leq 33\text{ Vdc}$ , $I_O = 200\text{ mA}$ )	$\text{Reg}_{\text{line}}$	–	10	50	mV
Load Regulation ( $T_J = 25^\circ\text{C}$ , $5.0\text{ mA} \leq I_O \leq 500\text{ mA}$ ) ( $T_J = 25^\circ\text{C}$ , $5.0\text{ mA} \leq I_O \leq 200\text{ mA}$ )	$\text{Reg}_{\text{load}}$	– –	30 10	360 180	mV
Input Bias Current ( $T_J = 25^\circ\text{C}$ )	$I_{\text{IB}}$	–	3.2	6.5	mA
Quiescent Current Change ( $21\text{ Vdc} \leq V_I \leq 33\text{ Vdc}$ , $I_O = 200\text{ mA}$ ) ( $5.0\text{ mA} \leq I_O \leq 350\text{ mA}$ )	$\Delta I_{\text{IB}}$	– –	– –	0.8 0.5	mA
Output Noise Voltage ( $T_A = 25^\circ\text{C}$ , $10\text{ Hz} \leq f \leq 100\text{ kHz}$ )	$V_n$	–	100	–	$\mu\text{V}$
Ripple Rejection ( $I_O = 100\text{ mA}$ , $f = 120\text{ Hz}$ , $22\text{ V} \leq V_I \leq 32\text{ V}$ ) ( $I_O = 300\text{ mA}$ , $f = 120\text{ Hz}$ , $22\text{ V} \leq V_I \leq 32\text{ V}$ , $T_J = 25^\circ\text{C}$ )	RR	53 53	– 70	– –	dB
Dropout Voltage ( $T_J = 25^\circ\text{C}$ )	$V_I - V_O$	–	2.0	–	Vdc
Short Circuit Current Limit ( $T_J = 25^\circ\text{C}$ , $V_I = 35\text{ V}$ )	$I_{\text{OS}}$	–	350	–	mA
Average Temperature Coefficient of Output Voltage ( $I_O = 5.0\text{ mA}$ )	$\Delta V_O / \Delta T$	–	$\pm 0.3$	–	$\text{mV}/^\circ\text{C}$
Peak Output Current ( $T_J = 25^\circ\text{C}$ )	$I_O$	–	700	–	mA

5.  $T_{\text{low}} = 0^\circ\text{C}$  for MC78MxxAC, C  
 =  $-40^\circ\text{C}$  for MC78MxxAB, B, NCV78MxxAB, B  
 $T_{\text{high}} = +125^\circ\text{C}$  for MC78MxxAB, AC, B, C, NCV78MxxAB, B

## MC78M00, MC78M00A, NCV78M00 Series

### MC78M20C/B ELECTRICAL CHARACTERISTICS

( $V_I = 29\text{ V}$ ,  $I_O = 350\text{ mA}$ ,  $T_J = T_{\text{low}}$  to  $T_{\text{high}}$ ,  $P_D \leq 5.0\text{ W}$ , unless otherwise noted) (Note 6)

Characteristics	Symbol	Min	Typ	Max	Unit
Output Voltage ( $T_J = 25^\circ\text{C}$ )	$V_O$	19.2	20	20.8	Vdc
Output Voltage Variation ( $23\text{ Vdc} \leq V_I \leq 35\text{ Vdc}$ , $5.0\text{ mA} \leq I_O \leq 350\text{ mA}$ )	$V_O$	19	–	21	Vdc
Line Regulation ( $T_J = 25^\circ\text{C}$ , $23\text{ Vdc} \leq V_I \leq 35\text{ Vdc}$ , $I_O = 200\text{ mA}$ )	$\text{Reg}_{\text{line}}$	–	10	50	mV
Load Regulation ( $T_J = 25^\circ\text{C}$ , $5.0\text{ mA} \leq I_O \leq 500\text{ mA}$ ) ( $T_J = 25^\circ\text{C}$ , $5.0\text{ mA} \leq I_O \leq 200\text{ mA}$ )	$\text{Reg}_{\text{load}}$	–	30 10	400 200	mV
Input Bias Current ( $T_J = 25^\circ\text{C}$ )	$I_{\text{IB}}$	–	3.2	6.5	mA
Quiescent Current Change ( $23\text{ Vdc} \leq V_I \leq 35\text{ Vdc}$ , $I_O = 200\text{ mA}$ ) ( $5.0\text{ mA} \leq I_O \leq 350\text{ mA}$ )	$\Delta I_{\text{IB}}$	–	–	0.8 0.5	mA
Output Noise Voltage ( $T_A = 25^\circ\text{C}$ , $10\text{ Hz} \leq f \leq 100\text{ kHz}$ )	$V_n$	–	110	–	$\mu\text{V}$
Ripple Rejection ( $I_O = 100\text{ mA}$ , $f = 120\text{ Hz}$ , $24\text{ V} \leq V_I \leq 34\text{ V}$ ) ( $I_O = 300\text{ mA}$ , $f = 120\text{ Hz}$ , $24\text{ V} \leq V_I \leq 34\text{ V}$ , $T_J = 25^\circ\text{C}$ )	RR	52 52	– 70	– –	dB
Dropout Voltage ( $T_J = 25^\circ\text{C}$ )	$V_I - V_O$	–	2.0	–	Vdc
Short Circuit Current Limit ( $T_J = 25^\circ\text{C}$ , $V_I = 35\text{ V}$ )	$I_{\text{OS}}$	–	350	–	mA
Average Temperature Coefficient of Output Voltage ( $I_O = 5.0\text{ mA}$ )	$\Delta V_O / \Delta T$	–	$\pm 0.5$	–	$\text{mV}/^\circ\text{C}$
Peak Output Current ( $T_J = 25^\circ\text{C}$ )	$I_O$	–	700	–	mA

### MC78M24C/B ELECTRICAL CHARACTERISTICS

( $V_I = 33\text{ V}$ ,  $I_O = 350\text{ mA}$ ,  $T_J = T_{\text{low}}$  to  $T_{\text{high}}$ ,  $P_D \leq 5.0\text{ W}$ , unless otherwise noted) (Note 6)

Characteristics	Symbol	Min	Typ	Max	Unit
Output Voltage ( $T_J = 25^\circ\text{C}$ )	$V_O$	23	24	25	Vdc
Output Voltage Variation ( $27\text{ Vdc} \leq V_I \leq 38\text{ Vdc}$ , $5.0\text{ mA} \leq I_O \leq 350\text{ mA}$ )	$V_O$	22.8	–	25.2	Vdc
Line Regulation ( $T_J = 25^\circ\text{C}$ , $27\text{ Vdc} \leq V_I \leq 38\text{ Vdc}$ , $I_O = 200\text{ mA}$ )	$\text{Reg}_{\text{line}}$	–	10	50	mV
Load Regulation ( $T_J = 25^\circ\text{C}$ , $5.0\text{ mA} \leq I_O \leq 500\text{ mA}$ ) ( $T_J = 25^\circ\text{C}$ , $5.0\text{ mA} \leq I_O \leq 200\text{ mA}$ )	$\text{Reg}_{\text{load}}$	–	30 10	480 240	mV
Input Bias Current ( $T_J = 25^\circ\text{C}$ )	$I_{\text{IB}}$	–	3.2	7.0	mA
Quiescent Current Change ( $27\text{ Vdc} \leq V_I \leq 38\text{ Vdc}$ , $I_O = 200\text{ mA}$ ) ( $5.0\text{ mA} \leq I_O \leq 350\text{ mA}$ )	$\Delta I_{\text{IB}}$	–	–	0.8 0.5	mA
Output Noise Voltage ( $T_A = 25^\circ\text{C}$ , $10\text{ Hz} \leq f \leq 100\text{ kHz}$ )	$V_n$	–	170	–	$\mu\text{V}$
Ripple Rejection ( $I_O = 100\text{ mA}$ , $f = 120\text{ Hz}$ , $28\text{ V} \leq V_I \leq 38\text{ V}$ ) ( $I_O = 300\text{ mA}$ , $f = 120\text{ Hz}$ , $28\text{ V} \leq V_I \leq 38\text{ V}$ , $T_J = 25^\circ\text{C}$ )	RR	50 50	– 70	– –	dB
Dropout Voltage ( $T_J = 25^\circ\text{C}$ )	$V_I - V_O$	–	2.0	–	Vdc
Short Circuit Current Limit ( $T_J = 25^\circ\text{C}$ )	$I_{\text{OS}}$	–	350	–	mA
Average Temperature Coefficient of Output Voltage ( $I_O = 5.0\text{ mA}$ )	$\Delta V_O / \Delta T$	–	$\pm 0.5$	–	$\text{mV}/^\circ\text{C}$
Peak Output Current ( $T_J = 25^\circ\text{C}$ )	$I_O$	–	700	–	mA

6.  $T_{\text{low}} = 0^\circ\text{C}$  for MC78MxxAC, C  
 =  $-40^\circ\text{C}$  for MC78MxxAB, B  
 $T_{\text{high}} = +125^\circ\text{C}$  for MC78MxxAB, AC, B, C

DEFINITIONS

**Line Regulation** – The change in output voltage for a change in the input voltage. The measurement is made under conditions of low dissipation or by using pulse techniques such that the average chip temperature is not significantly affected.

**Load Regulation** – The change in output voltage for a change in load current at constant chip temperature.

**Maximum Power Dissipation** – The maximum total device dissipation for which the regulator will operate within specifications.

**Input Bias Current** – That part of the input current that is not delivered to the load.

**Output Noise Voltage** – The rms AC voltage at the output, with constant load and no input ripple, measured over a specified frequency range.

**Long Term Stability** – Output voltage stability under accelerated life test conditions with the maximum rated voltage listed in the devices' electrical characteristics and maximum power dissipation.

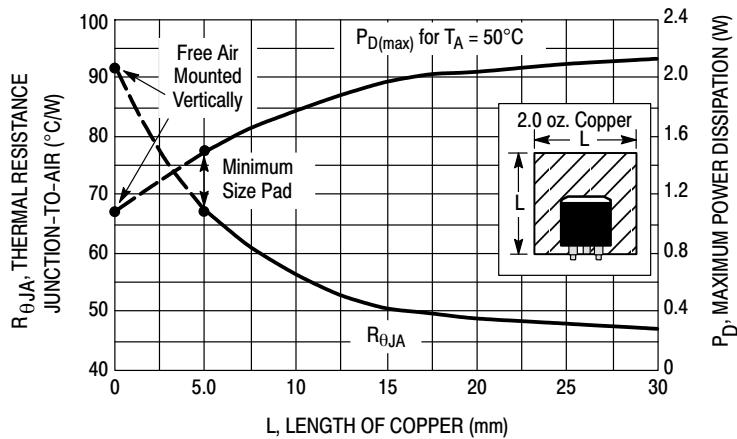

Figure 2. DPAK Thermal Resistance and Maximum Power Dissipation versus P.C.B. Copper Length

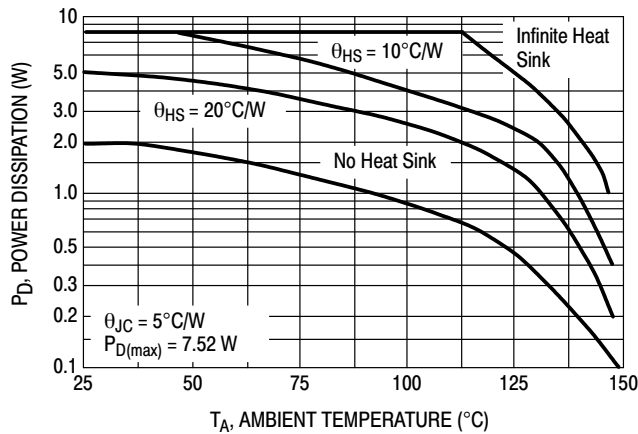
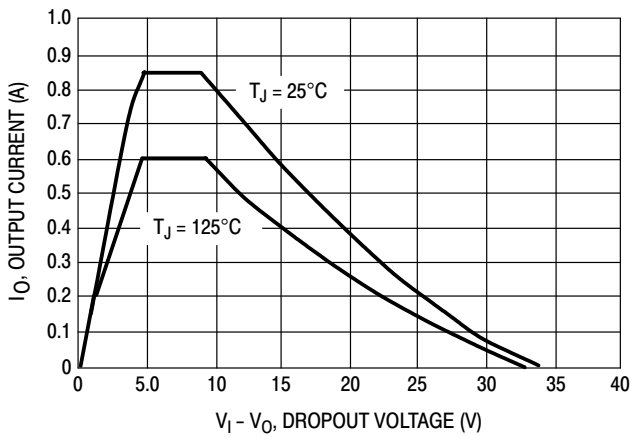
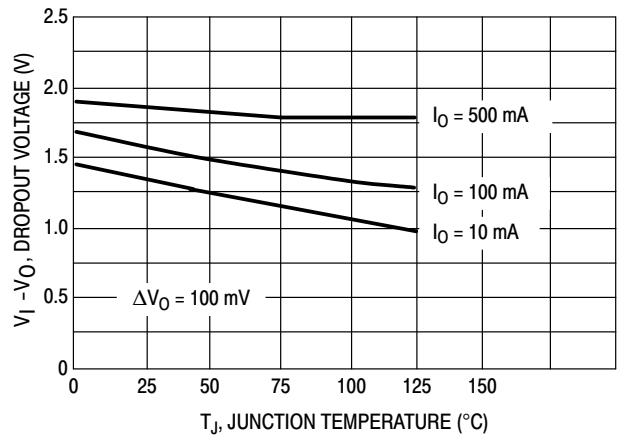

Figure 3. Worst Case Power Dissipation versus Ambient Temperature (TO-220)

# MC78M00, MC78M00A, NCV78M00 Series



**Figure 4. Peak Output Current versus Dropout Voltage**



**Figure 5. Dropout Voltage versus Junction Temperature**

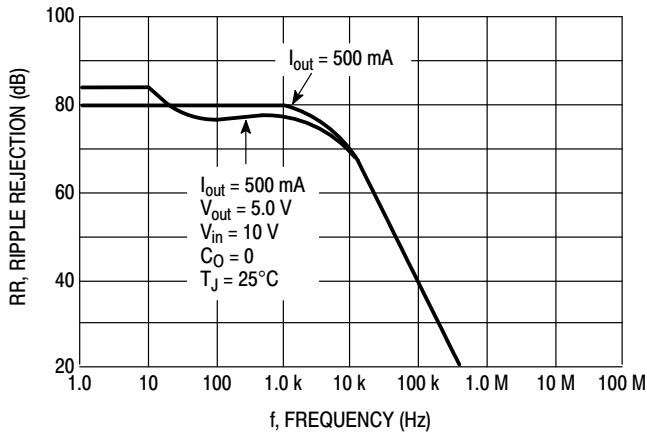

**Figure 6. Ripple Rejection versus Frequency**

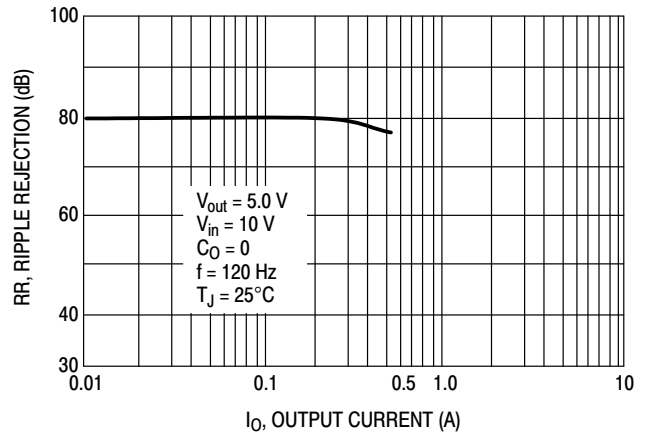

**Figure 7. Ripple Rejection versus Output Current**

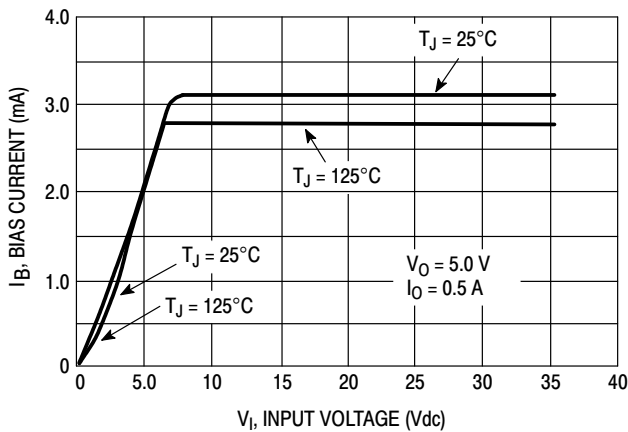

**Figure 8. Bias Current versus Input Voltage**

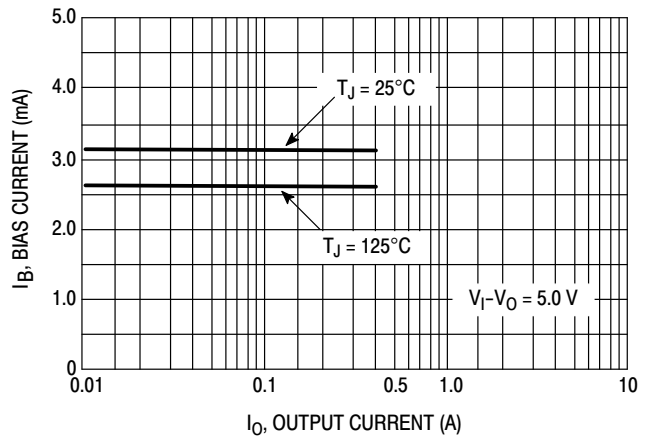

**Figure 9. Bias Current versus Output Current**



APPLICATIONS INFORMATION

Design Considerations

The MC78M00/MC78M00A Series of fixed voltage regulators are designed with Thermal Overload Protection that shuts down the circuit when subjected to an excessive power overload condition, Internal Short Circuit Protection that limits the maximum current the circuit will pass, and Output Transistor Safe-Area Compensation that reduces the output short circuit current as the voltage across the pass transistor is increased.

In many low current applications, compensation capacitors are not required. However, it is recommended that the regulator input be bypassed with a capacitor if the

regulator is connected to the power supply filter with long wire lengths, or if the output load capacitance is large. An input bypass capacitor should be selected to provide good high frequency characteristics to insure stable operation under all load conditions. A 0.33 μF or larger tantalum, mylar, or other capacitor having low internal impedance at high frequencies should be chosen. The bypass capacitor should be mounted with the shortest possible leads directly across the regulator's input terminals. Normally good construction techniques should be used to minimize ground loops and lead resistance drops since the regulator has no external sense lead.

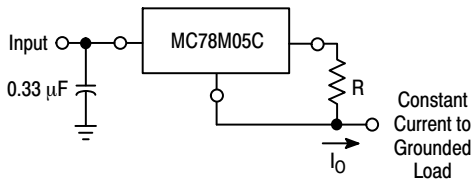

The MC78M00 regulators can also be used as a current source when connected as above. In order to minimize dissipation the MC78M05C is chosen in this application. Resistor R determines the current as follows:

$$I_o = \frac{5.0 V}{R} + I_{IB}$$

$I_{IB} = 1.5 \text{ mA}$  over line and load changes.

For example, a 500 mA current source would require R to be a 10 Ω, 10 W resistor and the output voltage compliance would be the input voltage less 7.0 V.

Figure 10. Current Regulator

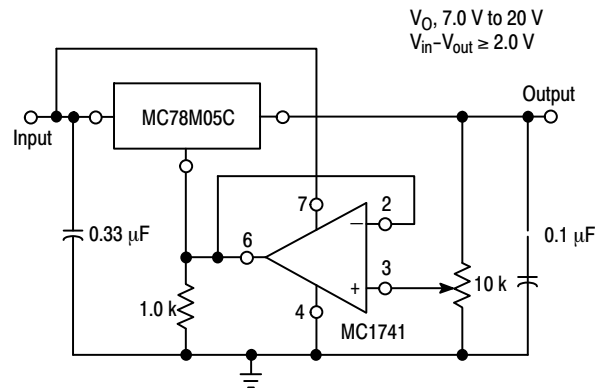

The addition of an operational amplifier allows adjustment to higher or intermediate values while retaining regulation characteristics. The minimum voltage obtainable with this arrangement is 2.0 V greater than the regulator voltage.

Figure 11. Adjustable Output Regulator

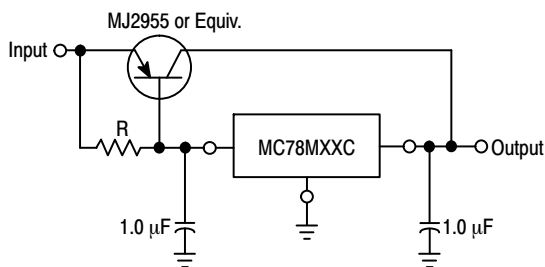

XX = 2 digits of type number indicating voltage.

The MC78M00 series can be current boosted with a PNP transistor. The MJ2955 provides current to 5.0 A. Resistor R in conjunction with the  $V_{BE}$  of the PNP determines when the pass transistor begins conducting; this circuit is not short circuit proof. Input-output differential voltage minimum is increased by  $V_{BE}$  of the pass transistor.

Figure 12. Current Boost Regulator

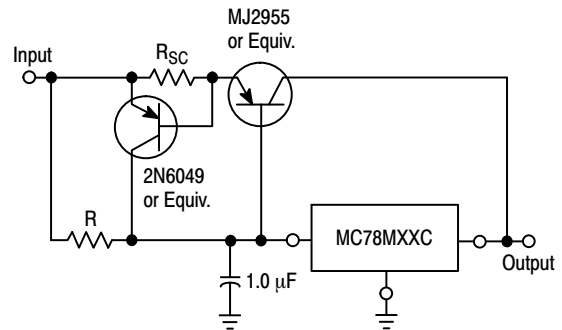

XX = 2 digits of type number indicating voltage.

The circuit of Figure 12 can be modified to provide supply protection against short circuits by adding a short circuit sense resistor,  $R_{sc}$ , and an additional PNP transistor. The current sensing PNP must be able to handle the short circuit current of the three-terminal regulator. Therefore, a 4.0 A plastic power transistor is specified.

Figure 13. Current Boost with Short Circuit Protection

## MC78M00, MC78M00A, NCV78M00 Series

### ORDERING INFORMATION

Device	Output Voltage	Temperature Range	Package	Marking	Shipping <sup>†</sup>
MC78M05CDTG	5.0 V	T <sub>J</sub> = 0° to +125°C	DPAK-3 (Pb-Free)	78M05	75 Units / Rail
MC78M05CDTT5G	5.0 V	T <sub>J</sub> = 0° to +125°C	DPAK-3 (Pb-Free)	78M05	2500 / Tape & Reel
MC78M05CDTRKG	5.0 V	T <sub>J</sub> = 0° to +125°C	DPAK-3 (Pb-Free)	78M05	2500 / Tape & Reel
MC78M05ACDTG	5.0 V	T <sub>J</sub> = 0° to +125°C	DPAK-3 (Pb-Free)	8M05D	75 Units / Rail
MC78M05ACDTRKG	5.0 V	T <sub>J</sub> = 0° to +125°C	DPAK-3 (Pb-Free)	8M05D	2500 / Tape & Reel
MC78M05CTG	5.0 V	T <sub>J</sub> = 0° to +125°C	TO-220 (Pb-Free)	78M05CT	50 Units / Rail
MC78M05ACTG	5.0 V	T <sub>J</sub> = 0° to +125°C	TO-220 (Pb-Free)	78M05ACT	50 Units / Rail
MC78M05ABDTG	5.0 V	T <sub>J</sub> = -40° to +125°C	DPAK-3 (Pb-Free)	8M05A	75 Units / Rail
MC78M05ABDTRKG	5.0 V	T <sub>J</sub> = -40° to +125°C	DPAK-3 (Pb-Free)	8M05A	2500 / Tape & Reel
NCV78M05ABDTRKG*	5.0 V	T <sub>J</sub> = -40° to +125°C	DPAK-3 (Pb-Free)	8M05A	2500 / Tape & Reel
MC78M05ABTG	5.0 V	T <sub>J</sub> = -40° to +125°C	TO-220 (Pb-Free)	78M05ABT	50 Units / Rail
MC78M05BDTG	5.0 V	T <sub>J</sub> = -40° to +125°C	DPAK-3 (Pb-Free)	8M05B	75 Units / Rail
MC78M05BDTT5G	5.0 V	T <sub>J</sub> = -40° to +125°C	DPAK-3 (Pb-Free)	8M05B	2500 / Tape & Reel
MC78M05BDTRKG	5.0 V	T <sub>J</sub> = -40° to +125°C	DPAK-3 (Pb-Free)	8M05B	2500 / Tape & Reel
NCV78M05BDTRKG*	5.0 V	T <sub>J</sub> = -40° to +125°C	DPAK-3 (Pb-Free)	8M05B	2500 / Tape & Reel
MC78M05BTG	5.0 V	T <sub>J</sub> = -40° to +125°C	TO-220 (Pb-Free)	78M05BT	50 Units / Rail
NCV78M05BTG*	5.0 V	T <sub>J</sub> = -40° to +125°C	TO-220 (Pb-Free)	78M05BT	50 Units / Rail
MC78M06CDTG	6.0 V	T <sub>J</sub> = 0° to +125°C	DPAK-3 (Pb-Free)	78M06	75 Units / Rail
MC78M06CDTRKG	6.0 V	T <sub>J</sub> = 0° to +125°C	DPAK-3 (Pb-Free)	78M06	2500 / Tape & Reel
MC78M06CTG	6.0 V	T <sub>J</sub> = 0° to +125°C	TO-220 (Pb-Free)	78M06CT	50 Units / Rail
MC78M06BTG	6.0 V	T <sub>J</sub> = -40° to +125°C	TO-220 (Pb-Free)	78M06BT	50 Units / Rail
MC78M06BDTRKG	6.0 V	T <sub>J</sub> = -40° to +125°C	DPAK-3 (Pb-Free)	8M06B	2500 / Tape & Reel
MC78M08CDTG	8.0 V	T <sub>J</sub> = 0° to +125°C	DPAK-3 (Pb-Free)	78M08	75 Units / Rail

<sup>†</sup>For information on tape and reel specifications, including part orientation and tape sizes, please refer to our Tape and Reel Packaging Specifications Brochure, BRD8011/D.

\*NCV devices: T<sub>low</sub> = -40°C, T<sub>high</sub> = +125°C. Guaranteed by design. NCV Prefix for Automotive and Other Applications Requiring Unique Site and Control Change Requirements; AEC-Q100 Qualified and PPAP Capable.

## MC78M00, MC78M00A, NCV78M00 Series

### ORDERING INFORMATION (continued)

Device	Output Voltage	Temperature Range	Package	Marking	Shipping <sup>†</sup>
MC78M08CDTRKG	8.0 V	T <sub>J</sub> = 0° to +125°C	DPAK-3 (Pb-Free)	78M08	2500 Units / Tape & Reel
MC78M08ACDTG	8.0 V	T <sub>J</sub> = 0° to +125°C	DPAK-3 (Pb-Free)	8M08D	75 Units / Rail
MC78M08ACDTRKG	8.0 V	T <sub>J</sub> = 0° to +125°C	DPAK-3 (Pb-Free)	8M08D	2500 Units / Tape & Reel
MC78M08CTG	8.0 V	T <sub>J</sub> = 0° to +125°C	TO-220 (Pb-Free)	78M08CT	50 Units / Rail
MC78M08ACTG	8.0 V	T <sub>J</sub> = 0° to +125°C	TO-220 (Pb-Free)	78M08ACT	50 Units / Rail
MC78M08ABDTG	8.0 V	T <sub>J</sub> = -40° to +125°C	DPAK-3 (Pb-Free)	8M08A	75 Units / Rail
MC78M08ABDTRKG	8.0 V	T <sub>J</sub> = -40° to +125°C	DPAK-3 (Pb-Free)	8M08A	2500 Units / Tape & Reel
MC78M08ABTG	8.0 V	T <sub>J</sub> = -40° to +125°C	TO-220 (Pb-Free)	78M08ABT	50 Units / Rail
MC78M08BDTG	8.0 V	T <sub>J</sub> = -40° to +125°C	DPAK-3 (Pb-Free)	8M08B	75 Units / Rail
MC78M08BDTRKG	8.0 V	T <sub>J</sub> = -40° to +125°C	DPAK-3 (Pb-Free)	8M08B	2500 Units / Tape & Reel
NCV78M08BDTRKG*	8.0 V	T <sub>J</sub> = -40° to +125°C	DPAK-3 (Pb-Free)	8M08B	2500 Units / Tape & Reel
MC78M08BTG	8.0 V	T <sub>J</sub> = -40° to +125°C	TO-220 (Pb-Free)	78M08BT	50 Units / Rail
MC78M09CDTG	9.0 V	T <sub>J</sub> = 0° to +125°C	DPAK-3 (Pb-Free)	78M09	75 Units / Rail
MC78M09CDTRKG	9.0 V	T <sub>J</sub> = 0° to +125°C	DPAK-3 (Pb-Free)	78M09	2500 Units / Tape & Reel
MC78M09CTG	9.0 V	T <sub>J</sub> = 0° to +125°C	TO-220 (Pb-Free)	78M09CT	50 Units / Rail
MC78M09BDTG	9.0 V	T <sub>J</sub> = -40° to +125°C	DPAK-3 (Pb-Free)	8M09B	75 Units / Rail
MC78M09BDTRKG	9.0 V	T <sub>J</sub> = -40° to +125°C	DPAK-3 (Pb-Free)	8M09B	2500 Units / Tape & Reel
MC78M12CDTG	12 V	T <sub>J</sub> = 0° to +125°C	DPAK-3 (Pb-Free)	78M12	75 Units / Rail
MC78M12CDTT5G	12 V	T <sub>J</sub> = 0° to +125°C	DPAK-3 (Pb-Free)	78M12	2500 Units / Tape & Reel
MC78M12CDTRKG	12 V	T <sub>J</sub> = 0° to +125°C	DPAK-3 (Pb-Free)	78M12	2500 Units / Tape & Reel
MC78M12ACDTG	12 V	T <sub>J</sub> = 0° to +125°C	DPAK-3 (Pb-Free)	8M12D	75 Units / Rail
MC78M12ACDTRKG	12 V	T <sub>J</sub> = 0° to +125°C	DPAK-3 (Pb-Free)	8M12D	2500 Units / Tape & Reel
MC78M12CTG	12 V	T <sub>J</sub> = 0° to +125°C	TO-220 (Pb-Free)	78M12CT	50 Units / Rail

<sup>†</sup>For information on tape and reel specifications, including part orientation and tape sizes, please refer to our Tape and Reel Packaging Specifications Brochure, BRD8011/D.

\*NCV devices: T<sub>low</sub> = -40°C, T<sub>high</sub> = +125°C. Guaranteed by design. NCV Prefix for Automotive and Other Applications Requiring Unique Site and Control Change Requirements; AEC-Q100 Qualified and PPAP Capable.

## MC78M00, MC78M00A, NCV78M00 Series

### ORDERING INFORMATION (continued)

Device	Output Voltage	Temperature Range	Package	Marking	Shipping <sup>†</sup>
MC78M12ACTG	12 V	$T_J = 0^\circ \text{ to } +125^\circ\text{C}$	TO-220 (Pb-Free)	78M12ACT	50 Units / Rail
MC78M12ABDTG	12 V	$T_J = -40^\circ \text{ to } +125^\circ\text{C}$	DPAK-3 (Pb-Free)	8M12A	75 Units / Rail
MC78M12ABDTRKG	12 V	$T_J = -40^\circ \text{ to } +125^\circ\text{C}$	DPAK-3 (Pb-Free)	8M12A	2500 Units / Tape & Reel
MC78M12ABTG	12 V	$T_J = -40^\circ \text{ to } +125^\circ\text{C}$	TO-220 (Pb-Free)	78M12ABT	50 Units / Rail
MC78M12BDTG	12 V	$T_J = -40^\circ \text{ to } +125^\circ\text{C}$	DPAK-3 (Pb-Free)	8M12B	75 Units / Rail
MC78M12BDTRKG	12 V	$T_J = -40^\circ \text{ to } +125^\circ\text{C}$	DPAK-3 (Pb-Free)	8M12B	2500 Units / Tape & Reel
NCV78M12BDTRKG*	12 V	$T_J = -40^\circ \text{ to } +125^\circ\text{C}$	DPAK-3 (Pb-Free)	8M12B	2500 Units / Tape & Reel
MC78M12BTG	12 V	$T_J = -40^\circ \text{ to } +125^\circ\text{C}$	TO-220 (Pb-Free)	78M12BT	50 Units / Rail
MC78M15CDTG	15 V	$T_J = 0^\circ \text{ to } +125^\circ\text{C}$	DPAK-3 (Pb-Free)	78M15	75 Units / Rail
MC78M15CDTT5G	15 V	$T_J = 0^\circ \text{ to } +125^\circ\text{C}$	DPAK-3 (Pb-Free)	78M15	2500 Units / Tape & Reel
MC78M15CDTRKG	15 V	$T_J = 0^\circ \text{ to } +125^\circ\text{C}$	DPAK-3 (Pb-Free)	78M15	2500 Units / Tape & Reel
MC78M15ACDTG	15 V	$T_J = 0^\circ \text{ to } +125^\circ\text{C}$	DPAK-3 (Pb-Free)	8M15D	75 Units / Rail
MC78M15ACDTRKG	15 V	$T_J = 0^\circ \text{ to } +125^\circ\text{C}$	DPAK-3 (Pb-Free)	8M15D	2500 Units / Tape & Reel
MC78M15CTG	15 V	$T_J = 0^\circ \text{ to } +125^\circ\text{C}$	TO-220 (Pb-Free)	78M15CT	50 Units / Rail
MC78M15ACTG	15 V	$T_J = 0^\circ \text{ to } +125^\circ\text{C}$	TO-220 (Pb-Free)	78M15ACT	50 Units / Rail
MC78M15ABDTG	15 V	$T_J = -40^\circ \text{ to } +125^\circ\text{C}$	DPAK-3 (Pb-Free)	8M15A	75 Units / Rail
MC78M15ABDTRKG	15 V	$T_J = -40^\circ \text{ to } +125^\circ\text{C}$	DPAK-3 (Pb-Free)	8M15A	2500 Units / Tape & Reel
MC78M15ABTG	15 V	$T_J = -40^\circ \text{ to } +125^\circ\text{C}$	TO-220 (Pb-Free)	78M15ABT	50 Units / Rail
MC78M15BDTG	15 V	$T_J = -40^\circ \text{ to } +125^\circ\text{C}$	DPAK-3 (Pb-Free)	8M15B	75 Units / Rail
NCV78M15BDTG*	15 V	$T_J = -40^\circ \text{ to } +125^\circ\text{C}$	DPAK-3 (Pb-Free)	8M15B	75 Units / Rail
MC78M15BDTRKG	15 V	$T_J = -40^\circ \text{ to } +125^\circ\text{C}$	DPAK-3 (Pb-Free)	8M15B	2500 Units / Tape & Reel
MC78M15BTG	15 V	$T_J = -40^\circ \text{ to } +125^\circ\text{C}$	TO-220 (Pb-Free)	78M15BT	50 Units / Rail
MC78M18CDTG	18 V	$T_J = 0^\circ \text{ to } +125^\circ\text{C}$	DPAK-3 (Pb-Free)	78M18	75 Units / Rail

<sup>†</sup>For information on tape and reel specifications, including part orientation and tape sizes, please refer to our Tape and Reel Packaging Specifications Brochure, BRD8011/D.

\*NCV devices:  $T_{low} = -40^\circ\text{C}$ ,  $T_{high} = +125^\circ\text{C}$ . Guaranteed by design. NCV Prefix for Automotive and Other Applications Requiring Unique Site and Control Change Requirements; AEC-Q100 Qualified and PPAP Capable.

## MC78M00, MC78M00A, NCV78M00 Series

### ORDERING INFORMATION (continued)

Device	Output Voltage	Temperature Range	Package	Marking	Shipping <sup>†</sup>
MC78M18CDTRKG	18 V	$T_J = 0^\circ$ to $+125^\circ\text{C}$	DPAK-3 (Pb-Free)	78M18	2500 Units / Tape & Reel
MC78M18CTG	18 V	$T_J = 0^\circ$ to $+125^\circ\text{C}$	TO-220 (Pb-Free)	78M18CT	50 Units / Rail
MC78M18BTG	18 V	$T_J = -40^\circ$ to $+125^\circ\text{C}$	TO-220 (Pb-Free)	78M18BT	50 Units / Rail
MC78M20CTG	20 V	$T_J = 0^\circ$ to $+125^\circ\text{C}$	TO-220 (Pb-Free)	78M20CT	50 Units / Rail
MC78M24CTG	24 V	$T_J = 0^\circ$ to $+125^\circ\text{C}$	TO-220 (Pb-Free)	78M24CT	50 Units / Rail
MC78M24BTG	24 V	$T_J = -40^\circ$ to $+125^\circ\text{C}$	TO-220 (Pb-Free)	78M24BT	50 Units / Rail

<sup>†</sup>For information on tape and reel specifications, including part orientation and tape sizes, please refer to our Tape and Reel Packaging Specifications Brochure, BRD8011/D.

\*NCV devices:  $T_{\text{low}} = -40^\circ\text{C}$ ,  $T_{\text{high}} = +125^\circ\text{C}$ . Guaranteed by design. NCV Prefix for Automotive and Other Applications Requiring Unique Site and Control Change Requirements; AEC-Q100 Qualified and PPAP Capable.

# MC78M00, MC78M00A, NCV78M00 Series

## PACKAGE DIMENSIONS

DPAK-3  
DT SUFFIX  
CASE 369C  
ISSUE D

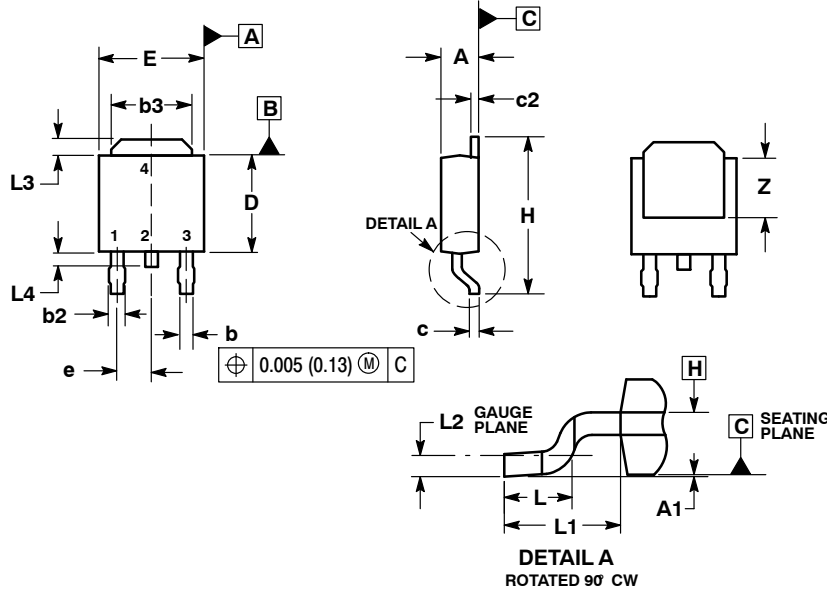

NOTES:

1. DIMENSIONING AND TOLERANCING PER ASME Y14.5M, 1994.
2. CONTROLLING DIMENSION: INCHES.
3. THERMAL PAD CONTOUR OPTIONAL WITHIN DIMENSIONS b3, L3 and Z.
4. DIMENSIONS D AND E DO NOT INCLUDE MOLD FLASH, PROTRUSIONS, OR BURRS. MOLD FLASH, PROTRUSIONS, OR GATE BURRS SHALL NOT EXCEED 0.006 INCHES PER SIDE.
5. DIMENSIONS D AND E ARE DETERMINED AT THE OUTERMOST EXTREMES OF THE PLASTIC BODY.
6. DATUMS A AND B ARE DETERMINED AT DATUM PLANE H.

DIM	INCHES		MILLIMETERS	
	MIN	MAX	MIN	MAX
A	0.086	0.094	2.18	2.38
A1	0.000	0.005	0.00	0.13
b	0.025	0.035	0.63	0.89
b2	0.030	0.045	0.76	1.14
b3	0.180	0.215	4.57	5.46
c	0.018	0.024	0.46	0.61
c2	0.018	0.024	0.46	0.61
D	0.235	0.245	5.97	6.22
E	0.250	0.265	6.35	6.73
e	0.090 BSC		2.29 BSC	
H	0.370	0.410	9.40	10.41
L	0.055	0.070	1.40	1.78
L1	0.108 REF		2.74 REF	
L2	0.020 BSC		0.51 BSC	
L3	0.035	0.050	0.89	1.27
L4	---	0.040	---	1.01
Z	0.155	---	3.93	---

### SOLDERING FOOTPRINT\*

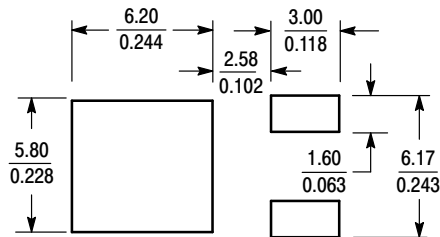

SCALE 3:1  $\left(\frac{\text{mm}}{\text{inches}}\right)$

\*For additional information on our Pb-Free strategy and soldering details, please download the ON Semiconductor Soldering and Mounting Techniques Reference Manual, SOLDERRM/D.

# MC78M00, MC78M00A, NCV78M00 Series

## PACKAGE DIMENSIONS

### TO-220, SINGLE GAUGE CASE 221AB ISSUE A

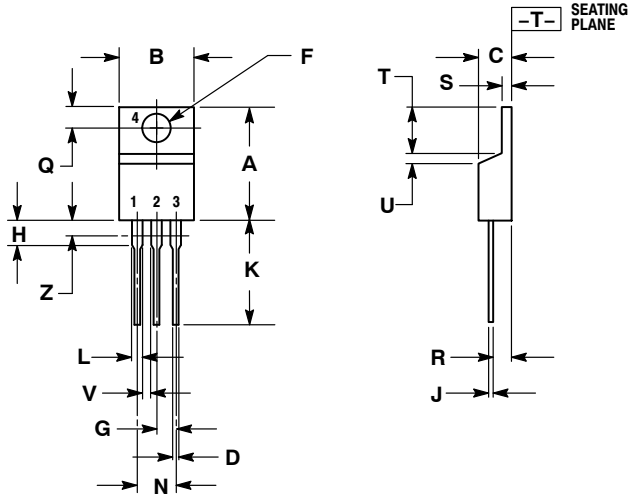

#### NOTES:

1. DIMENSIONING AND TOLERANCING PER ANSI Y14.5M, 1982.
2. CONTROLLING DIMENSION: INCHES.
3. DIMENSION Z DEFINES A ZONE WHERE ALL BODY AND LEAD IRREGULARITIES ARE ALLOWED.
4. PRODUCT SHIPPED PRIOR TO 2008 HAD DIMENSIONS S = 0.045 - 0.055 INCHES (1.143 - 1.397 MM)

DIM	INCHES		MILLIMETERS	
	MIN	MAX	MIN	MAX
A	0.570	0.620	14.48	15.75
B	0.380	0.405	9.66	10.28
C	0.160	0.190	4.07	4.82
D	0.025	0.035	0.64	0.88
F	0.142	0.147	3.61	3.73
G	0.095	0.105	2.42	2.66
H	0.110	0.155	2.80	3.93
J	0.018	0.025	0.46	0.64
K	0.500	0.562	12.70	14.27
L	0.045	0.060	1.15	1.52
N	0.190	0.210	4.83	5.33
Q	0.100	0.120	2.54	3.04
R	0.080	0.110	2.04	2.79
S	0.020	0.024	0.508	0.61
T	0.235	0.255	5.97	6.47
U	0.000	0.050	0.00	1.27
V	0.045	---	1.15	---
Z	---	0.080	---	2.04

ON Semiconductor and  are registered trademarks of Semiconductor Components Industries, LLC (SCILLC). SCILLC owns the rights to a number of patents, trademarks, copyrights, trade secrets, and other intellectual property. A listing of SCILLC's product/patent coverage may be accessed at [www.onsemi.com/site/pdf/Patent-Marking.pdf](http://www.onsemi.com/site/pdf/Patent-Marking.pdf). SCILLC reserves the right to make changes without further notice to any products herein. SCILLC makes no warranty, representation or guarantee regarding the suitability of its products for any particular purpose, nor does SCILLC assume any liability arising out of the application or use of any product or circuit, and specifically disclaims any and all liability, including without limitation special, consequential or incidental damages. "Typical" parameters which may be provided in SCILLC data sheets and/or specifications can and do vary in different applications and actual performance may vary over time. All operating parameters, including "Typicals" must be validated for each customer application by customer's technical experts. SCILLC does not convey any license under its patent rights nor the rights of others. SCILLC products are not designed, intended, or authorized for use as components in systems intended for surgical implant into the body, or other applications intended to support or sustain life, or for any other application in which the failure of the SCILLC product could create a situation where personal injury or death may occur. Should Buyer purchase or use SCILLC products for any such unintended or unauthorized application, Buyer shall indemnify and hold SCILLC and its officers, employees, subsidiaries, affiliates, and distributors harmless against all claims, costs, damages, and expenses, and reasonable attorney fees arising out of, directly or indirectly, any claim of personal injury or death associated with such unintended or unauthorized use, even if such claim alleges that SCILLC was negligent regarding the design or manufacture of the part. SCILLC is an Equal Opportunity/Affirmative Action Employer. This literature is subject to all applicable copyright laws and is not for resale in any manner.

#### PUBLICATION ORDERING INFORMATION

##### LITERATURE FULFILLMENT:

Literature Distribution Center for ON Semiconductor  
P.O. Box 5163, Denver, Colorado 80217 USA  
Phone: 303-675-2175 or 800-344-3860 Toll Free USA/Canada  
Fax: 303-675-2176 or 800-344-3867 Toll Free USA/Canada  
Email: [orderlit@onsemi.com](mailto:orderlit@onsemi.com)

N. American Technical Support: 800-282-9855 Toll Free  
USA/Canada  
Europe, Middle East and Africa Technical Support:  
Phone: 421 33 790 2910  
Japan Customer Focus Center  
Phone: 81-3-5817-1050

ON Semiconductor Website: [www.onsemi.com](http://www.onsemi.com)

Order Literature: <http://www.onsemi.com/orderlit>

For additional information, please contact your local Sales Representative

# Mouser Electronics

Authorized Distributor

Click to View Pricing, Inventory, Delivery & Lifecycle Information:

## ON Semiconductor:

[MC78M05ABDT](#) [MC78M05ABDTG](#) [MC78M05ABDTRK](#) [MC78M05ABDTRKG](#) [MC78M05ABT](#) [MC78M05ABTG](#)  
[MC78M05ACDT](#) [MC78M05ACDTG](#) [MC78M05ACDTRK](#) [MC78M05ACDTRKG](#) [MC78M05ACT](#) [MC78M05ACTG](#)  
[MC78M05BDT](#) [MC78M05BDTG](#) [MC78M05BDTRK](#) [MC78M05BDTRKG](#) [MC78M05BT](#) [MC78M05BTG](#)  
[MC78M05CDT](#) [MC78M05CDTG](#) [MC78M05CDTRK](#) [MC78M05CDTRKG](#) [MC78M05CDTT5](#) [MC78M05CDTT5G](#)  
[MC78M05CT](#) [MC78M05CTG](#) [MC78M06BT](#) [MC78M06BTG](#) [MC78M06CDT](#) [MC78M06CDTG](#) [MC78M06CDTRK](#)  
[MC78M06CDTRKG](#) [MC78M06CT](#) [MC78M06CTG](#) [MC78M08ABDT](#) [MC78M08ABDTG](#) [MC78M08ABDTRK](#)  
[MC78M08ABDTRKG](#) [MC78M08ABT](#) [MC78M08ABTG](#) [MC78M08ACDT](#) [MC78M08ACDTG](#) [MC78M08ACDTRK](#)  
[MC78M08ACDTRKG](#) [MC78M08ACT](#) [MC78M08ACTG](#) [MC78M08BDT](#) [MC78M08BDTG](#) [MC78M08BDTRK](#)  
[MC78M08BDTRKG](#) [MC78M08BT](#) [MC78M08BTG](#) [MC78M08CDT](#) [MC78M08CDTG](#) [MC78M08CDTRK](#)  
[MC78M08CDTRKG](#) [MC78M08CT](#) [MC78M08CTG](#) [MC78M09BDT](#) [MC78M09BDTG](#) [MC78M09BDTRK](#)  
[MC78M09BDTRKG](#) [MC78M09CDT](#) [MC78M09CDTG](#) [MC78M09CDTRK](#) [MC78M09CDTRKG](#) [MC78M09CT](#)  
[MC78M09CTG](#) [MC78M12ABDT](#) [MC78M12ABDTG](#) [MC78M12ABDTRK](#) [MC78M12ABDTRKG](#) [MC78M12ABT](#)  
[MC78M12ABTG](#) [MC78M12ACDT](#) [MC78M12ACDTG](#) [MC78M12ACDTRK](#) [MC78M12ACDTRKG](#) [MC78M12ACT](#)  
[MC78M12ACTG](#) [MC78M12BDT](#) [MC78M12BDTG](#) [MC78M12BDTRK](#) [MC78M12BDTRKG](#) [MC78M12BT](#)  
[MC78M12BTG](#) [MC78M12CDT](#) [MC78M12CDTG](#) [MC78M12CDTRK](#) [MC78M12CDTRKG](#) [MC78M12CT](#)  
[MC78M12CTG](#) [MC78M15ABDT](#) [MC78M15ABDTG](#) [MC78M15ABDTRK](#) [MC78M15ABDTRKG](#) [MC78M15ABT](#)  
[MC78M15ABTG](#) [MC78M15ACDT](#) [MC78M15ACDTG](#)