



DC input side



AC output side



Features

- Compact size and light weight
- True sine wave output (THD<3%)
- High surge power up to 900W
- Temperature controlled cooling fan
- AC output voltage and frequency selectable by DIP S.W
- No load dissipation <1.5W max. at standby saving mode
- -25°C~+70°C wide operating temperature
- Power ON-OFF remote control
- Front panel indicator for operation status
- Protections :
Input : Reverse polarity / DC low alarm / DC low shutdown / Over voltage
Output : Short circuit / Overload / Over temp.
- Battery over discharge protection(Low voltage disconnect)
- Suitable for lead-acid or li-ion batteries
- Carry handle accessory available(Order NO.: DS-Carry handle, sold separately)
- Conformal coating
- 3 years warranty

Applications

- Mobile device
- Home and office appliance
- Power tools
- Portable equipment
- Vehicle
- Yacht
- Off-grid solar power system
- Wireless network
- Telecom or datacom system

Description

NTS-450 is a 450W highly reliable off-grid true sine wave DC-AC power inverter. Its key features include: digital design with MCU control, streamlined control circuitry that quickly responds to environmental changes and improves reliability, high quality fan with low acoustic noise, 900W peak power, adjustable AC output voltage and frequency, -25~+70°C wide operating temperature range, complete protections features, and etc. combined with batteries, the NTS-450 is suitable for use in residential, commercial, marine, automobile, mine, construction site, and remote areas with no access to utility power, and the output can be used to power fans, TV, radio, phone charger, PC/laptop, lighting, electromechanical tool, communication equipment, power distribution cabinet, outdoor camping equipment, marine AC power, factory equipment, and etc.

Model Encoding

NTS - 450 - 1 12 US

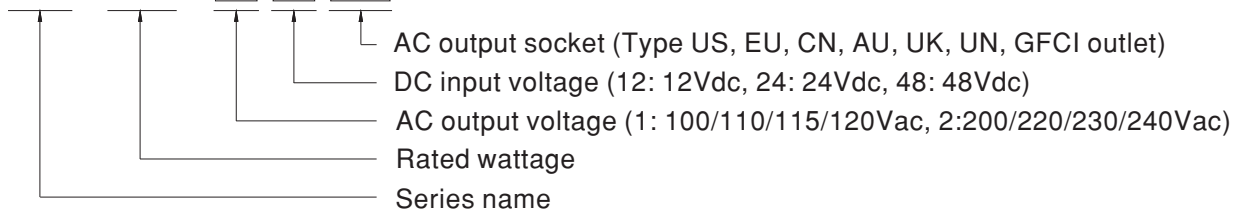

SPECIFICATION

MODEL NO.		NTS-450-112 <input type="checkbox"/>	NTS-450-124 <input type="checkbox"/>	NTS-450-148 <input type="checkbox"/>	NTS-450-212 <input type="checkbox"/>	NTS-450-224 <input type="checkbox"/>	NTS-450-248 <input type="checkbox"/>		
		<input type="checkbox"/> = US, GFCI, UN			<input type="checkbox"/> = EU, CN, AU, UK, UN				
AC OUTPUT	RATED POWER(Continuous)	450W							
	OVER RATED POWER(3 Min.)	517.5W							
	PEAK POWER(10 Sec.)	675W							
	SURGE POWER(30 Cycles)	900W							
	AC VOLTAGE	Default setting set at 110VAC 100 / 110 / 115 / 120Vac selectable by DIP S.W			Default setting set at 230VAC 200 / 220 / 230 / 240Vac selectable by DIP S.W				
	FREQUENCY	Default setting set at 60Hz ± 0.1Hz 50/60Hz selectable by DIP S.W			Default setting set at 50Hz ± 0.1Hz 50/60Hz selectable by DIP S.W				
	WAVEFORM	Note.1 True sine wave (THD<3%)							
	AC REGULATION	± 3.0% at rated input voltage							
FRONT PANEL LED	Please refer to page5								
DC INPUT	DC VOLTAGE	12V	24V	48V	12V	24V	48V		
	VOLTAGE RANGE (Typ.)	10 ~ 16.5Vdc	20 ~ 33Vdc	40 ~ 66Vdc	10 ~ 16.5Vdc	20 ~ 33Vdc	40 ~ 66Vdc		
	DC CURRENT (Typ.)	50A	25A	14A	50A	25A	14A		
	NO LOAD DISSIPATION (Typ.)	NON-SAVING MODE	10W	10W	12W	10W	10W	12W	
		SAVING MODE	Default disable, ≤ 1.2W ~ 1.5W by models @ auto detec AC output load ≤ 10W will be changed to saving mode						
			1.2W	1.3W	1.5W	1.2W	1.3W	1.5W	
	OFF MODE CURRENT DRAW	≤ 1mA							
	EFFICIENCY (Typ.)	Note.1	88%	91%	91%	90%	93%	93%	
BATTERY TYPES	Lead Acid or li-ion								
PROTECTION	DC INPUT	FUSE (Internal)	40A*2	40A*1	10A*2	40A*2	40A*1	10A*2	
		LOW	ALARM	11 ± 0.3Vdc	22 ± 0.5Vdc	44 ± 1Vdc	11 ± 0.3Vdc	22 ± 0.5Vdc	44 ± 1Vdc
			SHUTDOWN	10 ± 0.3Vdc	20 ± 0.5Vdc	40 ± 1Vdc	10 ± 0.3Vdc	20 ± 0.5Vdc	40 ± 1Vdc
			RESTART	12.5 ± 0.3Vdc	25 ± 0.5Vdc	50 ± 1Vdc	12.5 ± 0.3Vdc	25 ± 0.5Vdc	50 ± 1Vdc
		HIGH	ALARM	15.5 ± 0.3Vdc	31 ± 0.5Vdc	62 ± 1Vdc	15.5 ± 0.3Vdc	31 ± 0.5Vdc	62 ± 1Vdc
	SHUTDOWN		16.5 ± 0.3Vdc	33 ± 0.5Vdc	66 ± 1Vdc	16.5 ± 0.3Vdc	33 ± 0.5Vdc	66 ± 1Vdc	
	RESTART		15 ± 0.3Vdc	30 ± 0.5Vdc	60 ± 1Vdc	15 ± 0.3Vdc	30 ± 0.5Vdc	60 ± 1Vdc	
		BAT. POLARITY	By internal fuse open						
	AC OUTPUT	OVER TEMPERATURE	Protection type : Shut down o/p voltage, re-power on to recover						
		OUTPUT SHORT	Protection type : Shut down o/p voltage, re-power on to recover						
OVER LOAD (Typ.)		105 ~ 115% load for 180 sec., 115% ~ 150% load for 10 sec. Protection type : Shut down o/p voltage, re-power on to recover							
GFCI PROTECTION		Design refer to UL458 (Only for "GFCI" AC socket , by request)			None				
FUNCTION	REMOTE CONTROL	Power ON-OFF remote control by front panel dry contact connector (by RELAY); Open : Normal work ; Short , Remote off							
ENVIRONMENT	WORKING TEMP.	-25 ~ +70°C (Refer to "Derating curve")							
	WORKING HUMIDITY	20% ~ 90% RH non-condensing							
	STORAGE TEMP., HUMIDITY	-30 ~ +70°C / -22 ~ +158°F, 10 ~ 95% RH non-condensing							
	VIBRATION	10 ~ 500Hz, 3G 10min./1cycle, 60min. each along X, Y, Z axes							
SAFETY & EMC (Note.4)	SAFETY STANDARDS	CB IEC62368-1, Dekra BS EN/EN62368-1, E13, EAC TP TC 004 approved; Design refer to AS/NZS 62368.1 (Please refer to next page "AC output socket" table for more details) ; Design refer to UL458 (By request)							
	WITHSTAND VOLTAGE	DC I/P - AC O/P: 3.0KVac AC O/P - FG: 1.5KVac							
	EMC EMISSION	Parameter	Standard				Test Level / Note		
		Radiated	FCC for 112,124,148 only(expect for Type-UN)				Class A		
			BS EN/EN55032(CISPR32) for 212,224,248 only(expect for Type-UN)				Class A		
		Harmonic Current	BS EN/EN61000-3-2				-----		
	Voltage Flicker	BS EN/EN61000-3-3				-----			
	EMC IMMUNITY	BS EN/EN55024, BS EN/EN55035							
		Parameter	Standard				Test Level / Note		
		ESD	BS EN/EN61000-4-2				Level 3, 8KV air ; Level 2, 4KV contact		
Radiated		BS EN/EN61000-4-3				Level 2 , 3V/m			
Magnetic Field	BS EN/EN61000-4-8				Level 1 , 1A/m				
OTHERS	MTBF	281.3K hrs min. Telcordia TR/SR-332 (Bellcore) ; 85K hrs min. MIL-HDBK-217F (25°C)							
	DIMENSION	210*130*55mm (L*W*H)							
	PACKING	1.3Kg; 8pcs/ 11.4Kg/ 1.74CUFT							
NOTE	<p>1.Efficiency, AC regulation and THD are tested by 450W, linear load at 12.5Vdc/25Vdc/50Vdc input voltage.</p> <p>2.All parameters not specified above are measured at rated load, 25°C of ambient temperature and set to factory setting.</p> <p>3.Internal pre-start circuit, the setup time is 8s.</p> <p>4.The power supply is considered as an independent unit, but the final equipment still need to re-confirm that the whole system complies with the EMC directives. For guidance on how to perform these EMC tests, please refer to "EMI testing of component power supplies." (as available on http://www.meanwell.com)</p> <p>※ Product Liability Disclaimer : For detailed information, please refer to https://www.meanwell.com/serviceDisclaimer.aspx</p>								

■ AC Output Socket

MODEL NO.	NTS-450-112 <input type="checkbox"/>	NTS-450-124 <input type="checkbox"/>	NTS-450-148 <input type="checkbox"/>	NTS-450-212 <input type="checkbox"/>	NTS-450-224 <input type="checkbox"/>	NTS-450-248 <input type="checkbox"/>		
Socket type								
	TYPE-US	TYPE-GFCI	TYPE-UN	TYPE-EU	TYPE-CN	TYPE-UK	TYPE-AU	TYPE-UN
	Standard	Optional	Standard	Standard	Standard	Optional	Optional	Standard
Country	USA	USA	UNIVERSAL	EUROPE	CHINA	U.K	AUSTRALIA	UNIVERSAL
Certificate			None					

■ DERATING CURVE

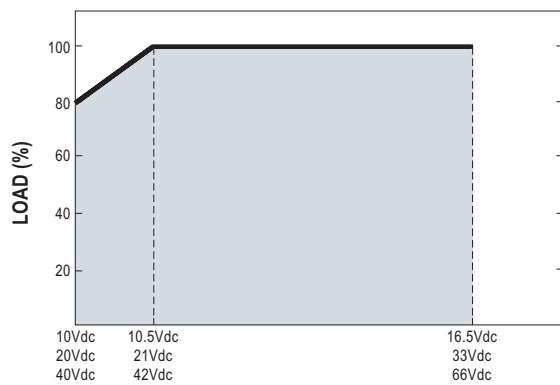
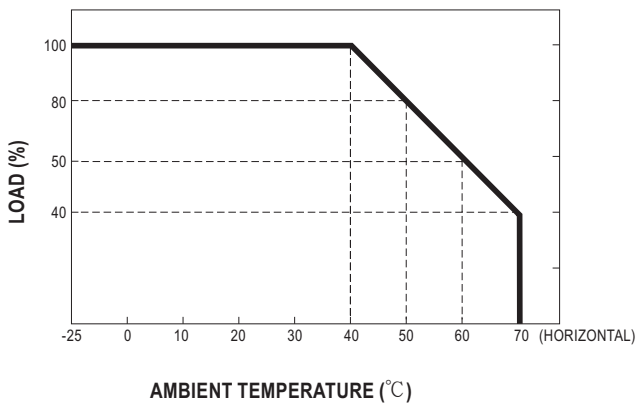

Remote ON-OFF Control

Remote ON-OFF	AC Output Status
Open	power inverter ON
Short	power inverter OFF

AC Output Voltage, Frequency, Power saving mode selectable by DIP SW



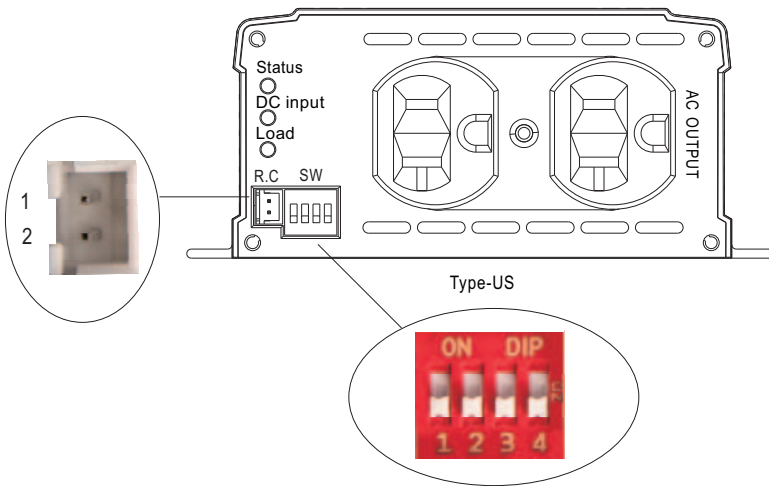

Output voltage and frequency setting factory settings are either 110Vac/60Hz or 230Vac/50Hz, users are able to adjust the voltage and frequency, through the DIP switch of position 1,2,3,4 on the panel.















AC Output Voltage, Frequency, Power saving mode selectable by DIP SW			
SW1	SW2	SW3	SW4
OFF	OFF : 100Vac or 200Vac	ON : 50Hz	ON : Saving mode
OFF	ON : 110Vac or 220Vac		
ON	OFF : 115Vac or 230Vac	OFF: 60Hz	OFF: Non-Saving mode
ON	ON : 120Vac or 240Vac		

■ LED STATUS













Normal work:



	Green	Orange	Red
Status	 Inverter OK	 Remote off  Saving mode	 Abnormal Status (See below table)

	Green	Orange	Red
DC Input	 12.5~15.5Vdc	 11~12.5Vdc	 <11Vdc or >15.5Vdc
	 25~31Vdc	 22~25Vdc	 <22Vdc or >31Vdc
	 50~62Vdc	 44~50Vdc	 <44Vdc or >62Vdc

	Green	Orange	Red
Load	 <40% load	 40~80% load	 >80% load

Abnormal status :

LED Indicator	Abnormal Indication
Status  DC Input  Load 	Output overload or AC output short circuit
Status  DC Input  Load 	Abnormal DC voltage
Status  DC Input  Load 	Over temperature or Fan lock
Status  DC Input  Load 	Inverter fail

-  Light
-  Light off
-  Flash

MECHANICAL SPECIFICATION

Unit:mm

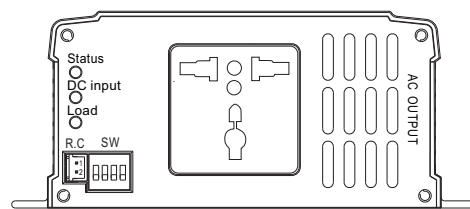
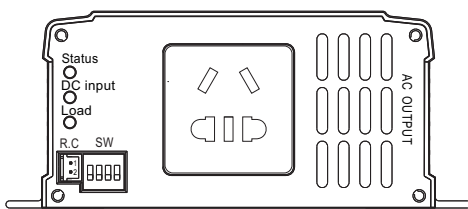
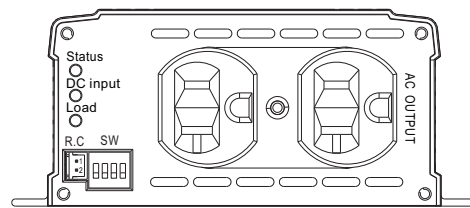
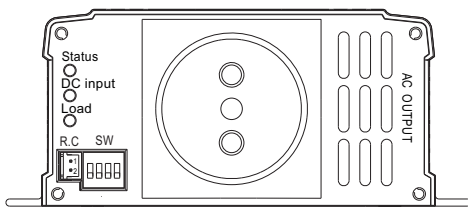
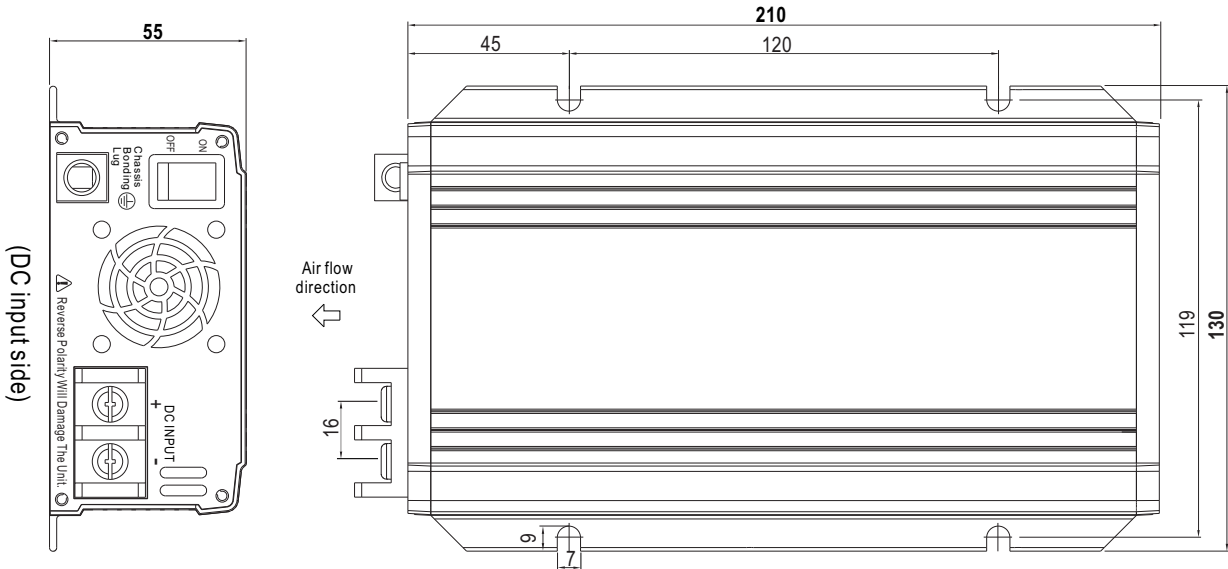



(AC output side)

R.C Connector : JST B-XH or equivalent

Remote Control	Mating Housing	Terminal
Pin 1,2 Open: Normal work	JST XHP or equivalent	JST SXH-001T or equivalent
Pin 1,2 Short: Remote off		

■ Accessory List

※ Carry handle (Optional accessory, Power inverter and Pull handle should ordered seperately)

MW's Order No.	Item		Quantity
DS-Carry Handle	①	Handle 	1
	②	Foot pad 	4
	③	Screw 	2

① Handle

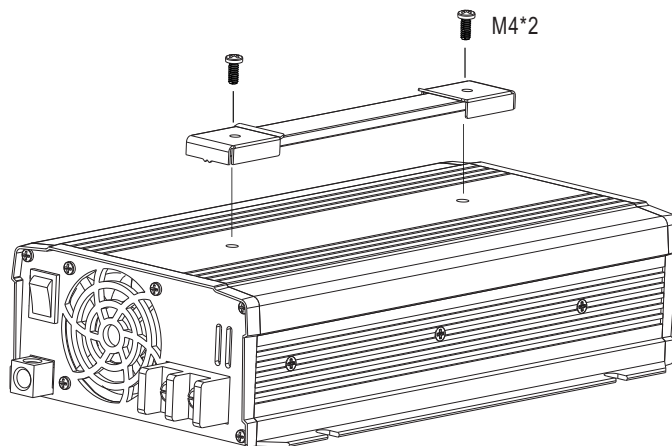

② Foot pad

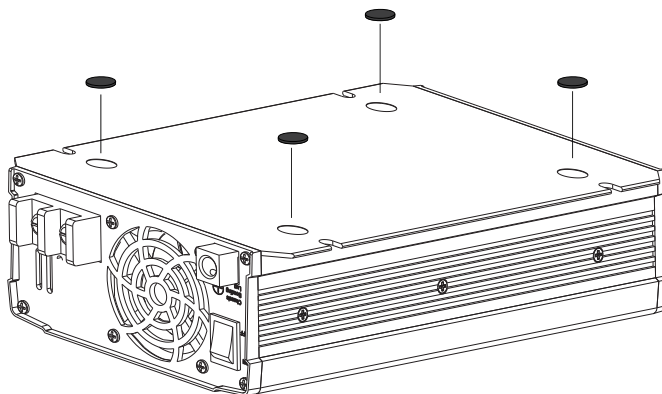

■ TYPICAL APPLICATION



- 1 Battery Bank
- 2 Off-Grid DC/AC Solar Inverter (NTS series)
- 3 AC Outlet



- 1 Utility Input (Shore)
- 2 AC/DC Battery Charger (PB/NPB/NPP series)
- 3 Battery Bank
- 4 Off-Grid DC/AC Power Inverter (NTS series)
- 5 AC Outlet

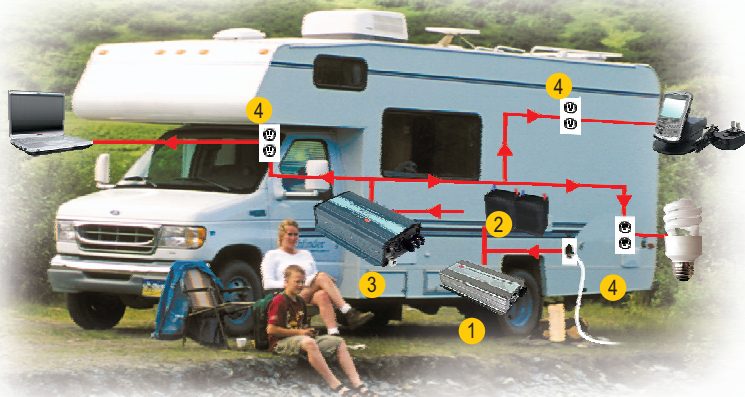

- 1 AC/DC Battery Charger (PB/NPB/NPP series)
- 2 Battery Bank
- 3 Off-Grid DC/AC Inverter (NTS series)
- 4 AC Outlet

■ INSTALLATION MANUAL

Please refer to : <http://www.meanwell.com/manual.html>