



PD55008 - PD55008S

RF POWER TRANSISTORS

The *LdmoST* Plastic FAMILY

PRELIMINARY DATA

N-CHANNEL ENHANCEMENT-MODE LATERAL MOSFETs

- EXCELLENT THERMAL STABILITY
- COMMON SOURCE CONFIGURATION
- POUT = 8 W with 17 dB gain @ 500 MHz / 12.5V
- NEW RF PLASTIC PACKAGE

DESCRIPTION

The PD55008 is a common source N-Channel, enhancement-mode, lateral Field-Effect RF power transistor. It is designed for high gain, broad band commercial and industrial applications. It operates at 12V in common source mode at frequencies of up to 1GHz. PD55008 boasts the excellent gain, linearity and reliability of ST's latest LDMOS technology mounted in the first true SMD plastic RF power package, PowerSO-10RF. PD55008's superior linearity performance makes it an ideal solution for car mobile radio.

The PowerSO-10 plastic package, designed to offer high reliability, is the first ST JEDEC approved, high power SMD package. It has been specially optimized for RF needs and offers excellent RF performances and ease of assembly.

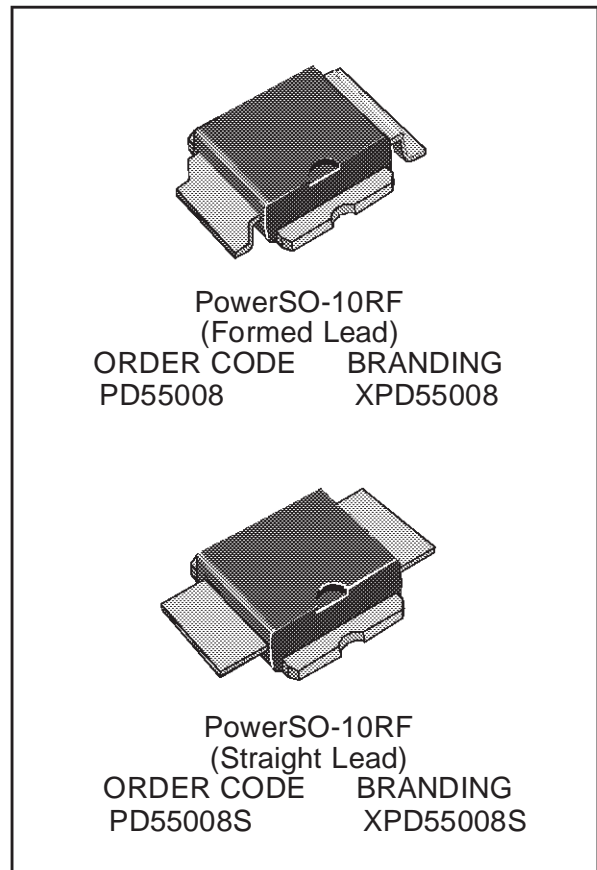

ABSOLUTE MAXIMUM RATINGS ($T_{CASE} = 25^{\circ}C$)

Symbol	Parameter	Value	Unit
$V_{(BR)DSS}$	Drain Source Voltage	40	V
V_{GS}	Gate-Source Voltage	± 20	V
I_D	Drain Current	4	A
P_{DISS}	Power Dissipation (@ $T_c = 70^{\circ}C$)	52.8	W
T_j	Max. Operating Junction Temperature	165	$^{\circ}C$
T_{STG}	Storage Temperature	-65 to 165	$^{\circ}C$

THERMAL DATA

$R_{th(j-c)}$	Junction-Case Thermal Resistance	1.8	$^{\circ}C/W$
---------------	----------------------------------	-----	---------------

PD55008 - PD55008S

ELECTRICAL SPECIFICATION($T_{CASE} = 25\text{ }^{\circ}\text{C}$)

STATIC

Symbol	Parameter		Min.	Typ.	Max.	Unit
I_{DSS}	$V_{GS} = 0\text{ V}$	$V_{DS} = 28\text{ V}$			1	μA
I_{GSS}	$V_{GS} = 20\text{ V}$	$V_{DS} = 0\text{ V}$			1	μA
$V_{GS(Q)}$	$V_{DS} = 10\text{ V}$	$I_D = 150\text{ mA}$	2.0		5.0	V
$V_{DS(ON)}$	$V_{GS} = 10\text{ V}$	$I_D = 1.5\text{ A}$			1.0	V
g_{FS}	$V_{DS} = 10\text{ V}$	$I_D = 1.5\text{ A}$		1.6		mho
C_{ISS}	$V_{GS} = 0\text{ V}$	$V_{DS} = 12.5\text{ V}$	$f = 1\text{ MHz}$		58	pF
C_{OSS}	$V_{GS} = 0\text{ V}$	$V_{DS} = 12.5\text{ V}$	$f = 1\text{ MHz}$		39	pF
C_{RSS}	$V_{GS} = 0\text{ V}$	$V_{DS} = 12.5\text{ V}$	$f = 1\text{ MHz}$		2.6	pF

DYNAMIC

Symbol	Parameter				Min.	Typ.	Max.	Unit
P_{OUT}	$f = 500\text{ MHz}$	$V_{DD} = 12.5\text{ V}$	$I_{DQ} = 150\text{ mA}$		8			W
G_{PS}	$f = 500\text{ MHz}$	$V_{DD} = 12.5\text{ V}$	$P_{OUT} = 8\text{ W}$	$I_{DQ} = 150\text{ mA}$		17		dB
η_D	$f = 500\text{ MHz}$	$V_{DD} = 12.5\text{ V}$	$P_{OUT} = 8\text{ W}$	$I_{DQ} = 150\text{ mA}$		55		%
LOAD Mismatch	$f = 500\text{ MHz}$ ALL PHASE ANGLES	$V_{DD} = 15.5\text{ V}$	$P_{OUT} = 8\text{ W}$	$I_{DQ} = 150\text{ mA}$	20:1			VSWR

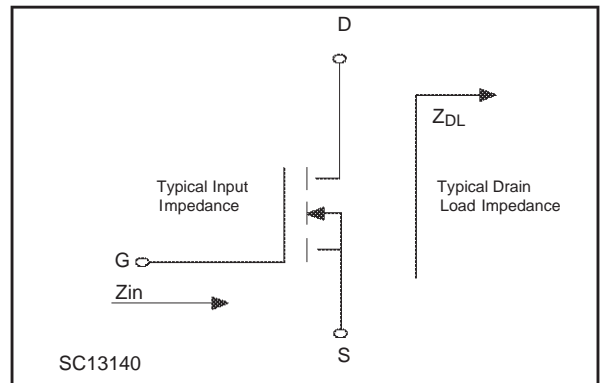
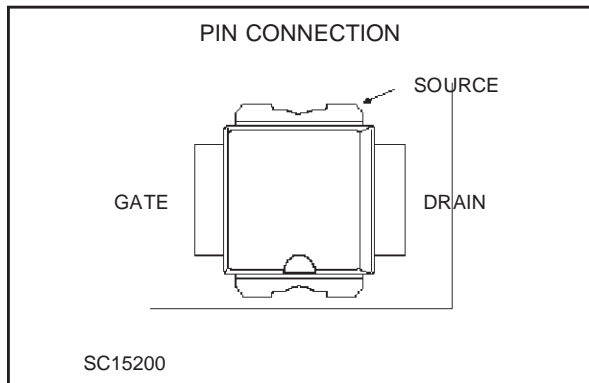

IMPEDANCE DATA

PD55008

Frequency MHz	Z_{in} Ω	Z_{dl} Ω
520	$1.649 - j1.965$	$1.716 - j1.552$
500	$1.589 - j1.185$	$1.561 - j2.639$
480	$1.141 - j2.054$	$1.649 - j2.916$

PD55008S

Frequency MHz	Z_{in} Ω	Z_{dl} Ω
520	$1.586 - j2.087$	$3.082 + j2.043$
500	$1.409 - j3.448$	$2.129 + j3.219$
480	$1.075 - j2.727$	$2.046 + j1.960$

TYPICAL PERFORMANCE

Capacitance vs. Drain Voltage

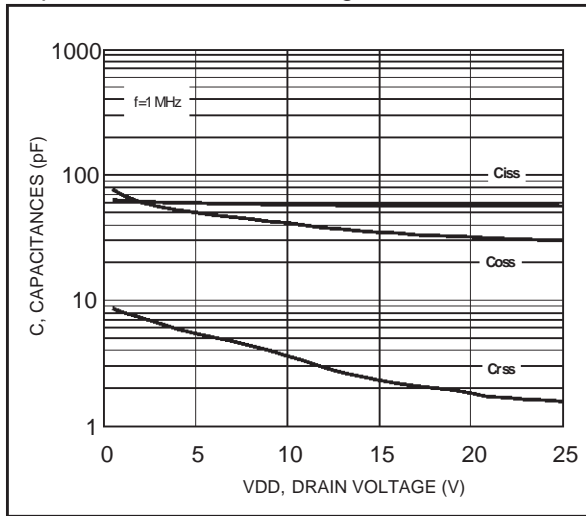

Drain Current vs. Gate Voltage

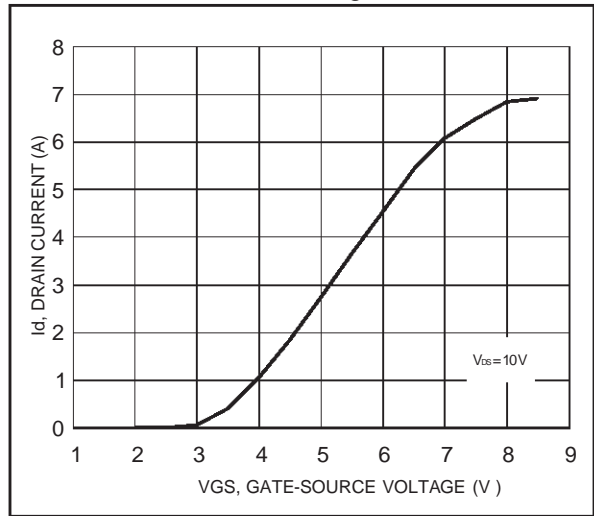

Gate-Source vs. Case Temperature

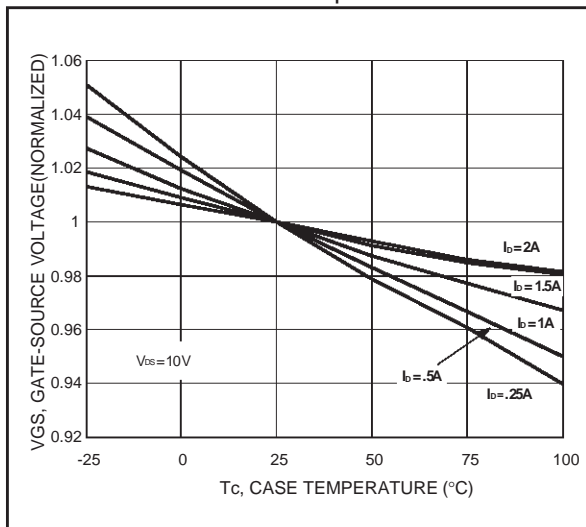

PD55008 - PD55008S

TYPICAL PERFORMANCE

Output Power vs. Input Power

PD55008

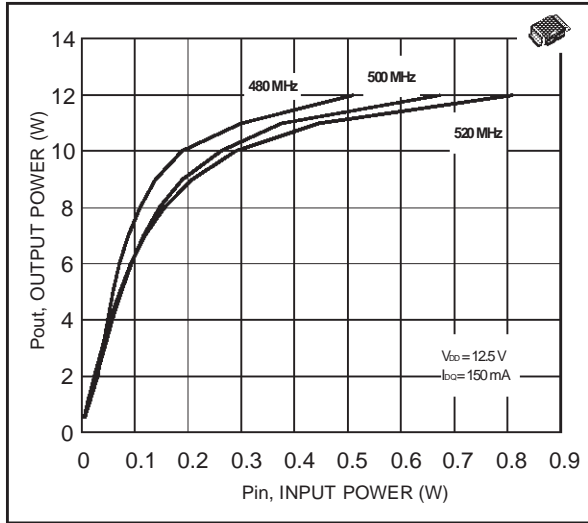

Power Gain vs. Output Power

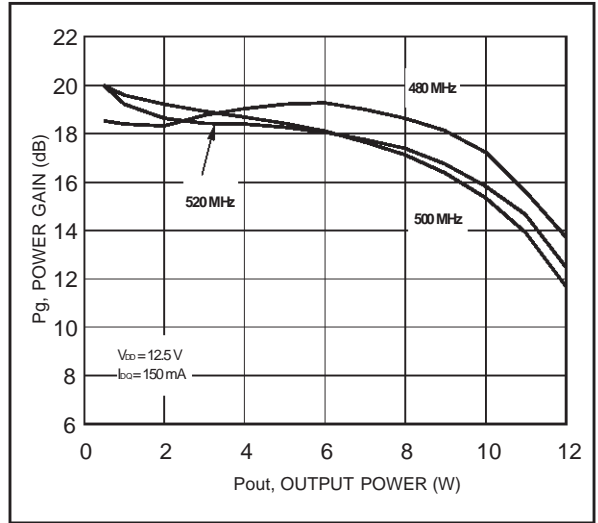

Drain Efficiency vs. Output Power

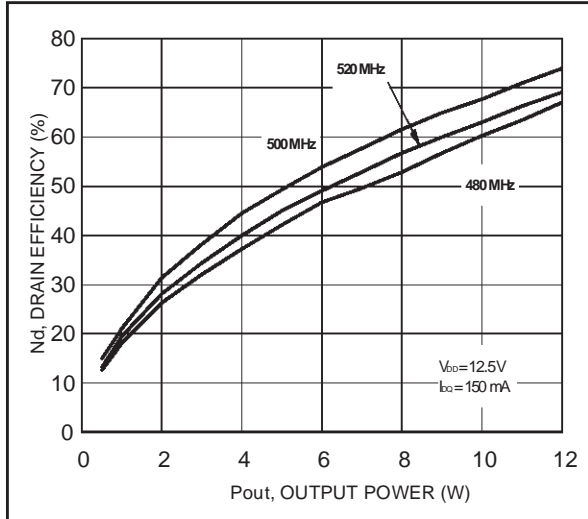

Input Return Loss vs. Output Power

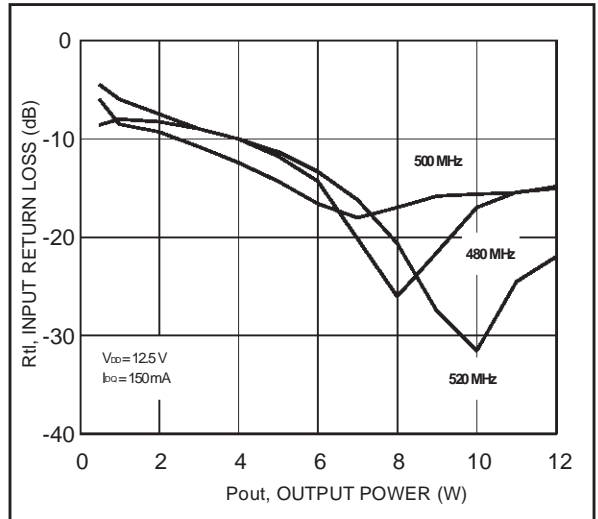

Output Power vs. Bias Current

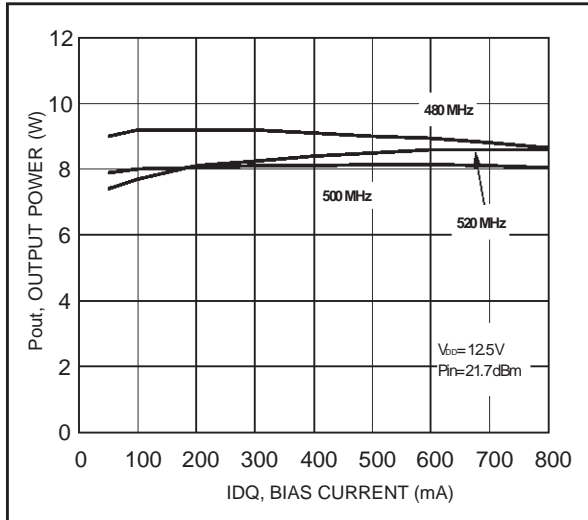

Drain Efficiency vs. Bias Current

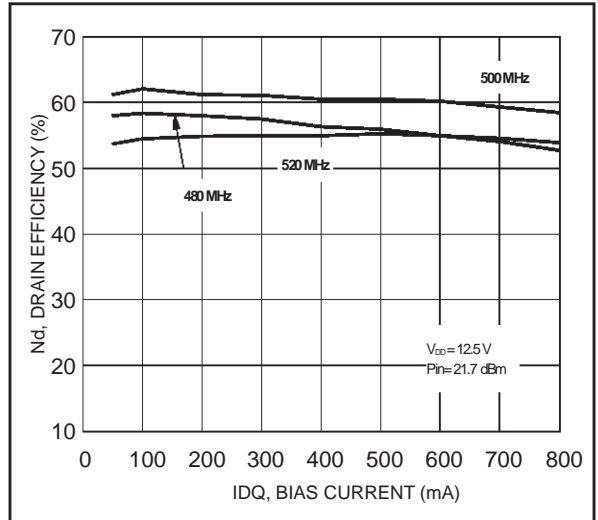

TYPICAL PERFORMANCE

Output Power vs. Supply Voltage

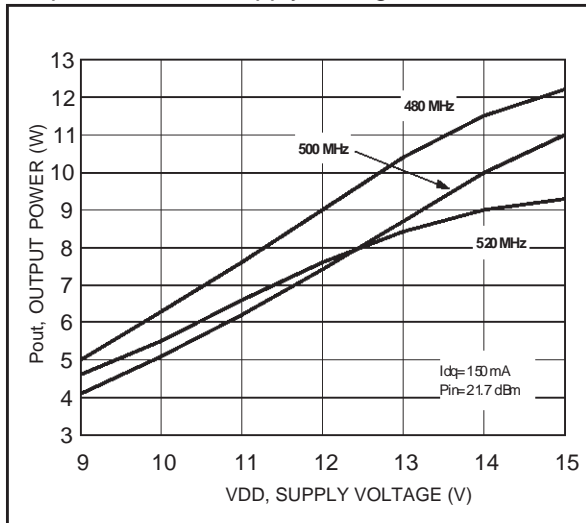

Drain Efficiency vs. Supply Voltage

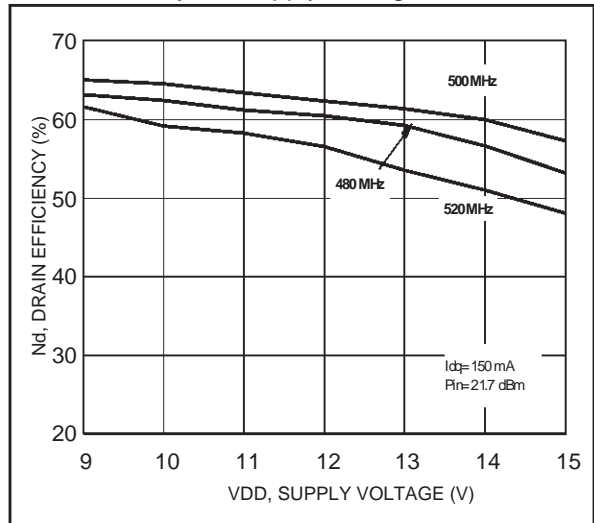

Output Power vs. Gate-Source Voltage

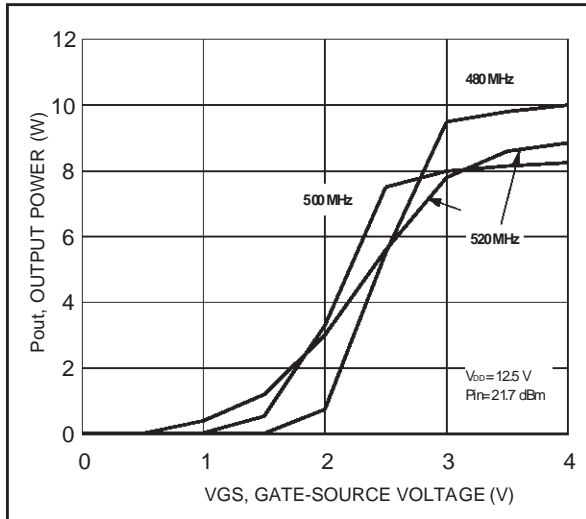

Output Power vs. Input Power PD55008S

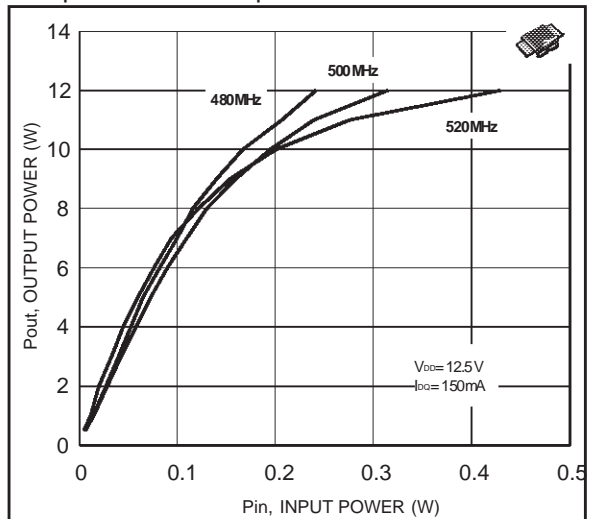

Power Gain vs. Output Power

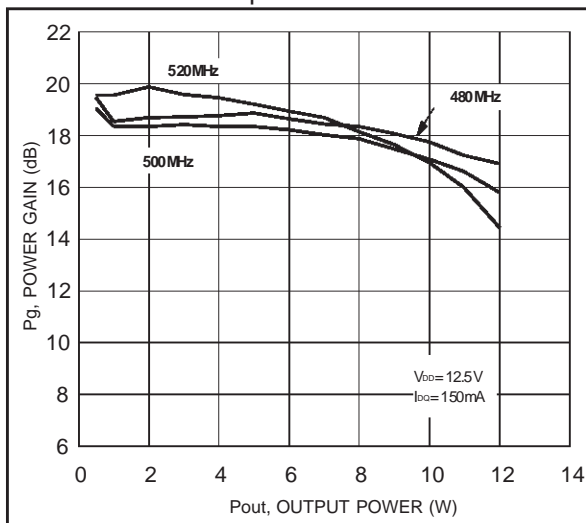

Drain Efficiency vs. Output Power

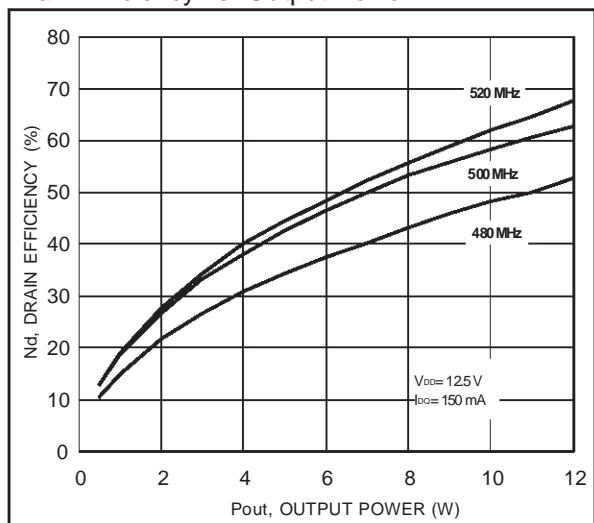

PD55008 - PD55008S

TYPICAL PERFORMANCE

Input Return Loss vs. Output Power

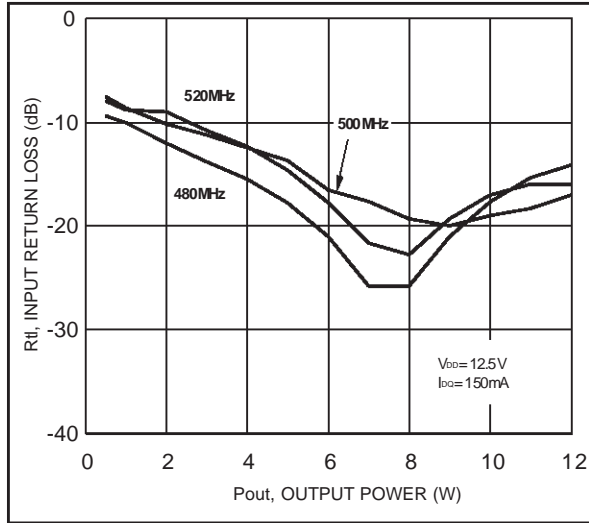

Output Power vs. Bias Current

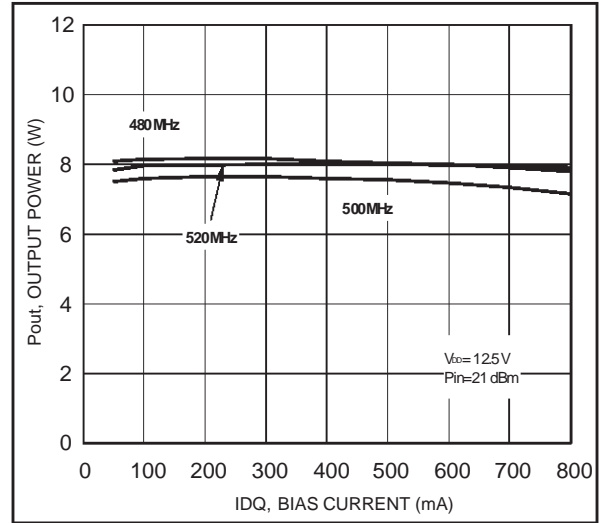

Drain Efficiency vs. Bias Current

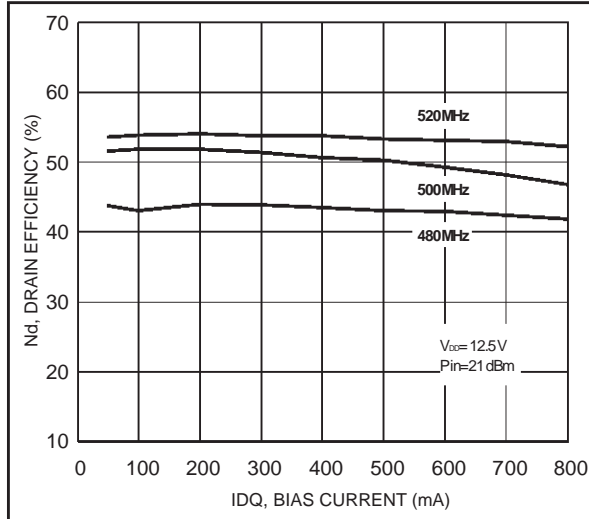

Output Power vs. Supply Voltage

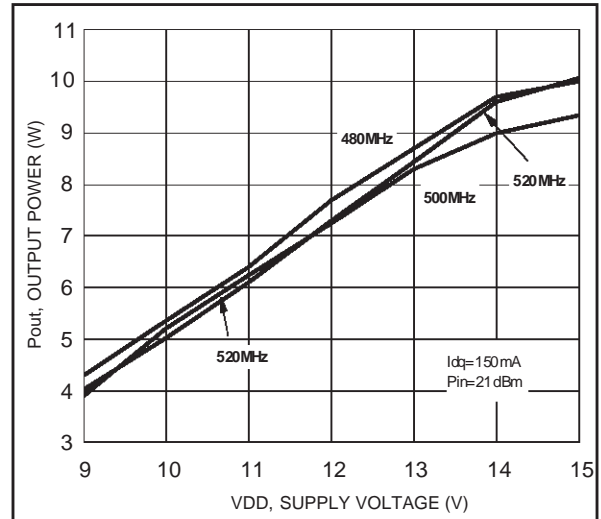

Drain Efficiency vs. Supply Voltage

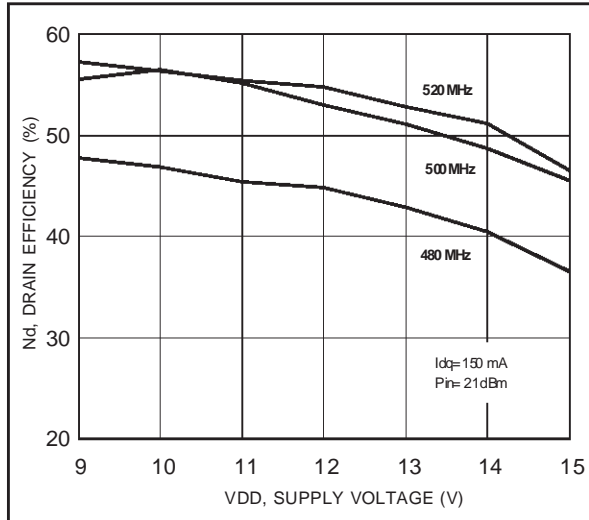

Output Power vs. Gate-Source Voltage

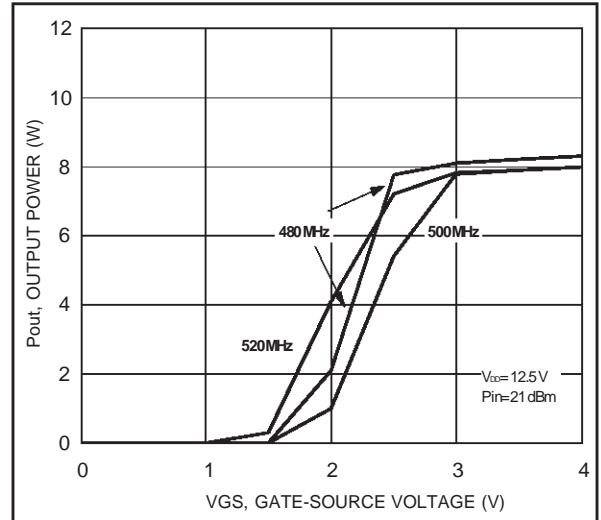

TEST CIRCUIT SCHEMATIC

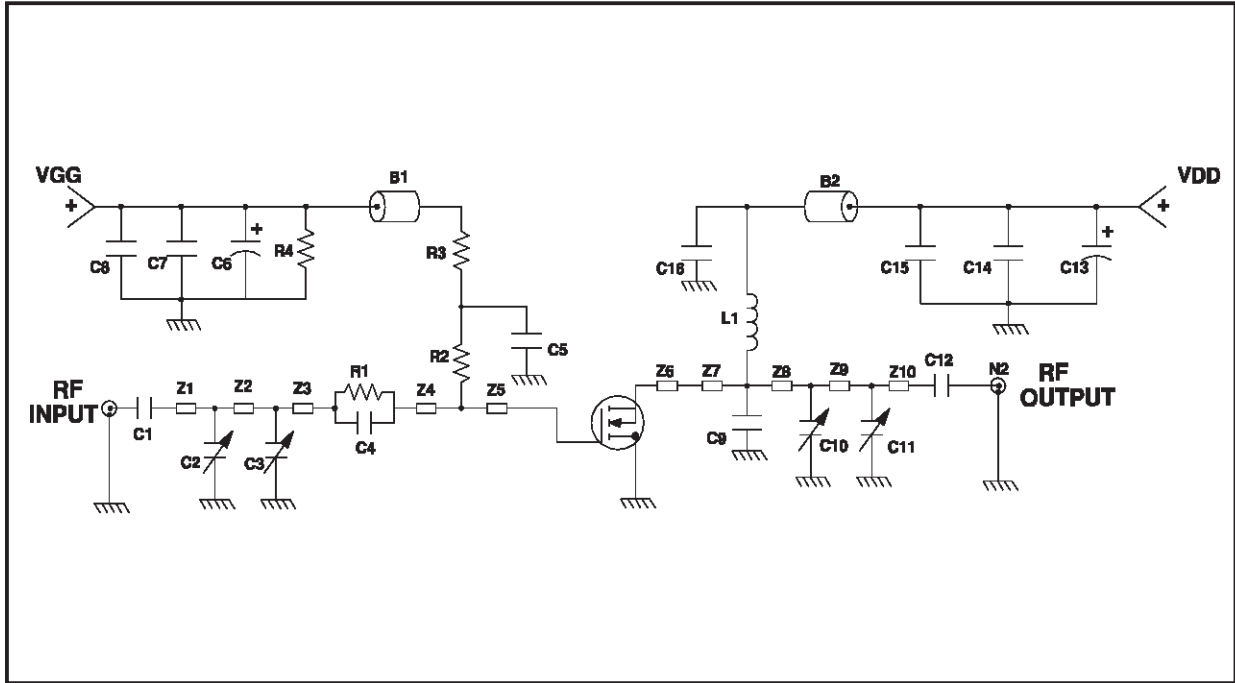

TEST CIRCUIT COMPONENT PART LIST

B1,B2	SHORT FERRITT BEAD, FAIR RITE PRODUCTS (2743021446)	R4	33K Ω , 1/8 W RESISTOR
C1,C12	240pF, 100 mil CHIP CAPACITOR	Z1	0.451" X 0.080" MICROSTRIP
C2,C3,C10,C11	0 to 20 pF TRIMMER CAPACITOR	Z2	1.005" X 0.080" MICROSTRIP
C4	82pF, 100 mil CHIP CAP	Z3	0.020" X 0.080" MICROSTRIP
C5,C16	120pF, 100 mil CHIP CAP	Z4	0.155" X 0.080" MICROSTRIP
C6,C13	10 μ F, 50V ELECTROLYTIC CAPACITOR	Z5,Z6	0.260" X 0.223" MICROSTRIP
C7,C14	1.200pF mil CHIP CAP	Z7	0.065" X 0.080" MICROSTRIP
C8,C15	0.1 F, 100 mil CHIP CAP	Z8	0.266" X 0.080" MICROSTRIP
C9	30pF, 100 mil CHIP CAP	Z9	1.113" X 0.080" MICROSTRIP
L1	55.5 nH, TURN, COILCRAFT	Z10	0.433" X 0.080" MICROSTRIP
N1,N2	TYPE N FLANGE MOUNT	BOARD	ROGER, ULTRA LAM 2000
R1	15 Ω , 0805 CHIP RESISTOR		THK 0.030" $\epsilon_r = 2.55$
R2	51 Ω , 1/2 W RESISTOR		2oz ED Cu 2 SIDES
R3	10 Ω , 0805 CHIP RESISTOR		

PD55008 - PD55008S

TEST CIRCUIT

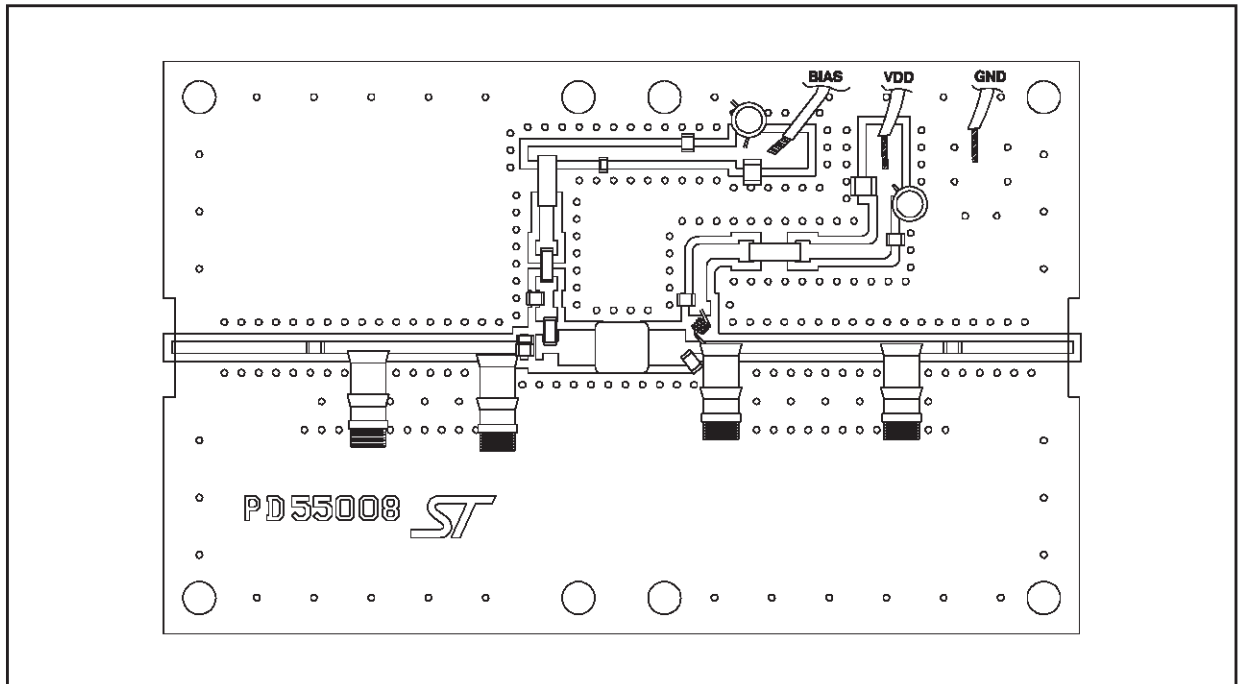

TEST CIRCUIT PHOTOMASTER

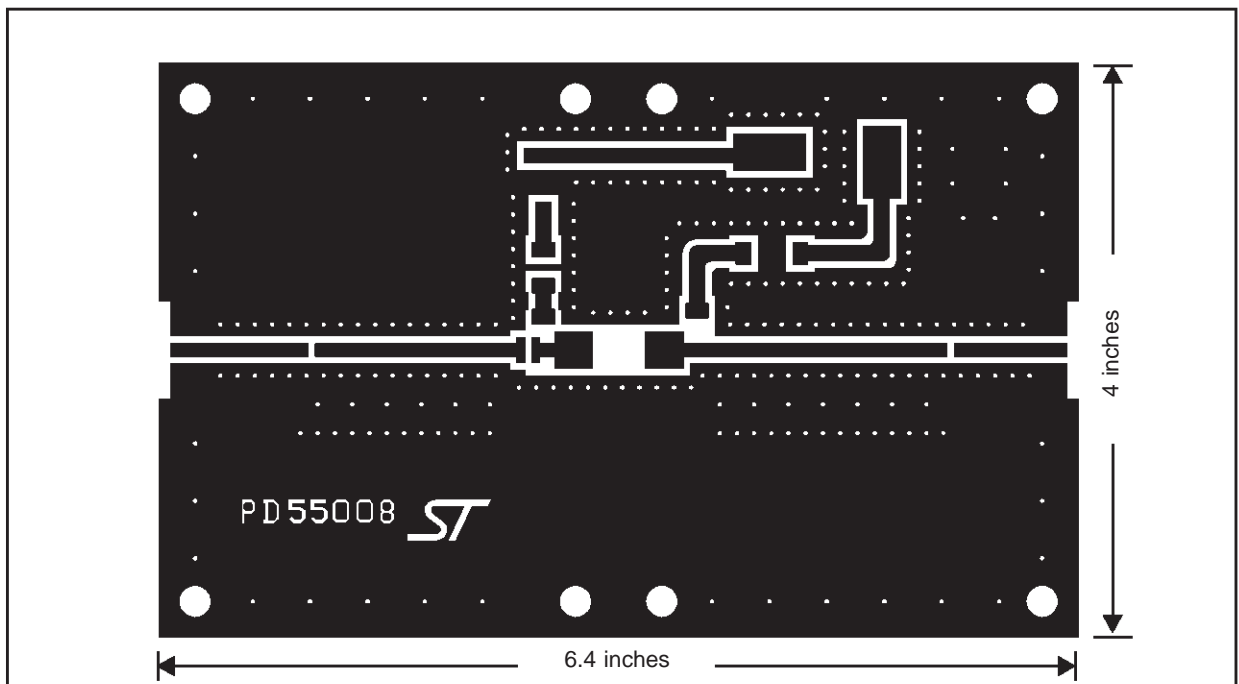

PowerSO-10RF (Straight Lead) MECHANICAL DATA

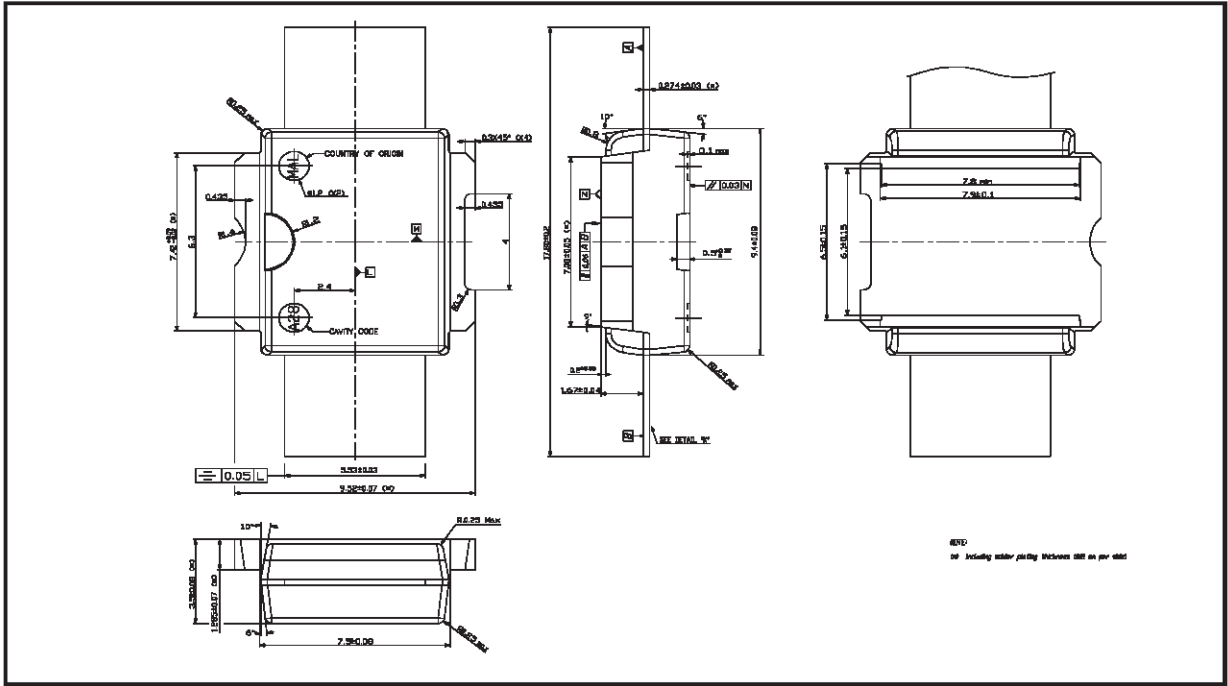

PowerSO-10RF (Formed Lead) MECHANICAL DATA

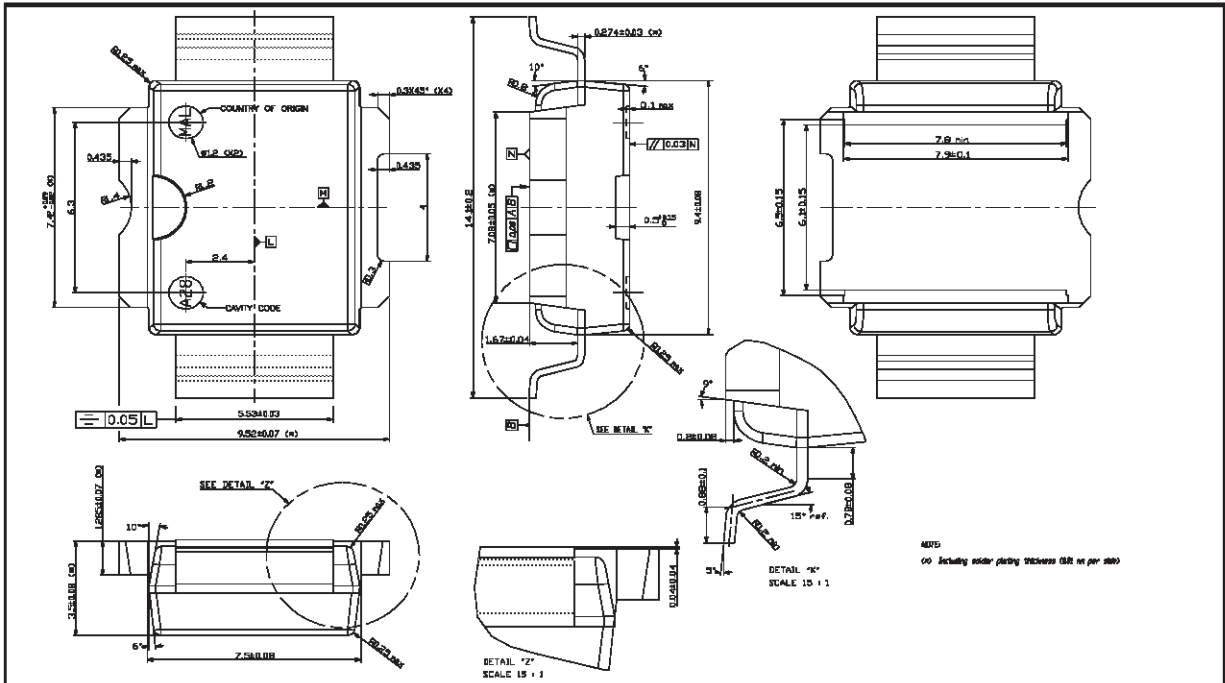

Information furnished is believed to be accurate and reliable. However, STMicroelectronics assumes no responsibility for the consequences of use of such information nor for any infringement of patents or other rights of third parties which may result from its use. No license is granted by implication or otherwise under any patent or patent rights of STMicroelectronics. Specifications mentioned in this publication are subject to change without notice. This publication supersedes and replaces all information previously supplied. STMicroelectronics products are not authorized for use as critical components in life support devices or systems without express written approval of STMicroelectronics.

The ST logo is registered trademark of STMicroelectronics
® 2000 STMicroelectronics - All Rights Reserved

All other names are the property of their respective owners.

STMicroelectronics GROUP OF COMPANIES
Australia - Brazil - China - Finland - France - Germany - Hong Kong - India - Italy - Japan - Malaysia - Malta - Morocco -
Singapore - Spain - Sweden - Switzerland - United Kingdom - U.S.A.

<http://www.st.com>