

HFKM/HFKS

AUTOMOTIVE RELAY

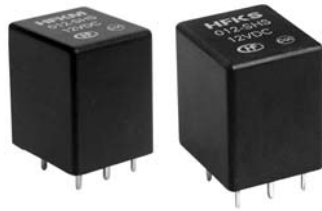

Typical Applications

Flasher control, Indicator control, Power door & windows, Low temperature start, Immobilizers, Central door lock, Sunproof motor control

Features

- Switching capability up to 20A
- Six different contact arrangements
- Open and sealed types available
- Two terminals size for HFKM & HFKS
- RoHS & ELV compliant (555)

CHARACTERISTICS

Contact arrangement	1A, 1B, 1C, 1W, 1U, 1V	Min. contact load	0.5A 6VDC
Voltage drop (initial) ¹⁾	Typ.: 100mV (at 10A)	Electrical life	See "CONTACT DATA" table
	Max.: 250mV (at 10A)	Mechanical life	1 x 10 ⁷ OPS 300OPS/min
Max. make current ²⁾	1A:60A	Initial insulation resistance	100MΩ (500VDC)
	1B:12A	Dielectric strength	500VAC (1min, leakage current less than 1mA)
	1C(NO/NC): 60/12A		
	1U: Resistive/Inductive: 2×40A	Operate time	Max.: 3ms (at nomi. vol.)
	Lamp: 2×60A (AgSnO ₂)	Release time	Max.: 1.5ms ³⁾
1V:2×8A	Coil max. allowable temp.	155°C	
Max. switching voltage	1W(NO/NC):2×30A/2×5A	Ambient temperature	-40°C to +85°C
	75VDC	Storage temperature	-40°C to +155°C
Max. switching current	1A: 20A, 1B: 10A	Vibration resistance	10Hz to 55Hz 1.5mm DA
	1C(NO/NC): 20A/10A	Shock resistance	Acceleration10g (11ms)
	1U:Resistive, Inductive: 2×20A	Termination	PCB ⁴⁾
	Lamp: 2×6A (AgSnO ₂)	Construction	Sealed IP67 & Open
	1V: 2×7A	Unit weight	Open: Approx. 8g
1W(NO/NC): 2×15A/2×5A	Sealed: Approx.12g		
Max. switching power	200W	1) Equivalent to the max. initial contact resistance is 100mΩ (at 1A 6VDC).	
Continuous current	1A:15A, 1B:10A	2) Max. make current is the max. shock current of lamp load.	
	1C(NO/NC):15A/10A	3) The value is measured when voltage drops suddenly from nominal voltage to 0 VDC and coil is not paralleled with suppression circuit.	
	1U:2×10A, 1V: 2×7A	4) Since it is an environmental friendly product, please select lead-free solder when welding.The recommended soldering temperature is 240°C to 260°C.	
	1W(NO/NC): 2×7A/2×5A		

CONTACT DATA ⁴⁾

at 20°C

Load voltage	Load type		Load current (A)				On/Off ratio		Electrical life (OPS)	Contact material ¹⁾	Load wiring diagram ³⁾	
			1C		1A		1B	On (s)				Off (s)
			NO	NC	NO	NC						
13.5VDC	Resistive	Make	15	10	15	10	2	2	2×10 ⁵	AgSnO ₂ AgNi0.15	See diagram 1	
		Break	15	10	15	10	2	2				
	Lamp ²⁾	Make	3×21W	---	3×21W	---	2	2	1.5×10 ⁶	AgSnO ₂	See diagram 2	
		Break		---		---	2	2				



HONGFA RELAY

ISO9001、ISO/TS16949、ISO14001、OHSAS18001 CERTIFIED

2006 Rev. 1.01

Load voltage	Load type		Load current (A)				On/Off ratio		Electrical life (OPS)	Contact material ¹⁾	Load wiring diagram ³⁾
			1W		1U	1V	On (s)	Off (s)			
			NO	NC	NO	NC					
13.5VDC	Resistive	Make	2×7	2×5	2×7	2×5	2	2	2×10 ⁵	AgSnO ₂ AgNi0.15	See diagram 3
		Break	2×7	2×5	2×7	2×5	2	2			
	Lamp	Make	(6x21W)	---	(6x21W)	---	2	2	1.5×10 ⁶	AgSnO ₂	See diagram 4
		Break		---		---	2	2			
	Flasher	Make	(4x21W)	---	(4x21W)	---	0.375	0.375	2×10 ⁶	Special AgSnO ₂	See diagram 4
		Break	x2	---	x2	---					
	Lamp	Make	(2x21W +1x5W)	---	(2x21W +1x5W)	---	0.2	3	1×10 ⁵	AgSnO ₂	See diagram 2
		Break	x2	---	x2	---					

- 1) AgSnO₂ contact is suitable for the lamp load, inductive load and motor load, while AgNi contact is suitable for resistive load;
- 2) When it is utilized in flasher, a special AgSnO₂ contact material should be used and the ordering key should be 170 as a special suffix. Please connect by the polarity according to the diagrams below.
- 3) The load wiring diagrams are listed below. When special AgSnO₂ contacts are applied, please heed the anode and cathode's request when wired.

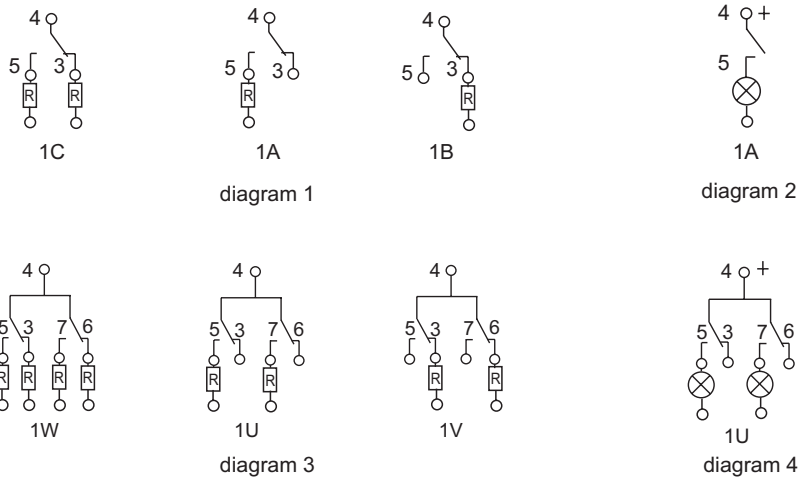

- 4) When the load requirement is different from content of the table above, please contact Hongfa for relay application support.

COIL DATA

at 20°C

Nominal voltage (VDC)	Pick-up voltage (VDC)		Drop-out voltage (VDC)		Coil resistance (Ω±10%)	Power consumption (W)	Max. allowable overdrive voltage ¹⁾ (VDC)
	1A, 1B, 1C, 1U, 1V	1W	1B, 1V	1A, 1C, 1U, 1W			
6	3.75	4.5	0.35	0.7	28	1.1	9.0
12	7.5	9.0	0.7	1.4	130	1.1	19.6
24	15	18.0	1.4	2.8	520	1.1	39.3

- 1) Max. allowable overdrive voltage is stated with 10A load applied.

ORDERING INFORMATION

Type	HFKM ¹⁾ / HFKS ¹⁾ /		012	1H	S	T	XXX
Coil voltage	006: 6VDC, 012: 12VDC, 024: 24VDC						
Contact arrangement	1H: 1 Form A SH: 1 Form U	1D: 1 Form B SD: 1 Form V	1Z: 1 Form C SZ: 1 Form W				
Structure	S: Sealed IP67		Nil: Open				
Contact material	T: AgSnO ₂		Nil: AgNi0.15				

Customer special code e.g. 170 stands for flasher load, 555 stands for RoHS & ELV compliant. In case there are multiple special requirements, all special codes should be followed one by one.

1) HFKM/HFKS is an environmental friendly product, please mark special code (555) when order.

OUTLINE DIMENSIONS, WIRING DIAGRAM AND PC BOARD LAYOUT

Unit: mm

Outline Dimensions

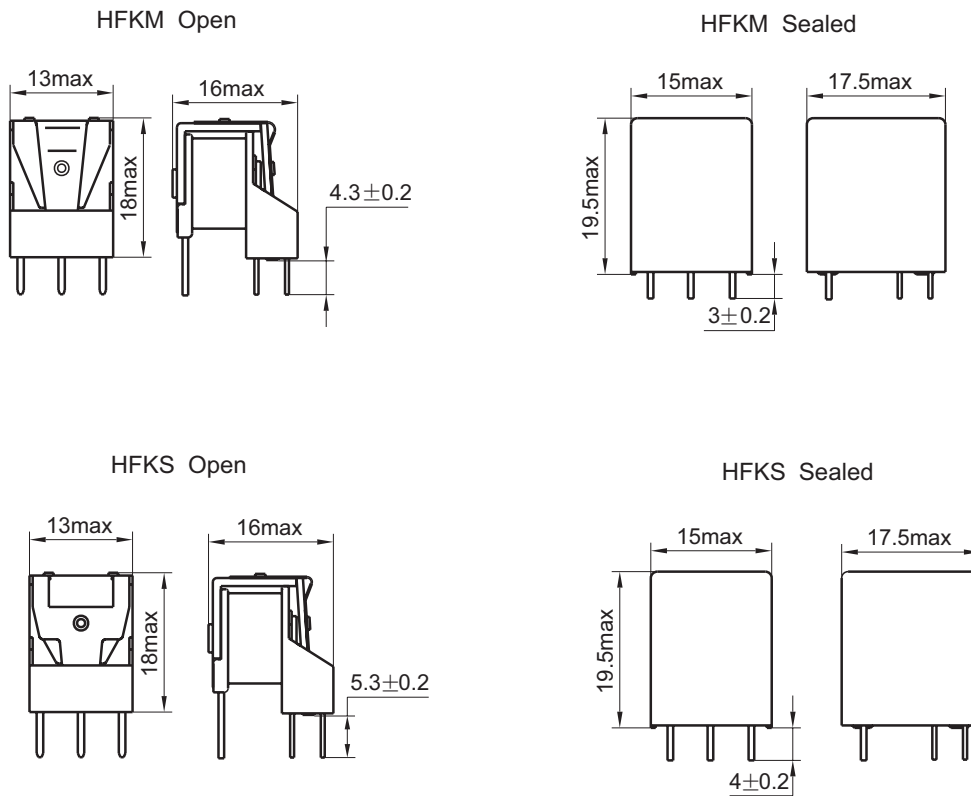

OUTLINE DIMENSIONS, WIRING DIAGRAM AND PC BOARD LAYOUT

Unit: mm

PCB Layout

HFKM/HFKS Open

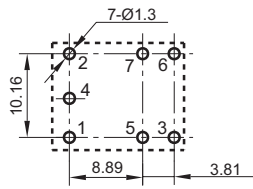

HFKM/HFKS Sealed

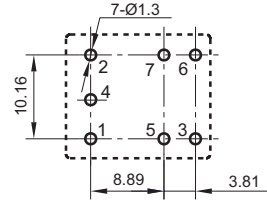

Remark: 1) In case of no tolerance shown in outline dimension: outline dimension $\leq 1\text{mm}$, tolerance should be $\pm 0.2\text{mm}$; outline dimension $> 1\text{mm}$ and $\leq 5\text{mm}$, tolerance should be $\pm 0.3\text{mm}$; outline dimension $> 5\text{mm}$, tolerance should be $\pm 0.4\text{mm}$.
2) The tolerance without indicating for PCB mounting holes is always $\pm 0.1\text{mm}$.

Wiring Diagram (Bottom view)

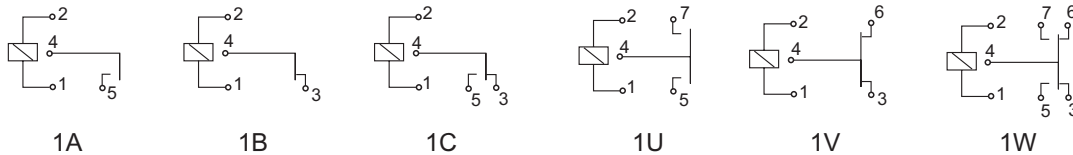

CHARACTERISTIC CURVES

1. Coil operating voltage range

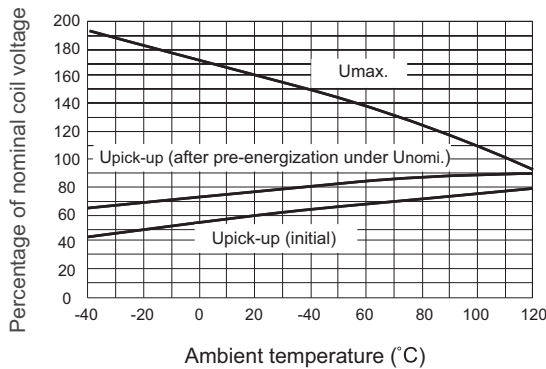

- 1) The operating voltage is connected with coil pre-energized time and voltage. After pre-energized, the operating voltage will increase.
- 2) The maximum allowable coil temperature is 155°C . For the coil temperature rise which is measured by resistance is average value, we recommend the coil temperature should be below 130°C under the different application ambient, different coil voltage and different load etc.
- 3) If the actual operating coil voltage is out of the specified range, please contact Hongfa for further details.

2. Load limit curve

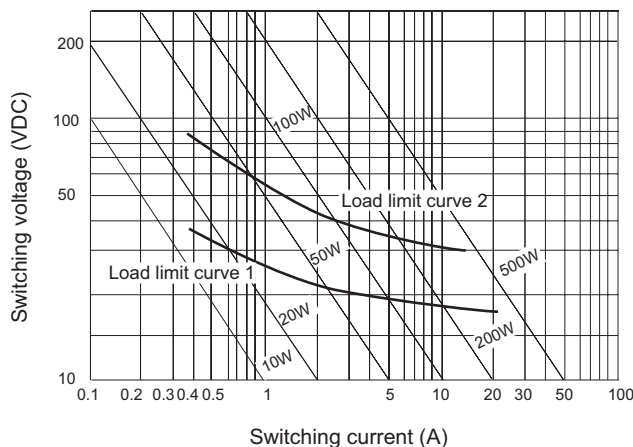

- 1) The load and electrical life tests are made according to "CONTACT DATA" parameters' table. If actual load voltage, current, or operate frequency is different from "CONTACT DATA" table, please arrange corresponding tests for confirmation.
- 2) Load limit curve 1: arc extinguishes, during transit time (change over contact).
- 3) Load limit curve 2: safe shutdown, no stationary arc (make contact)

CHARACTERISTIC CURVES

3. Application examples ¹⁾

Symbol	Relay type	Load type	On/Off ratio	Test temperature (°C)	Test time (h)
1	HFKM/012-1HST	Lamp: 3×21W	15s : 15s	70 40	80 320
2	HFKM/012-1HST	Lamp: 6×21W	15s : 15s	40	100
3	HFKM/012-SHST	Lamp: 2×10W Lamp: 3×15W	20s : 2s	40 40	500 500
4	HFKM/012-1ZST	Lamp: 2×21W	30s : 30s	85	850
5	HFKM/012-SHT (170)	Lamp: 2×21W+1×5W	500ms : 500ms	85	450

1) The actual capabilities of the relay can be higher than the example parameters.

Disclaimer

This datasheet is for the customers' reference. All the specifications are subject to change without notice.

We could not evaluate all the performance and all the parameters for every possible application. Thus the user should be in a right position to choose the suitable product for their own application. If there is any query, please contact Hongfa for the technical service. However, it is the user's responsibility to determine which product should be used only.

© 2005 Xiamen Hongfa Electroacoustic Co., Ltd. All rights of Hongfa are reserved.