

### KTIR0821DS

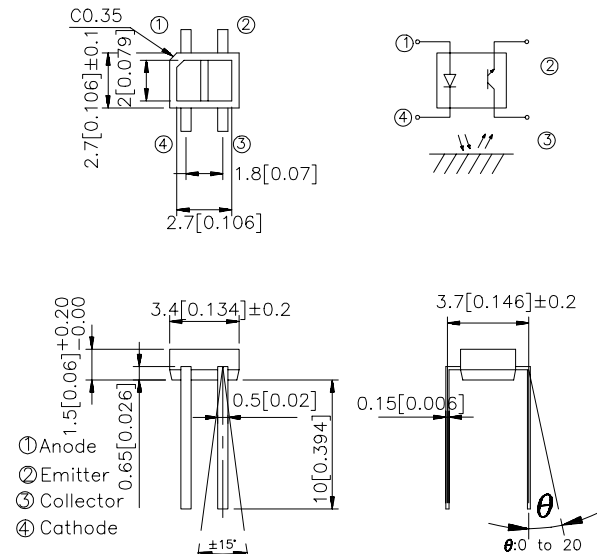
#### Features

- Compact and thin
- Visible light cut-off type
- High sensitivity

#### Applications

- Cassette tape recorders, VCRs
- Floppy disk drives
- Various microcomputerized control equipment

#### Package Dimensions



#### Notes:

1. All dimensions are in millimeters (inches).
2. Tolerance is  $\pm 0.25(0.01")$  unless otherwise noted.
3. Lead spacing is measured where the lead emerge package.
4. Specifications are subject to change without notice.

#### Absolute Maximum Ratings ( $T_a=25^\circ\text{C}$ )

Parameter		Symbol	Rating	Unit
Input	Forward current	$I_F$	50	mA
	Reverse voltage	$V_R$	5	V
	Power dissipation	P	75	mW
Output	Collector-emitter voltage	$V_{CEO}$	30	V
	Emitter-collector voltage	$V_{ECO}$	5	V
	Collector current	$I_C$	50	mA
	Collector power dissipation	$P_C$	75	mW
Operating temperature		$T_{opr}$	-25~+85	$^\circ\text{C}$
Storage temperature		$T_{stg}$	-40~+100	$^\circ\text{C}$
Soldering temperature (1/16 inch from body for 5 seconds)		$T_{sol}$	260	$^\circ\text{C}$

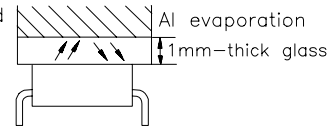
## Electro-optical Characteristics (T<sub>a</sub>=25°C)

Parameter		Symbol	Conditions	Min.	Typ.	Max.	Unit
Input	Forward voltage	V <sub>F</sub>	I <sub>F</sub> =20mA	—	1.2	1.5	V
	Reverse current	I <sub>R</sub>	V <sub>R</sub> =5V	—	—	10	μA
Output	Collector dark current	I <sub>CEO</sub>	V <sub>CE</sub> =10V, I <sub>F</sub> =0mA	—	—	10 <sup>-6</sup>	A
Transfer characteristics	*1 Collector current	I <sub>C</sub>	V <sub>CE</sub> =2V, I <sub>F</sub> =4mA	—	3	—	mA
	*2 Leak current	I <sub>LEAK</sub>	V <sub>CE</sub> =5V, I <sub>F</sub> =4mA	—	—	5	μA
	Response time	Rise time	t <sub>r</sub>	V <sub>CE</sub> =2V, I <sub>C</sub> =10mA R <sub>L</sub> =100Ω, d=1mm	—	80	400
Fall time		t <sub>f</sub>	—		70	400	μsec

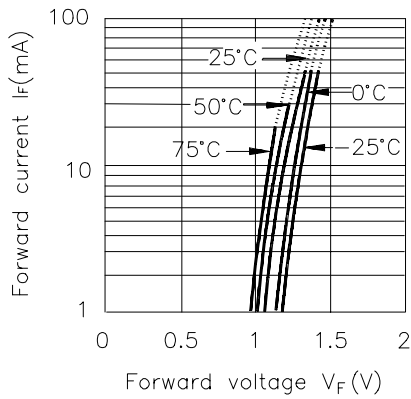
\*1 The condition and arrangement of the reflective object are shown below

\*2 Without reflective object

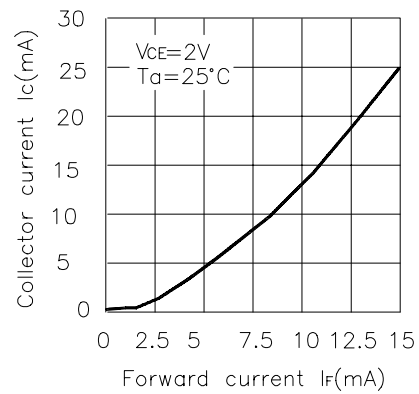
Test Condition and Arrangement for Collector Current



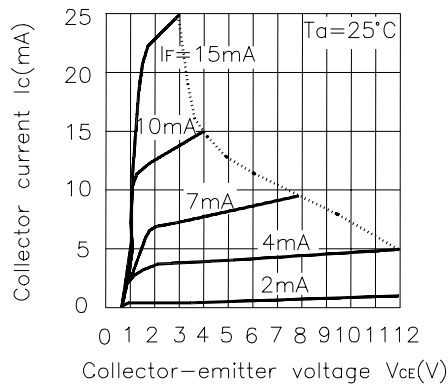
**Fig.1 Forward Current vs. Forward Voltage**



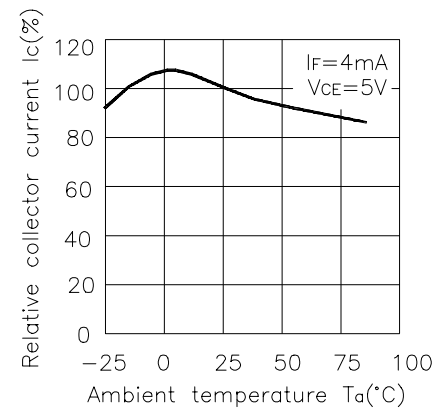
**Fig.2 Collector Current vs. Forward Current**



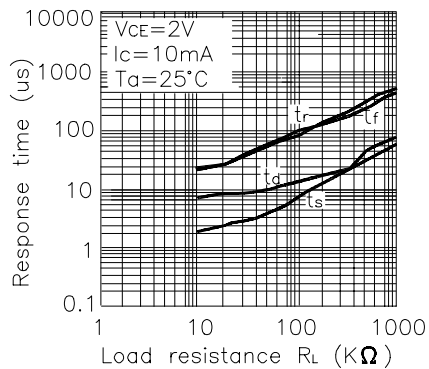
**Fig.3 Collector Current vs. Collector-emitter Voltage**



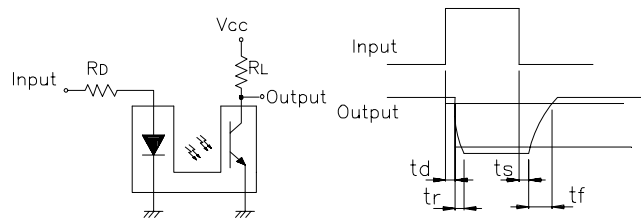
**Fig.4 Relative Collector Current vs. Ambient Temperature**



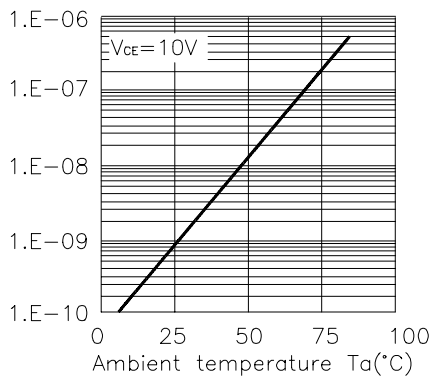
**Fig.5 Response Time vs Load Resistance**



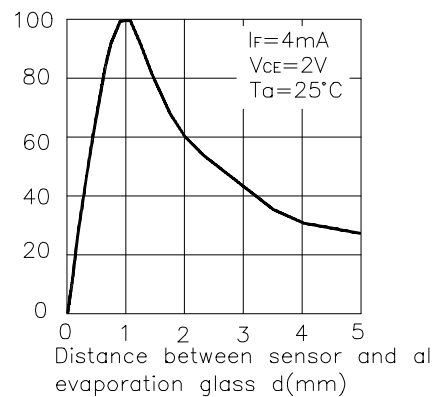
**Test Circuit for Response Time**



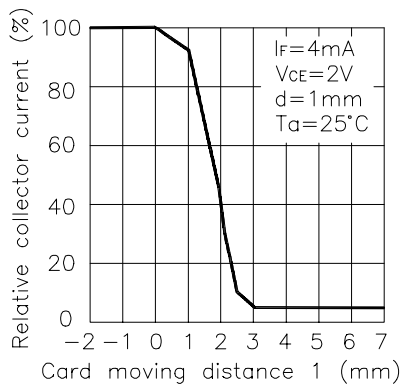
**Fig.6 Collector Dark Current vs Ambient Temperature**



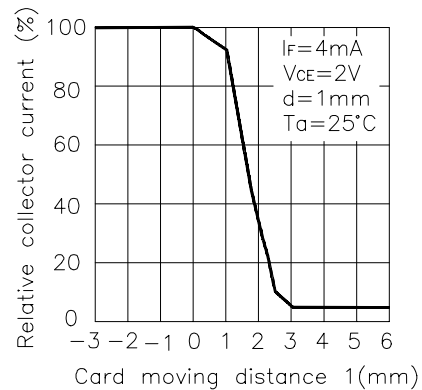
**Fig.7 Relative Collector Current vs Distance between Sensor and Al Evaporation Glass**



**Fig.8 Relative Collector Current vs. Card Moving Distance (1)**

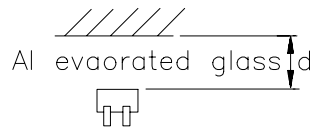


**Fig.9 Relative Collector Current vs. Card Moving Distance (2)**



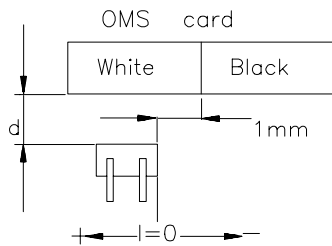
## The Condition for Distance&Detecting Position Characteristics

Correpond to Fig.7



Correpond to Fig.8  
Test condition

$I_F = 4\text{mA}$   
 $V_{CE} = 2\text{V}$   
 $d = 1\text{mm}$



Correpond to Fig.9  
Test condition

$I_F = 4\text{mA}$   
 $V_{CE} = 2\text{V}$   
 $d = 1\text{mm}$

