

## ADVANCE INFORMATION

### STEREO AF AMPLIFIER

The TEA2024 is an A.F. stereo amplifier in plastic package of 10 passages which is especially adapted for use in radio-cassette and low cost car-radio.

It has the capacity to supply an output power of 3.5 W per channel in the following conditions :  $V_{CC} = 12 V$ ,  $THD = 10 \%$ ,  $R_L = 4 \Omega$ .

- Low idle current
- Internal thermal protection
- Protection against short-circuit
- Single-in-line package
- Very few external components
- Excellent ripple rejection.

### STEREO AF AMPLIFIER

#### CASE CB-313

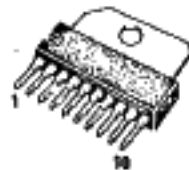

SP SUFFIX  
PLASTIC PACKAGE

### TYPICAL APPLICATION DUAL MODE

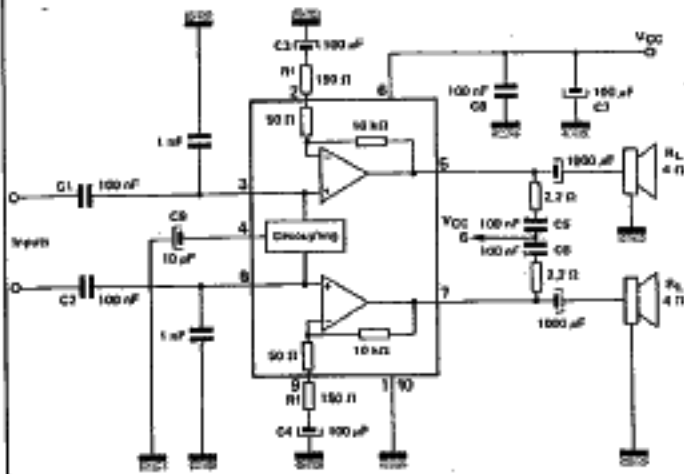

### PIN ASSIGNMENT

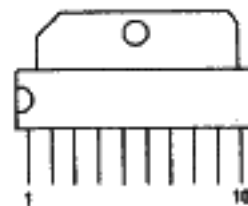

1. Ground (1)
2. Feedback (1)
3. Positive Input (1)
4. Decoupling
5. Output (1)
6. VCC (1)
7. Output (2)
8. Positive Input (2)
9. Feedback (2)
10. Ground (2)

T-74-05-01

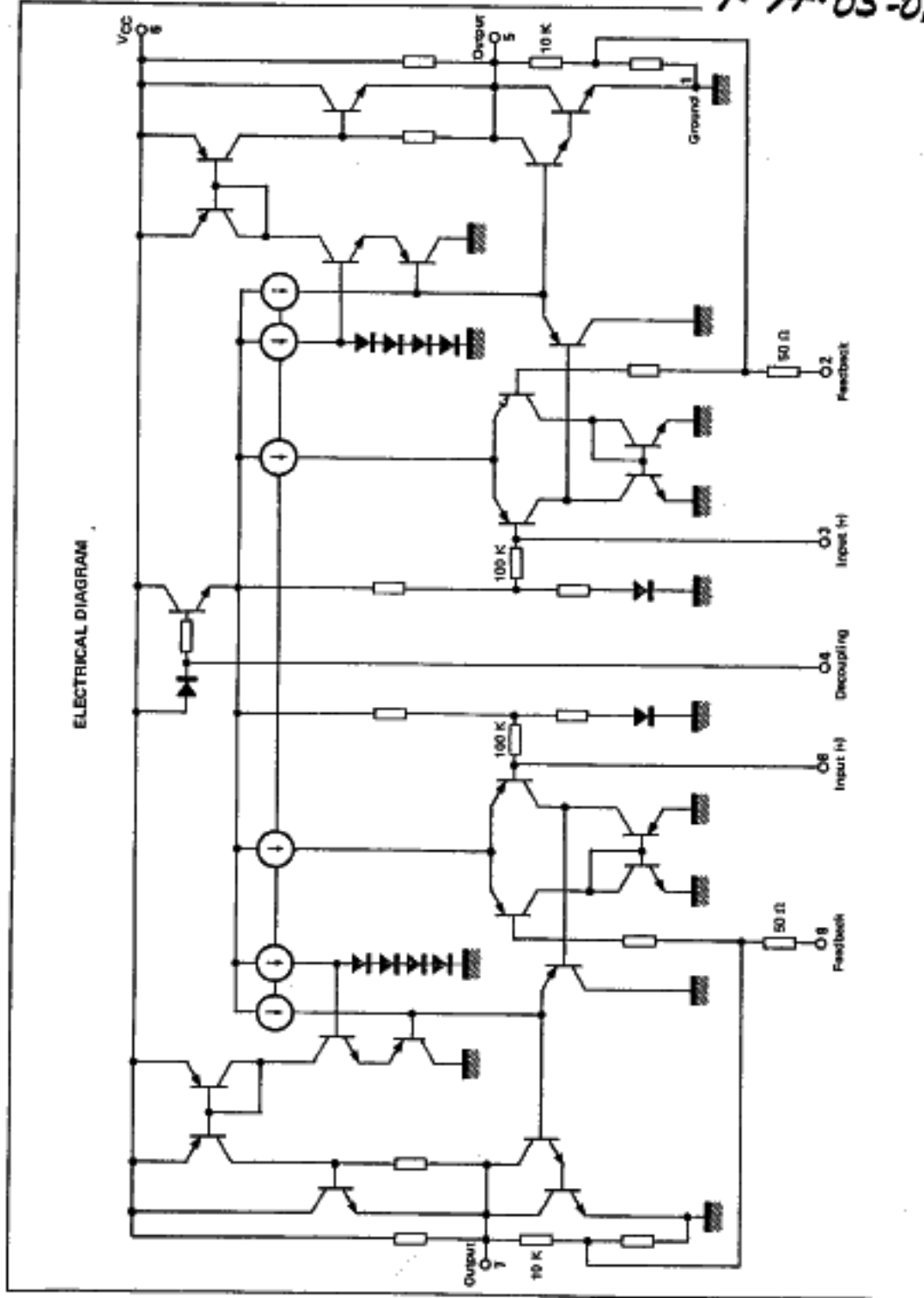

ELECTRICAL DIAGRAM

T-74-05-01

## MAXIMUM RATINGS

Rating	Symbol	Value	Unit
Supply voltage	$V_{CC}$	20	V
Operating supply voltage	$V_{CC}$	18	V
Power dissipation	$P_{out}$	See graphs	
Maximum output current	$I_O$	2.5	A
Storage or junction temperature	$T_{stg}, T_j$	-40, +150	$^{\circ}C$

## THERMAL CHARACTERISTICS

Characteristic	Symbol	Value	Unit
Junction-ambient thermal resistance	$R_{\theta(j-a)}$	60	$^{\circ}C/W$
Junction-case thermal resistance	$R_{\theta(j-c)}$	9	$^{\circ}C/W$

## ELECTRICAL CHARACTERISTICS

$V_{CC} = 12\text{ V}$ ,  $T_{amb} = +25^{\circ}C$ ,  $R_L = 4\ \Omega$ ,  $A_V = 46\text{ dB}$ , Dual mode (unless otherwise specified)

Characteristic	Symbol	Min	Typ	Max	Unit
Supply voltage range	$V_{CC}$	6	-	18	V
Supply current ( $V_G = 0$ )	$I_{CC}$	-	35	60	mA
D.C. output voltage ( $V_{CC} = 12\text{ V}$ )	$V_{out}$	5.4	6.0	6.6	V
Output power ( $f = 1\text{ kHz}$ ; $d = 10\%$ ; $R_L = 4\ \Omega$ )	$P_{out}$				W
Dual mode - per channel					
$V_{CC} = 12\text{ V}$		3	3.5	-	
$V_{CC} = 9\text{ V}$		-	1.75	-	
$V_{CC} = 6\text{ V}$		-	0.60	-	
$V_{CC} = 14.4\text{ V}$		-	5	-	
BTL mode - $V_{CC} = 12\text{ V}$		-	10	-	
Voltage gain without external resistance					dB
$R_f = 100\ \Omega$	$A_{V1}$	31	34	37	
$R_f = 0\ \Omega$	$A_{V2}$	-	46	-	
Distortion ( $f = 1\text{ kHz}$ ; $V_{CC} = 12\text{ V}$ ; $R_L = 4\ \Omega$ ; $P_{out} = 0.5\text{ to }2\text{ W}$ )	$d$	-	0.3	1.5	%
Input noise voltage ( $R_G = 0$ ; $B = 20\text{ kHz}$ )		-	2	-	$\mu V$
Supply voltage ripple rejection	SVR				dB
Fripple = 100 Hz; $V_{ripple} = 0.5V_{RMS}$ ; $R_G = 0$		40	50	-	
Crosstalk ( $f = 1\text{ kHz}$ ; $R_G = 10\text{ K}$ )	CT	40	52	-	dB
Frequency response (3 dB) - ( $P_{out} = 1\text{ W}$ ; $R_L = 4\ \Omega$ )	B	-	0.015 - 40	-	KHz
Open loop gain		-	80	-	dB

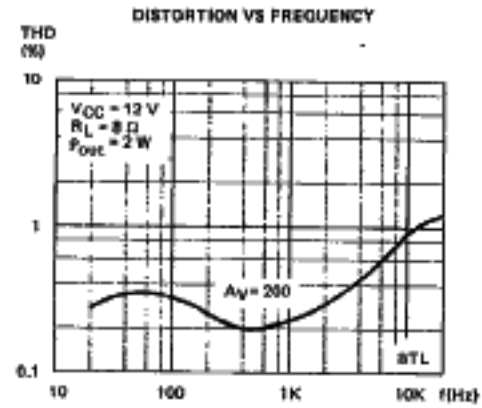
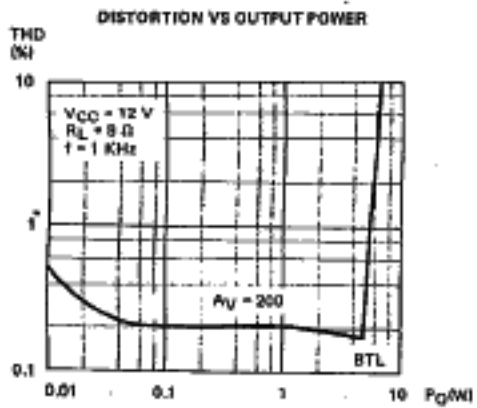
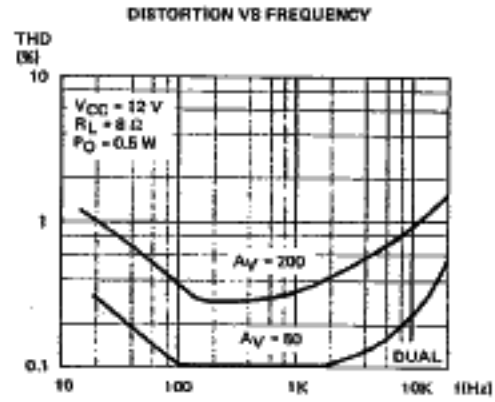
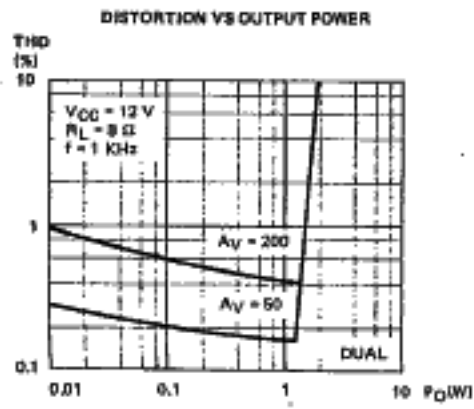
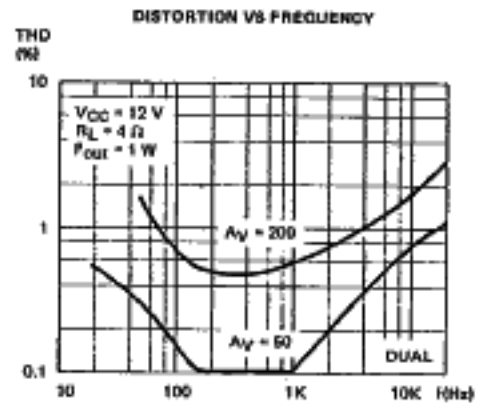
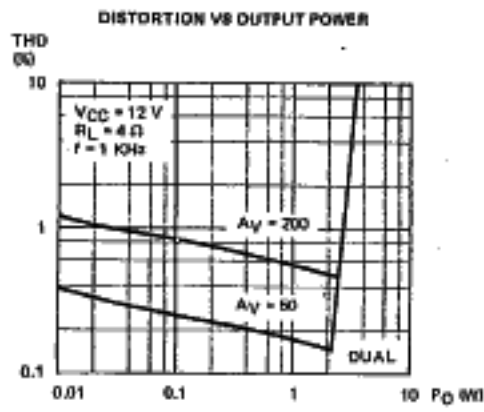

T-74-05-01

CROSSTALK VS FREQUENCY

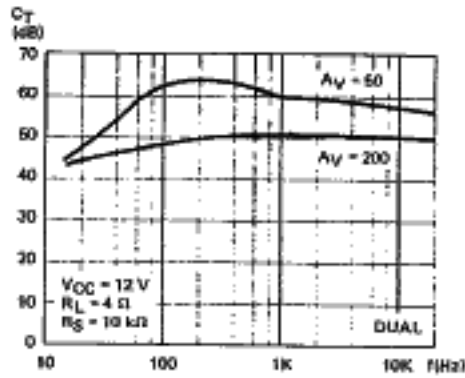

SUPPLY VOLTAGE RIPPLE REJECTION VS FREQUENCY

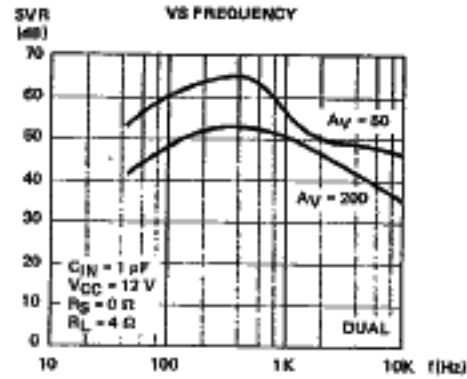

TOTAL DISSIPATED POWER VS OUTPUT POWER

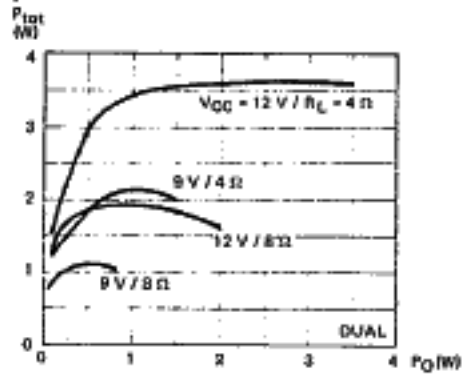

OUTPUT POWER VS SUPPLY VOLTAGE

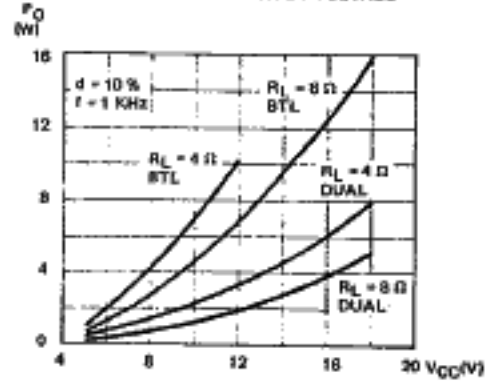

SUPPLY VOLTAGE RIPPLE REJECTION VS FREQUENCY

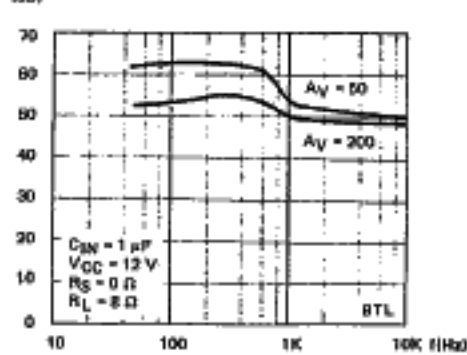

TOTAL DISSIPATED POWER VS OUTPUT POWER

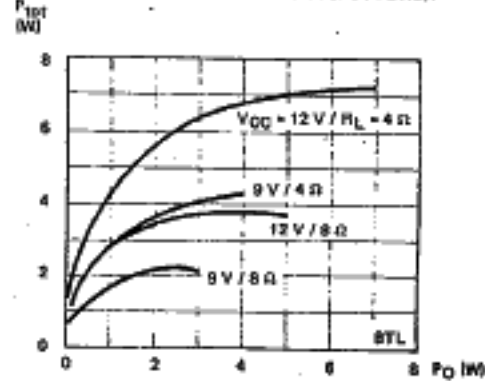

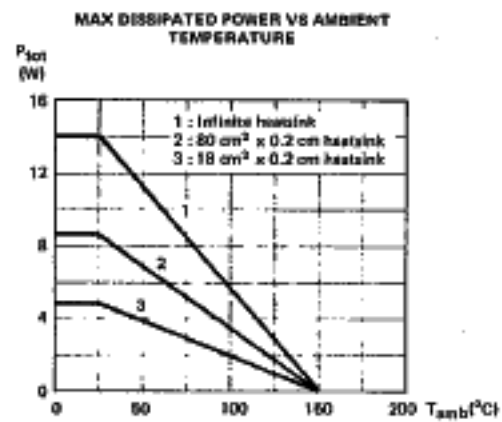
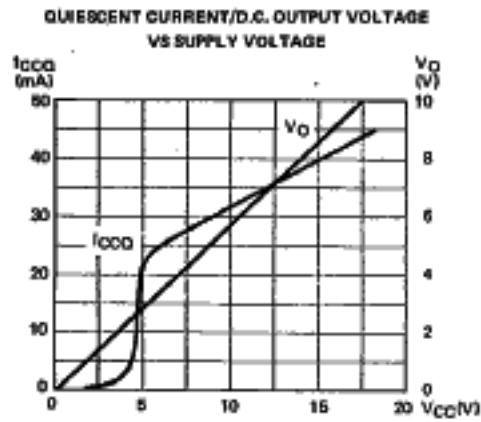

## BRIDGE MODE

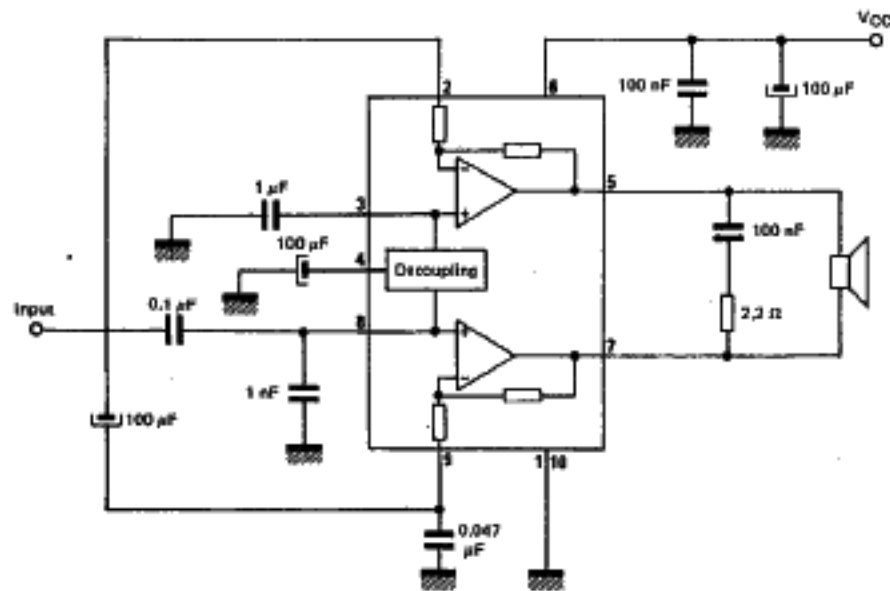

## APPLICATION INFORMATION

T-74-05-01

**GROUND CONNECTION**

Two ground pins are provided and must be connected together on the PC board. The GND connections for power - return from the load and negative supply - must be kept separated from the signal and feed-back ground. Inappropriate ground connections will cause parasitic oscillation, distortion and cross-talk.

**VOLTAGE GAIN**

The voltage gain is determined by the ratio of internal

feedback resistors and external resistor  $R_f$ .

$$G_v = 34 \text{ dB for } R_f = 150 \Omega$$

$$G_v = 45 \text{ dB for } R_f = 0 \Omega$$

**CAPACITORS C5 AND C6**

These capacitors must be connected close to the I.C. connections. Low temp-coefficient type will give the best results to prevent oscillations.

1 nF ceramic capacitors bypassing inputs to ground will help prevent high oscillations or radio interference.

OUTPUT POWER TABLE (TYPICAL VALUE)					
THD = 10% ; f = 1 KHz ; T <sub>amb</sub> = + 25°C					
LOAD	VCC	6 V	9 V	12 V	14.4 V
	DUAL	8 Ω	—	1 W/ch	1.8 W/ch
4 Ω		0.8 W/ch	1.8 W/ch	3.5 W/ch	6 W/ch
BTL	8 Ω	1.2 W	3.5 W	6.7 W	10.5 W
	4 Ω	2.0 W	6.3 W	10 W	—

DUAL and BTL MODES  
PRINTED CIRCUIT BOARD

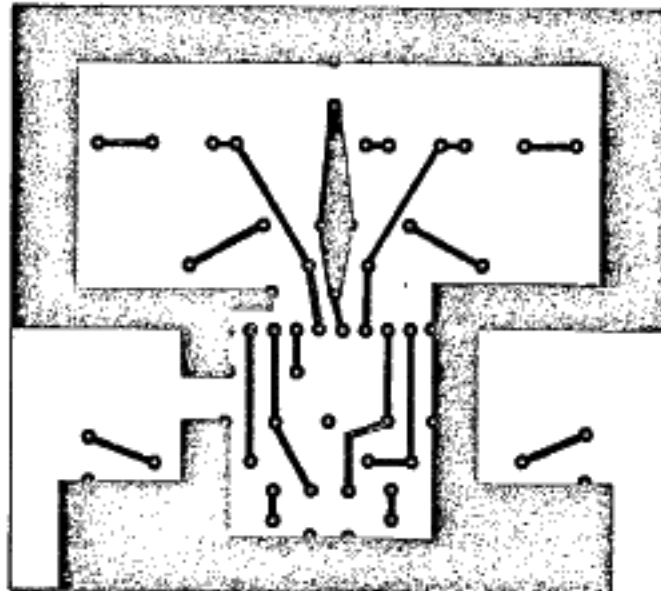



T-74-05-01

## COMPONENT LAYOUT (DUAL MODE)

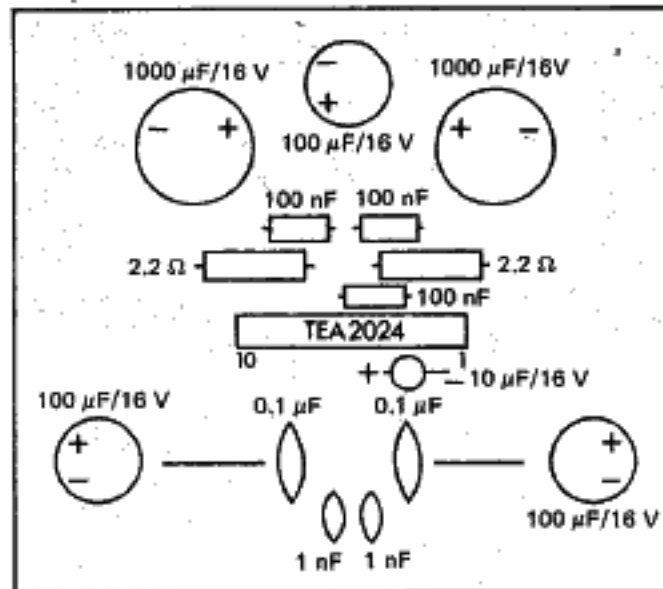

## COMPONENT LAYOUT (BRIDGE MODE)

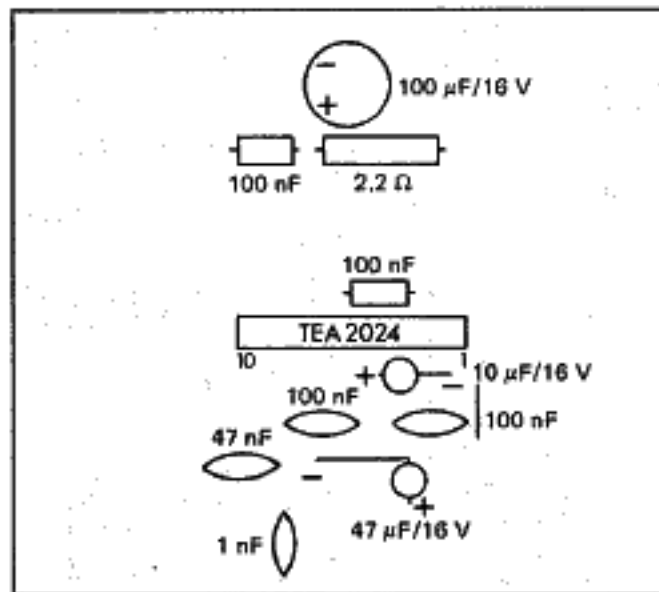

T-74-05-01

## CASE CB-313

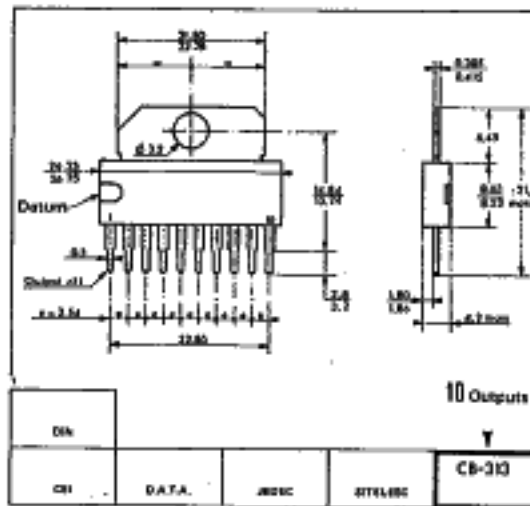
SP SUFFIX  
PLASTIC PACKAGE

This is advance information and specifications are subject to change without notice.  
Please inquire with our sales offices about the availability of the different packages.