

Dual, 1MHz, Operational Amplifiers for Commercial Industrial, and Military Applications

The CA158, CA158A, CA258, CA358, CA358A and CA2904 types consist of two independent, high gain, internally frequency compensated operational amplifiers which are designed specifically to operate from a single power supply over a wide range of voltages. They may also be operated from split power supplies. The supply current is basically independent of the supply voltage over the recommended voltage range.

These devices are particularly useful in interface circuits with digital systems and can be operated from the single common 5VDC power supply. They are also intended for transducer amplifiers, DC gain blocks and many other conventional op amp circuits which can benefit from the single power supply capability.

The CA158, CA158A, CA258, CA358, CA358A, and CA2904 types are an equivalent to or a replacement for the industry types 158, 158A, 258, 258A, 358, 358A, and CA2904.

Technical Data on LM Branded types is identical to the corresponding CA Branded types.

Pinouts

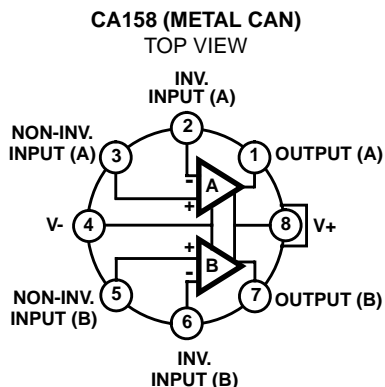

**CA158, CA258, CA358 (PDIP, SOIC)
CA2904, LM358, LM2904 (PDIP)
TOP VIEW**

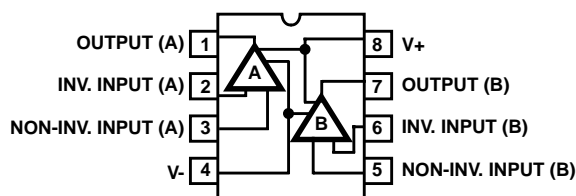

Features

- Internal Frequency Compensation for Unity Gain
- High DC Voltage Gain 100dB (Typ)
- Wide Bandwidth at Unity Gain 1MHz (Typ)
- Wide Power Supply Range:
 - Single Supply 3V to 30V
- Dual Supplies ±1.5V to ±15V
- Low Supply Current 1.5 mA (Typ)
- Low Input Bias Current
- Low Input Offset Voltage and Current
- Input Common-Mode Voltage Range Includes Ground
- Differential Input Voltage Range Equal to V+ Range
- Large Output Voltage Swing. 0V to V+ -1.5V

Ordering Information

PART NUMBER	TEMP. RANGE (°C)	PACKAGE	PKG. NO.
CA0158E	-55 to 125	8 Ld PDIP	E8.3
CA0158AE	-55 to 125	8 Ld PDIP	E8.3
CA0158M	-55 to 125	8 Ld SOIC	M8.15
CA0158T	-55 to 125	8 Pin Can	T8.C
CA0258E	-25 to 85	8 Ld PDIP	E8.3
CA0258M	-25 to 85	8 Ld SOIC	M8.15
CA0358E	0 to 70	8 Ld PDIP	E8.3
CA0358AE	0 to 70	8 Ld PDIP	E8.3
CA0358M	0 to 70	8 Ld SOIC	M8.15
CA2904E	-40 to 85	8 Ld PDIP	E8.3
LM358N	0 to 70	8 Ld PDIP	E8.3
LM2904N	-40 to 85	8 Ld PDIP	E8.3

CA158, CA158A, CA258, CA258A, CA358, CA358A, CA2904, LM358, LM2904

Absolute Maximum Ratings

Supply Voltage	
CA2904, LM2904	26V or $\pm 13V$
Other Types	32V or $\pm 16V$
Differential Input Voltage (All Types)	32V
Input Voltage	-0.3V to $V+$
Input Current ($V_I < -0.3V$, Note 1)	50mA
Output Short Circuit Duration ($V+ \leq 15V$, Note 2)	Continuous

Operating Conditions

Temperature Range	
CA158, CA158A	-55°C to 125°C
CA258	-25°C to 85°C
CA2904, LM2904	-40°C to 85°C
CA358, CA358A, LM358	0°C to 70°C

CAUTION: Stresses above those listed in "Absolute Maximum Ratings" may cause permanent damage to the device. This is a stress only rating and operation of the device at these or any other conditions above those indicated in the operational sections of this specification is not implied.

NOTES:

1. This input current will only exist when the voltage at any of the input leads is driven negative. This current is due to the collector base junction of the input PNP transistors becoming forward biased and thereby acting as input diode clamps. In addition to this diode action, there is also lateral NPN parasitic transistor action on the IC chip. This transistor action can cause the output voltages of the amplifiers to go to the $V+$ voltage level (or to ground for a large overdrive) for the time duration that an input is driven negative. This transistor action is not destructive and normal output states will re-establish when the input voltage, which was negative, again returns to a value greater than -0.3V.
2. The maximum output current is approximately 40mA independent of the magnitude of $V+$. Continuous short circuits at $V+ > 15V$ can cause excessive power dissipation and eventual destruction. Short circuits from the output to $V+$ can cause overheating and eventual destruction of the device. Destructive dissipation can result from simultaneous short circuits on both amplifiers.
3. θ_{JA} is measured with the component mounted on an evaluation PC board in free air.

Electrical Specifications

Values Apply for Each Operational Amplifier. Supply Voltage $V+ = 5V$, $V- = 0V$, Unless Otherwise Specified

PARAMETER	TEST CONDITIONS	TEMP (°C)	CA158A			CA358A			UNITS
			MIN	TYP	MAX	MIN	TYP	MAX	
Input Offset Voltage (Note 6)		25	-	1	2	-	2	3	mV
		Full	-	-	4	-	-	5	mV
Average Input Offset Voltage Drift	$R_S = 0\Omega$	Full	-	7	15	-	7	20	$\mu V/^\circ C$
Input Common Mode Voltage Range (Note 5)	$V+ = 30V$	25	0	-	$V+ - 1.5$	0	-	$V+ - 1.5$	V
	$V+ = 30V$	Full	0	-	$V+ - 2$	0	-	$V+ - 2$	V
Common Mode Rejection Ratio	DC	25	70	85	-	65	85	-	dB
Power Supply Rejection Ratio	DC	25	65	100	-	65	100	-	dB
Input Bias Current (Note 4)	I_{I+} or I_{I-}	25	-	20	50	-	45	100	nA
	I_{I+} or I_{I-}	Full	-	40	100	-	40	200	nA
Input Offset Current	$I_{I+} - I_{I-}$	25	-	2	10	-	5	30	nA
	$I_{I+} - I_{I-}$	Full	-	-	30	-	-	75	nA
Average Input Offset Current Drift		Full	-	10	200	-	10	300	$pA/^\circ C$
Large Signal Voltage Gain	$R_L \geq 2k\Omega$, $V+ = 15V$ (For Large V_O Swing)	25	50	100	-	25	100	-	kV/V
Output Voltage Swing	$R_L = 2k\Omega$	25	0	-	$V+ - 1.5$	0	-	$V+ - 1.5$	V

CA158, CA158A, CA258, CA258A, CA358, CA358A, CA2904, LM358, LM2904

Electrical Specifications Values Apply for Each Operational Amplifier. Supply Voltage $V_+ = 5V$, $V_- = 0V$, Unless Otherwise Specified **(Continued)**

PARAMETER	TEST CONDITIONS	TEMP (°C)	CA158A			CA358A			UNITS	
			MIN	TYP	MAX	MIN	TYP	MAX		
Output Current	Source	$V_{I+} = +1V$, $V_{I-} = 0V$, $V_+ = 15V$	25	20	40	-	20	40	-	mA
	Sink	$V_{I+} = 0V$, $V_{I-} = 1V$, $V_+ = 15V$	25	10	20	-	10	20	-	mA
		$V_{I+} = 0V$, $V_{I-} = 1V$, $V_O = 200mV$	25	12	50	-	12	50	-	μA
Short Circuit Output Current (Note 2)	$R_L = 0\Omega$	25	-	40	60	-	40	60	mA	
Crosstalk	$f = 1$ to 20kHz (Input Referred)	25	-	-120	-	-	-120	-	dB	
Total Supply Current	$R_L = \infty$	Full	-	0.7	1.2	-	0.7	1.2	mA	
	$R_L = \infty$, $V_+ = 30V$	Full	-	1.5	3	-	1.5	3	mA	

NOTES:

- Due to the PNP input stage the direction of the input current is out of the IC. No loading change exists on the input lines because the current is essentially constant, independent of the state of the output.
- The input signal voltage and the input common mode voltage should not be allowed to go negative by more than 0.3V. The positive limit of the common mode voltage range is $V_+ - 1.5V$, but either or both inputs can go to +32V without damage.
- $V_O = 1.4V$, $R_S = 0\Omega$ with V_+ from 5V to 30V, and over the full input common mode voltage range (0V to $V_+ - 1.5V$).

Electrical Specifications Values Apply for Each Operational Amplifier. Supply Voltage $V_+ = 5V$, $V_- = 0V$, Unless Otherwise Specified

PARAMETER	TEST CONDITIONS	TEMP (°C)	CA158, CA258			CA358, LM358			CA2904, LM2904			UNITS
			MIN	TYP	MAX	MIN	TYP	MAX	MIN	TYP	MAX	
Input Offset Voltage (Note 9)		25	-	2	5	-	2	7	-	2	7	mV
		Full	-	-	7	-	-	9	-	-	10	mV
Average Input Offset Voltage Drift	$R_S = 0\Omega$	Full	-	7	-	-	7	-	-	7	-	$\mu V/^\circ C$
Input Common Mode Voltage Range (Note 8)	$V_+ = 30V$	25	0	-	$V_+ - 1.5$	0	-	$V_+ - 1.5$	0	-	$V_+ - 1.5$	V
	$V_+ = 30V$	Full	0	-	$V_+ - 2$	0	-	$V_+ - 2$	0	-	$V_+ - 2$	V
Common Mode Rejection Ratio	DC	25	70	85	-	65	70	-	50	70	-	dB
Power Supply Rejection Ratio	DC	25	65	100	-	65	100	-	50	100	-	dB
Input Bias Current (Note 7)	I_{I+} or I_{I-}	25	-	45	150	-	45	250	-	45	250	nA
	I_{I+} or I_{I-}	Full	-	40	300	-	40	500	-	40	500	nA
Input Offset Current	$I_{I+} - I_{I-}$	25	-	3	30	-	5	50	-	5	50	nA
	$I_{I+} - I_{I-}$	Full	-	-	100	-	-	150	-	45	200	nA
Average Input Offset Current Drift		Full	-	10	-	-	10	-	-	10	-	$\mu A/^\circ C$
Large Signal Voltage Gain	$R_L \geq 2k\Omega$, $V_+ = 15V$ (For Large V_O Swing)	25	50	100	-	25	100	-	-	100	-	kV/V
Output Voltage Swing	$R_L = 2k\Omega$	25	0	-	$V_+ - 1.5$	0	-	$V_+ - 1.5$	0	-	$V_+ - 1.5$	V

CA158, CA158A, CA258, CA258A, CA358, CA358A, CA2904, LM358, LM2904

Electrical Specifications Values Apply for Each Operational Amplifier. Supply Voltage $V_+ = 5V$, $V_- = 0V$, Unless Otherwise Specified **(Continued)**

PARAMETER	TEST CONDITIONS	TEMP (°C)	CA158, CA258			CA358, LM358			CA2904, LM2904			UNITS	
			MIN	TYP	MAX	MIN	TYP	MAX	MIN	TYP	MAX		
Output Current	Source	$V_{I+} = +1V$, $V_{I-} = 0V$, $V_+ = 15V$	25	20	40	-	20	40	-	20	40	-	mA
	Sink	$V_{I+} = 0V$, $V_{I-} = 1V$, $V_+ = 15V$	25	10	20	-	10	20	-	10	20	-	mA
		$V_{I+} = 0V$, $V_{I-} = 1V$, $V_O = 200mV$	25	12	50	-	12	50	-	-	-	-	μA
Short Circuit Output Current (Note 2)	$R_L = 0\Omega$	25	-	40	60	-	40	60	-	40	60	mA	
Crosstalk	$f = 1$ to $20kHz$ (Input Referred)	25	-	-120	-	-	-120	-	-	-120	-	dB	
Total Supply Current	$R_L = \infty$	Full	-	0.7	1.2	-	0.7	1.2	-	0.7	1.2	mA	
	$R_L = \infty$, $V_+ = 30V$	Full	-	1.5	3	-	1.5	3	-	1.5	3	mA	

NOTES:

- Due to the PNP input stage the direction of the input current is out of the IC. No loading change exists on the input lines because the current is essentially constant, independent of the state of the output.
- The input signal voltage and the input common mode voltage should not be allowed to go negative by more than 0.3V. The positive limit of the common mode voltage range is $V_+ - 1.5V$, but either or both inputs can go to $+32V$ without damage.
- $V_O = 1.4V$, $R_S = 0\Omega$ with V_+ from 5V to 30V, and over the full input common mode voltage range (0V to $V_+ - 1.5V$).

Schematic Diagram

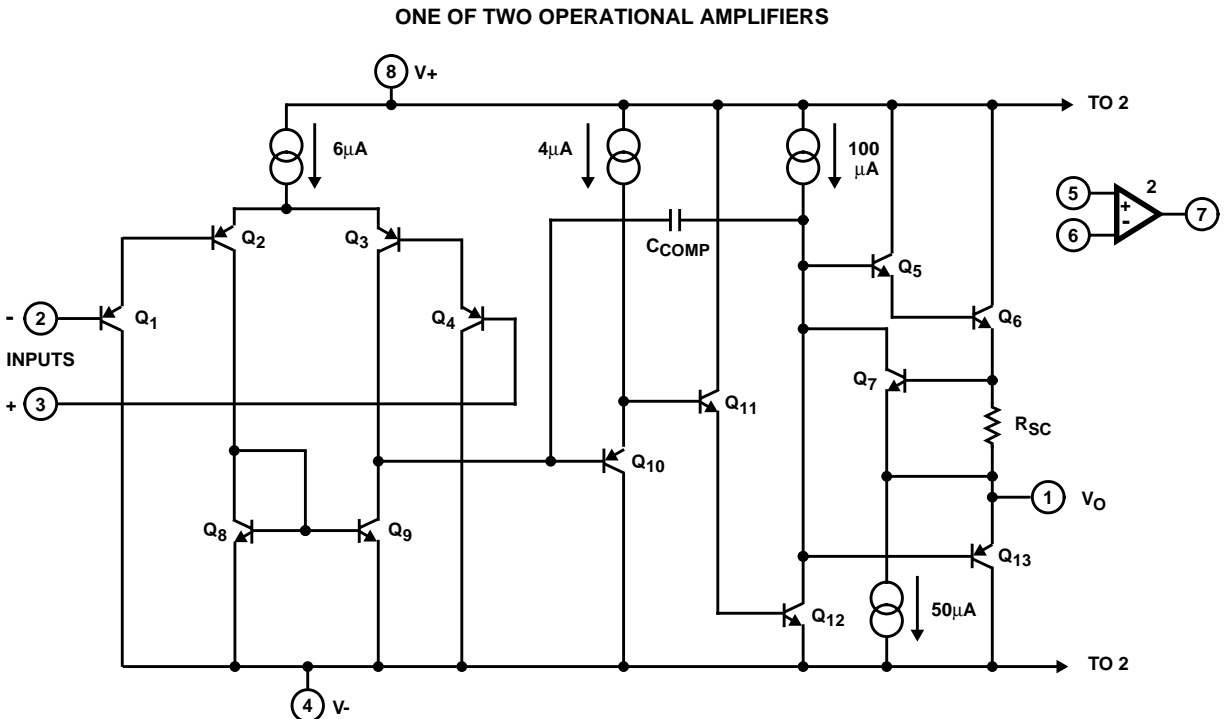

Typical Performance Curves

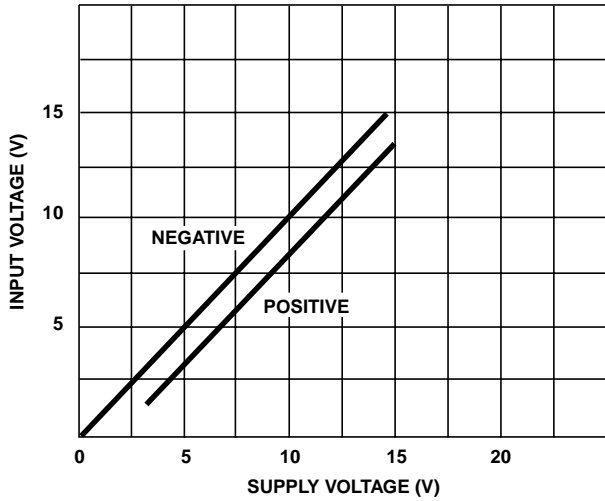

FIGURE 1. INPUT VOLTAGE RANGE vs SUPPLY VOLTAGE

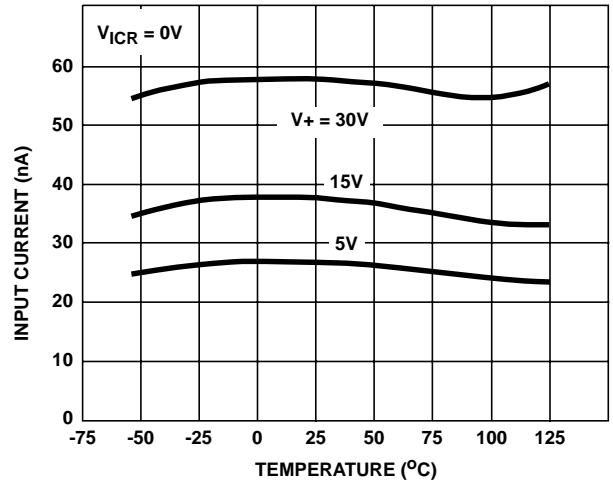

FIGURE 2. INPUT CURRENT vs AMBIENT TEMPERATURE

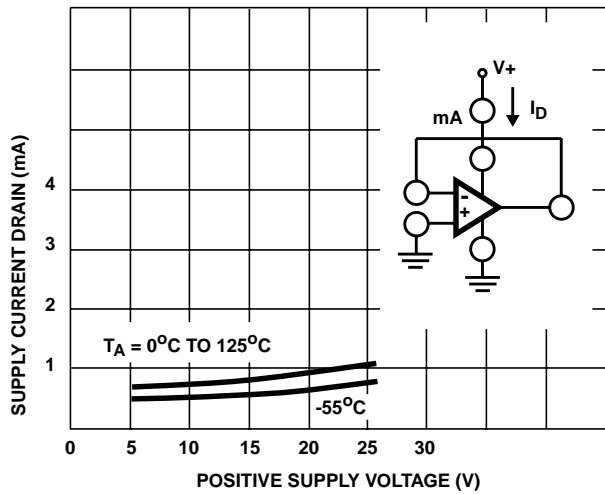

FIGURE 3. SUPPLY CURRENT DRAIN vs SUPPLY VOLTAGE

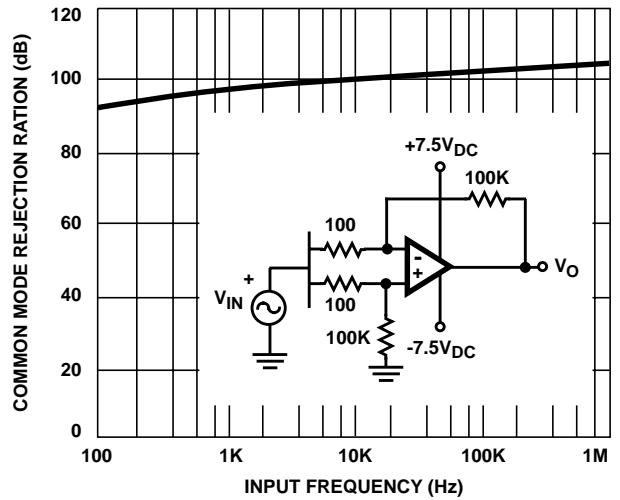

FIGURE 4. COMMON MODE REJECTION RATIO vs INPUT FREQUENCY

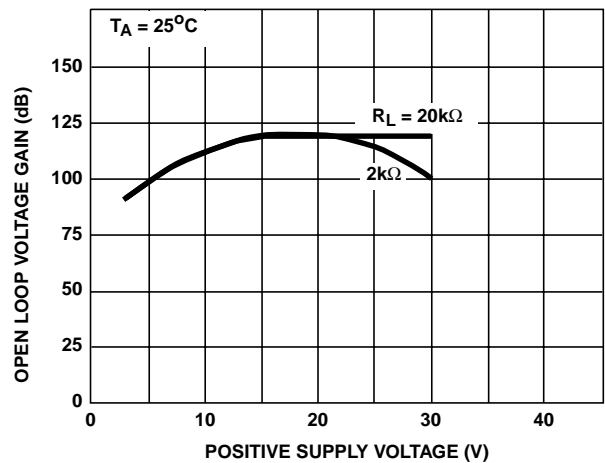

FIGURE 5. VOLTAGE GAIN vs SUPPLY VOLTAGE

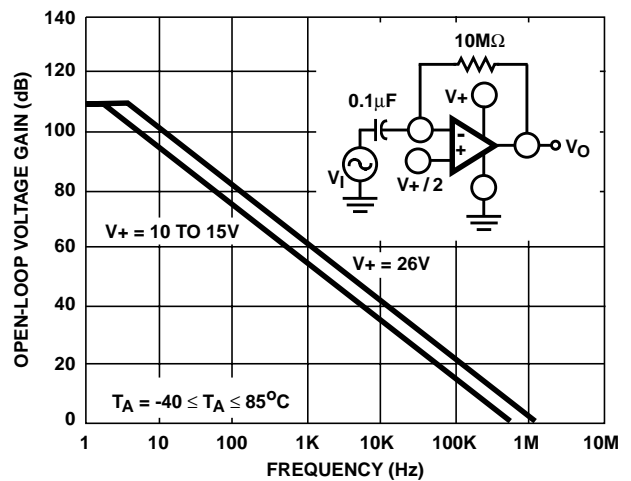

FIGURE 6. OPEN-LOOP FREQUENCY RESPONSE

Typical Performance Curves (Continued)

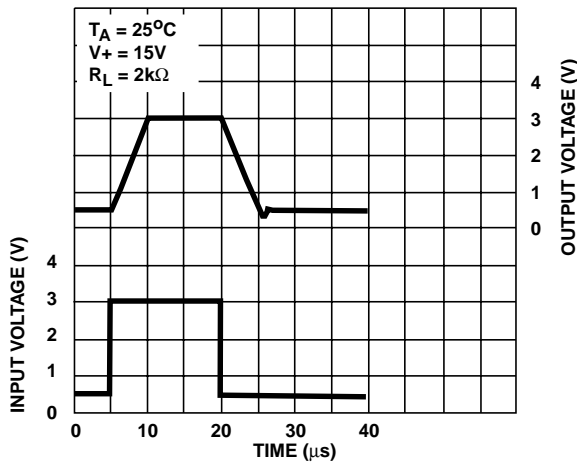

FIGURE 7. VOLTAGE FOLLOWER PULSE RESPONSE (LARGE SIGNAL)

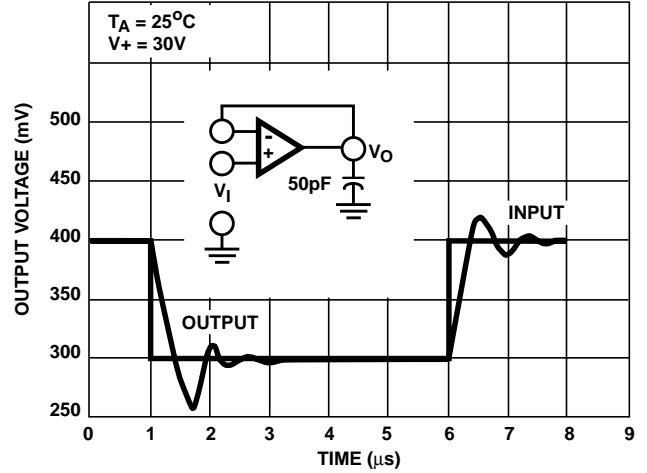

FIGURE 8. VOLTAGE FOLLOWER PULSE RESPONSE (SMALL SIGNAL)

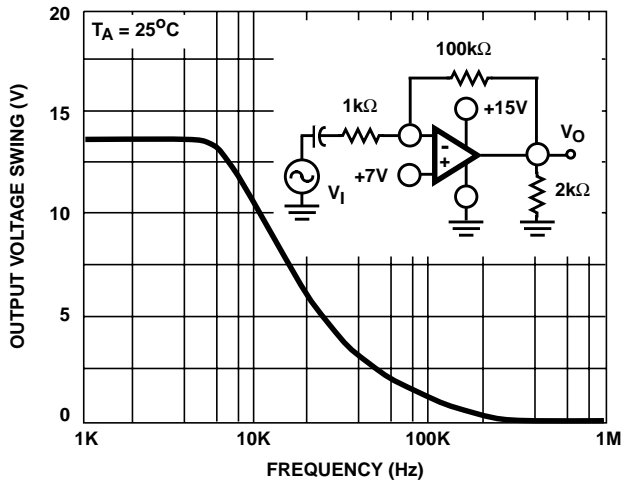

FIGURE 9. LARGE-SIGNAL FREQUENCY RESPONSE

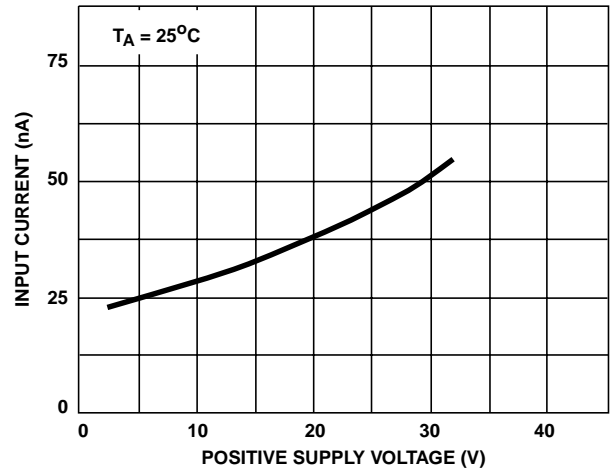

FIGURE 10. INPUT CURRENT vs SUPPLY VOLTAGE

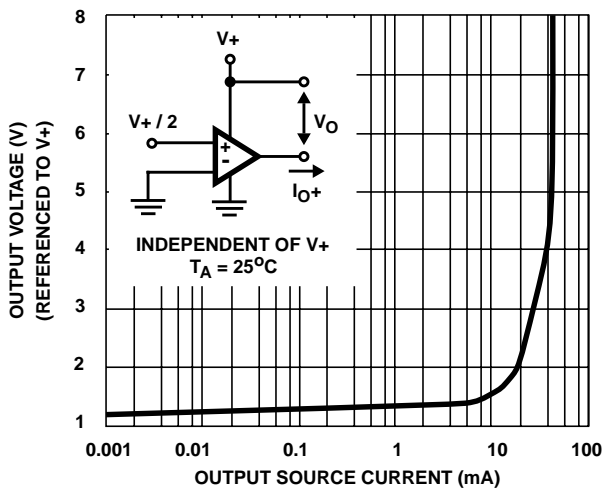

FIGURE 11. OUTPUT SOURCE CURRENT CHARACTERISTICS

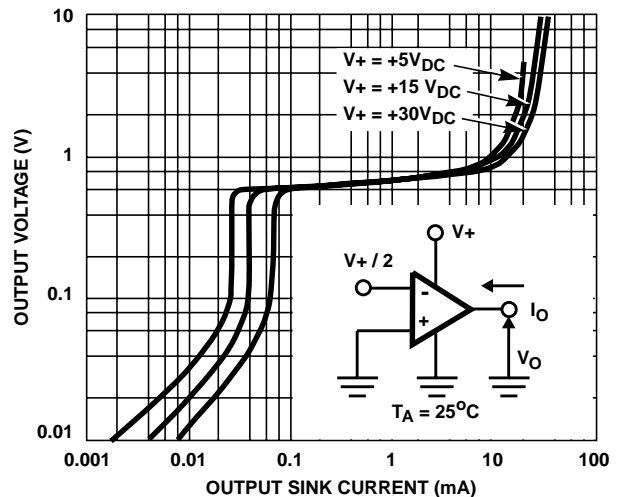

FIGURE 12. OUTPUT SINK CURRENT CHARACTERISTICS

Typical Performance Curves (Continued)

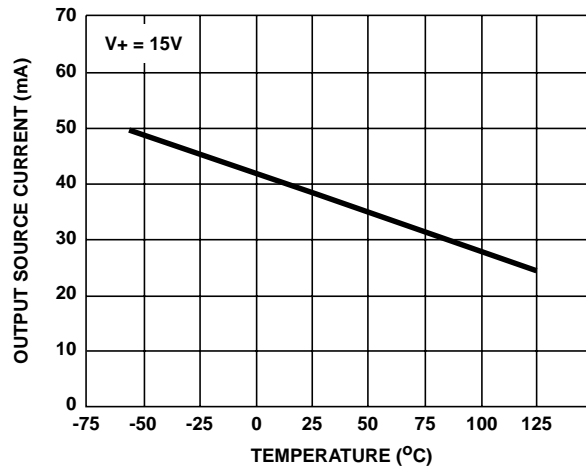
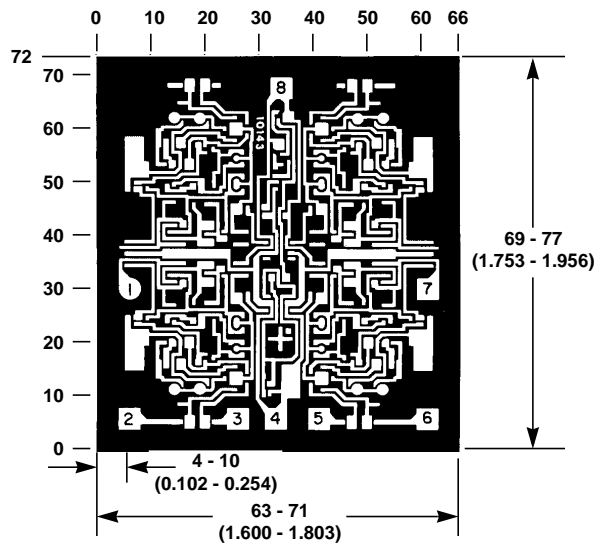

FIGURE 13. OUTPUT CURRENT vs AMBIENT TEMPERATURE

Metallization Mask Layout



Dimensions in parentheses are in millimeters and derived from the basic inch dimensions as indicated. Grid graduations are in mils (10^{-3} inch).

The photographs and dimensions represent a chip when it is part of the wafer. When the wafer is cut into chips, the cleavage angles are 57° instead of 90° with respect to the face of the chip. Therefore, the isolated chip is actually 7 mils (0.17mm) larger in both dimensions.

All Intersil semiconductor products are manufactured, assembled and tested under **ISO9000** quality systems certification.

Intersil semiconductor products are sold by description only. Intersil Corporation reserves the right to make changes in circuit design and/or specifications at any time without notice. Accordingly, the reader is cautioned to verify that data sheets are current before placing orders. Information furnished by Intersil is believed to be accurate and reliable. However, no responsibility is assumed by Intersil or its subsidiaries for its use; nor for any infringements of patents or other rights of third parties which may result from its use. No license is granted by implication or otherwise under any patent or patent rights of Intersil or its subsidiaries.

For information regarding Intersil Corporation and its products, see web site <http://www.intersil.com>