

Product diagram

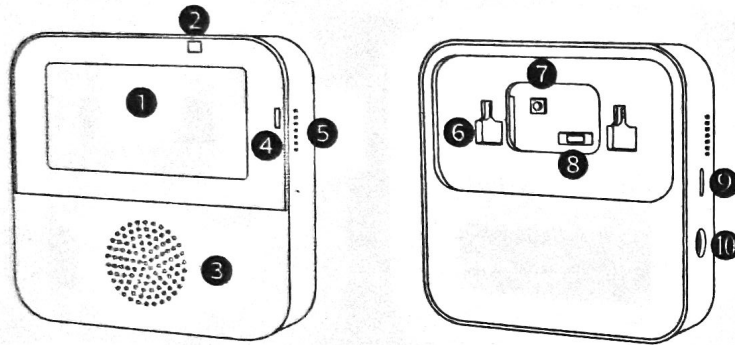

① Display screen	⑥ Install the hanging plate
② Brightness detector	⑦ Set key
③ Speaker	⑧ Battery powered switch
④ LED lights	⑨ USB Power supply interface
⑤ Temperature and humidity detector	⑩ External temperature sensor interface

Screen display introduction

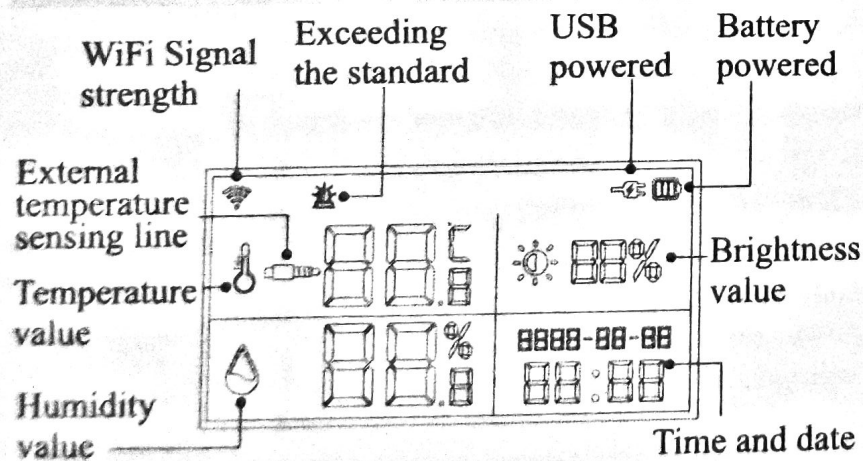

Connect with mobile APP

1. Download APP.



Tuya Smart



Smart Life

- Scan the QR code to download the APP.
- Please go to the application market to search for “Tuya Smart (Smart Life)”.

2. Login/Register APP.

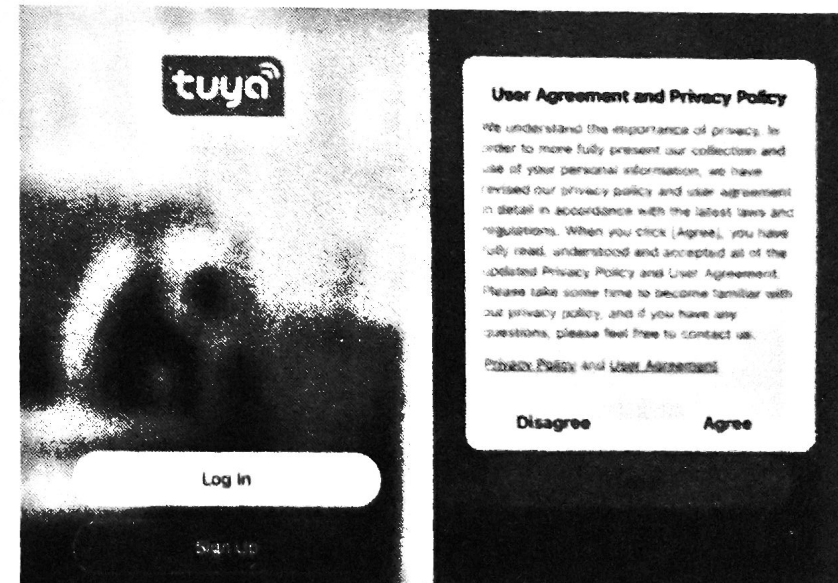

3. Network with mobile phone.

①

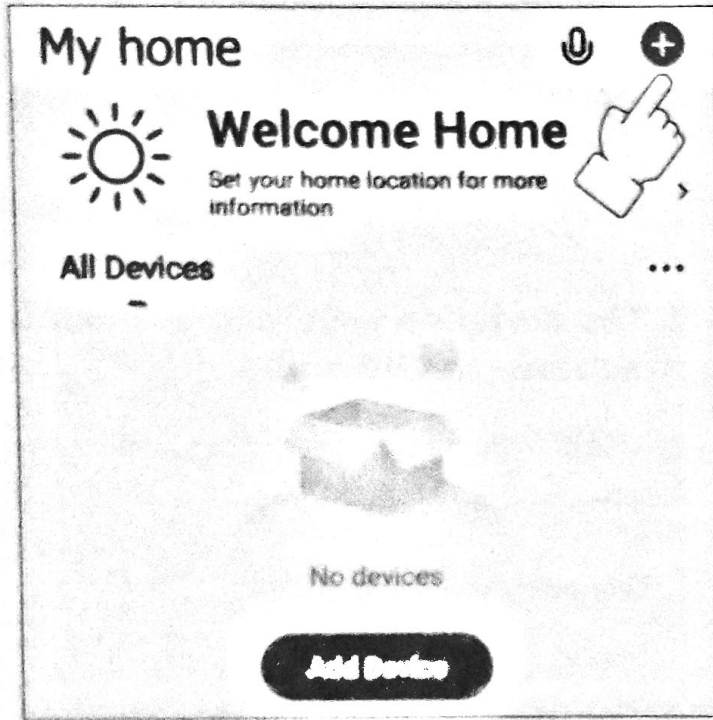

②

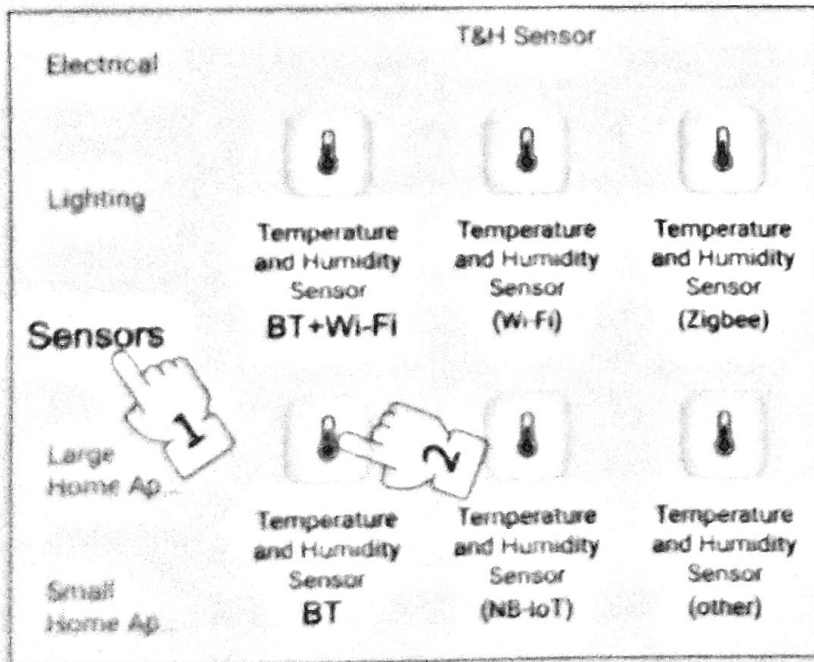

③

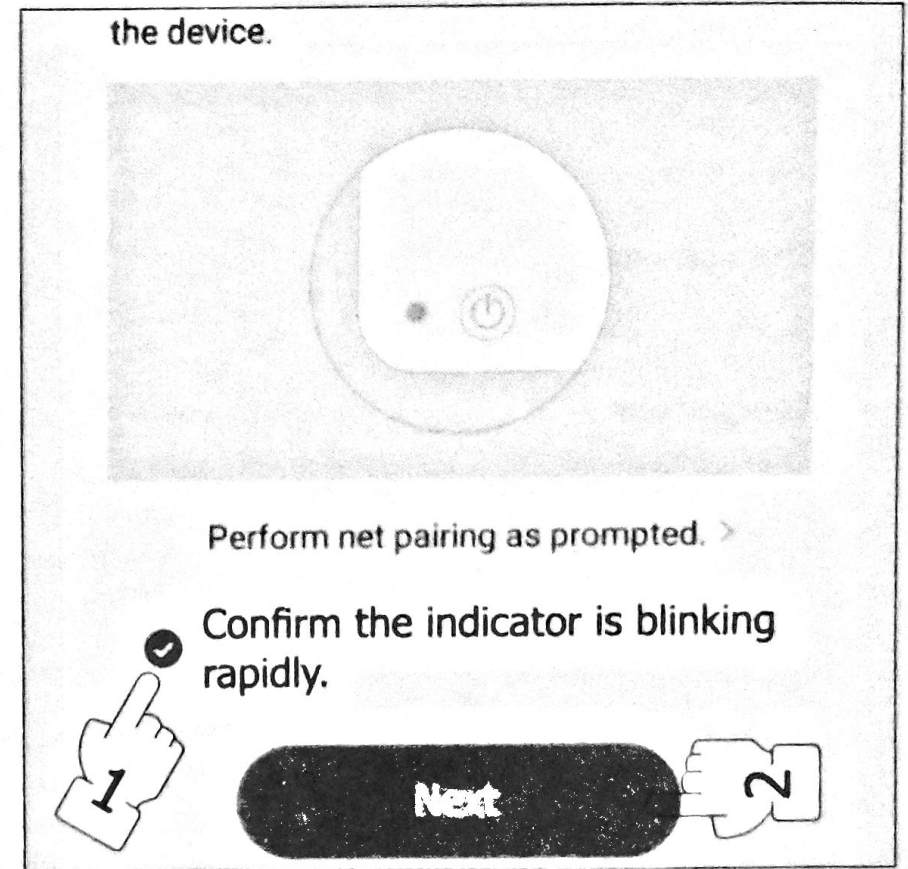

④ Allow BT to be turned on.

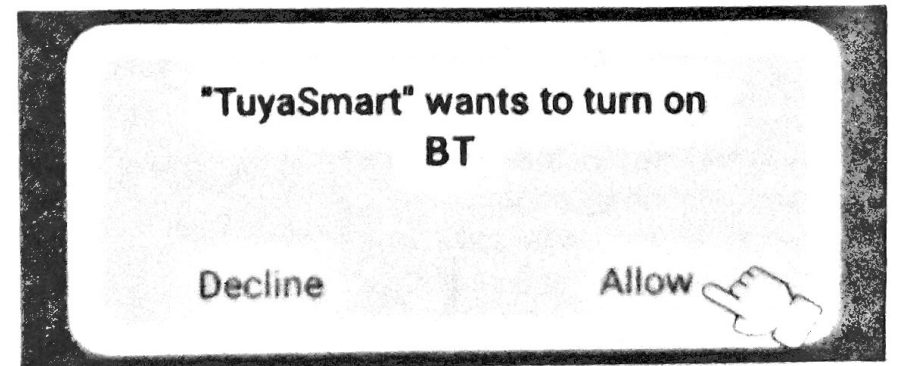

⑤ The device enters the state of network distribution.

- Press and hold the setting button for about 6 seconds.
- The monitor screen restarts.
- LED light flashes.

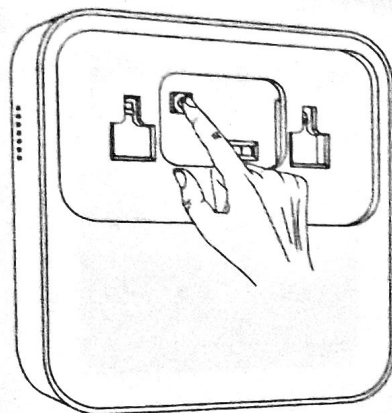

⑥ Scan for devices and add them.

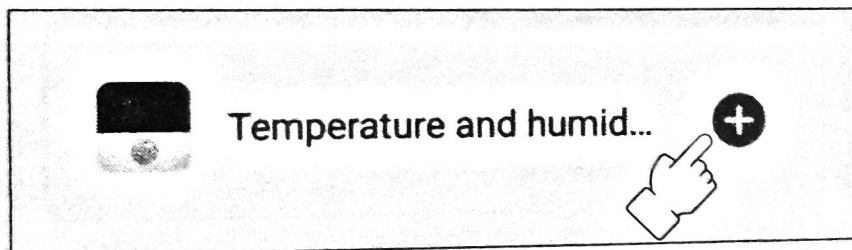

⑦ Connect to the current WiFi, and click Next.

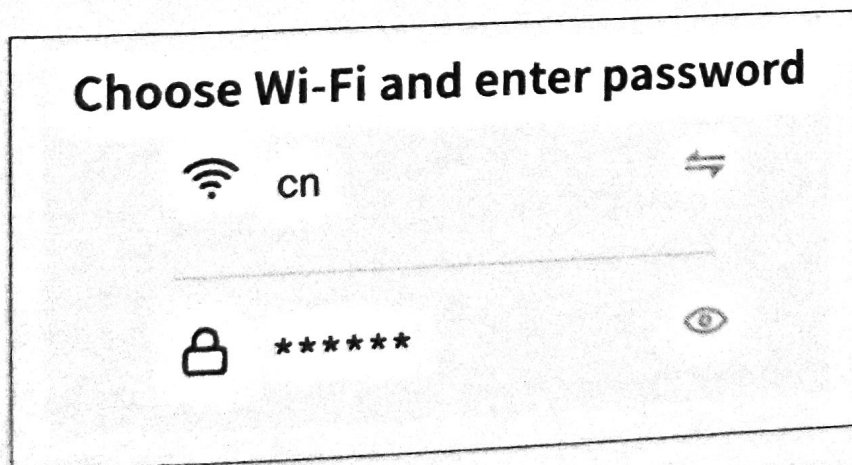

⑧ Being added.

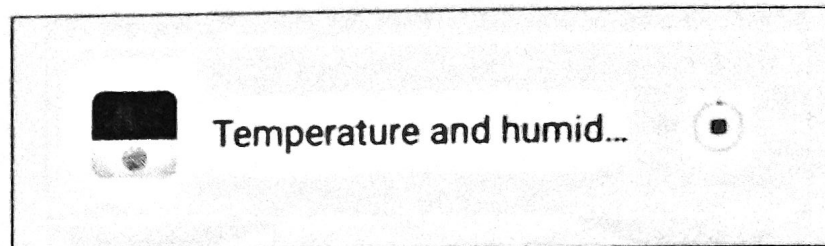

⑨ After adding, click Next.

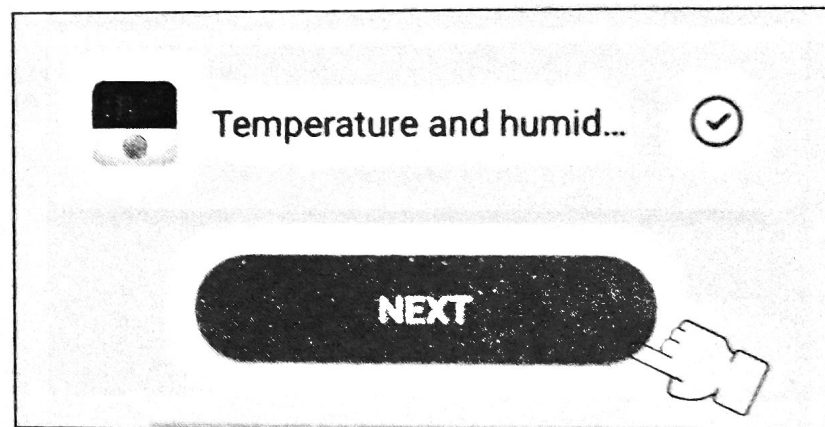

⑩ Click Done.

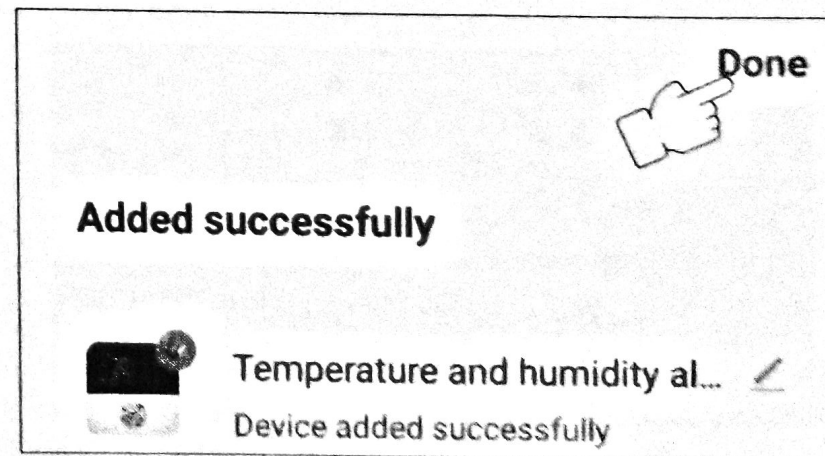

APP operation

1. APP introduction.

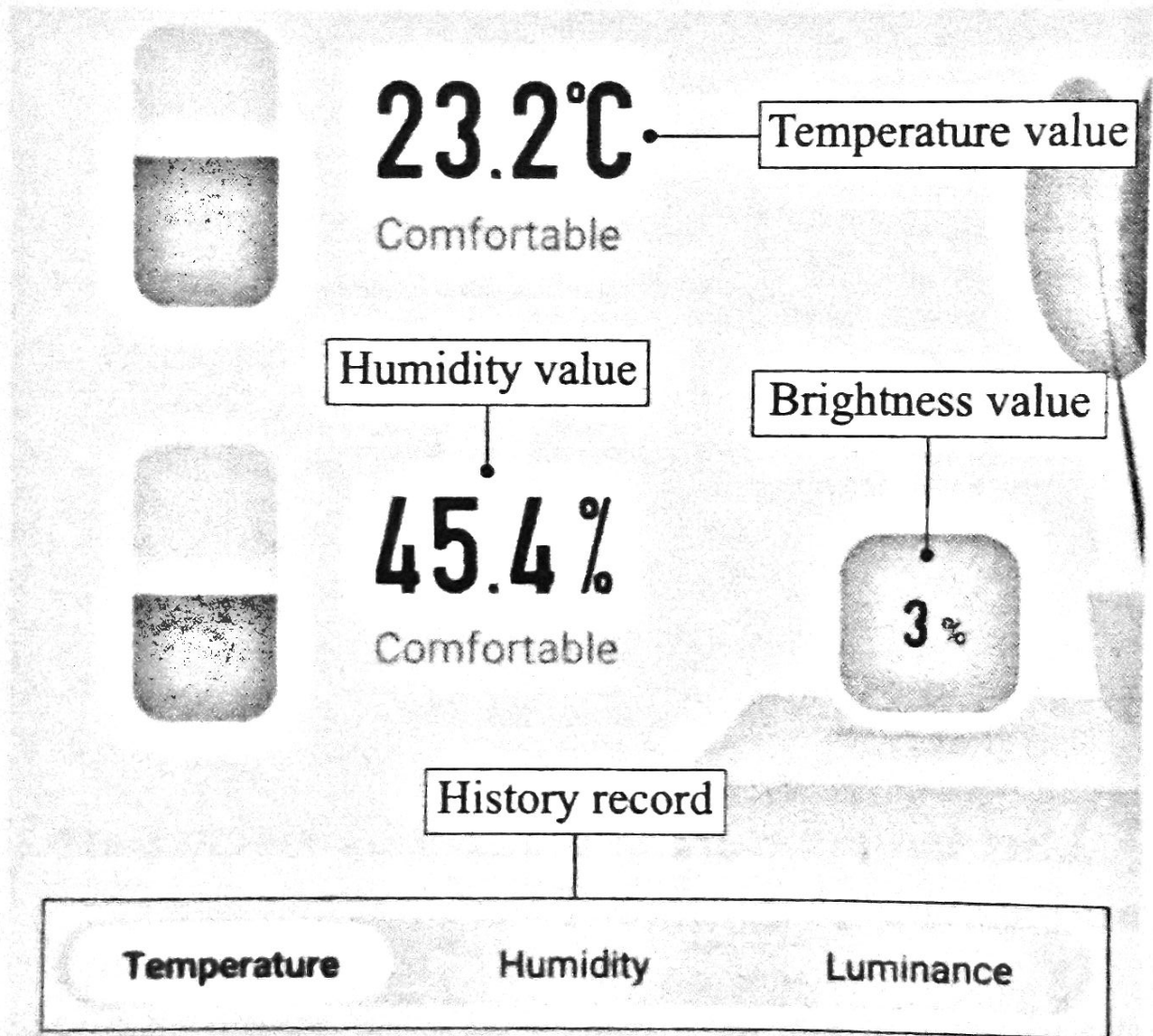

2. View temperature, humidity and brightness storage data.

① Click...

