

High Voltage IGBT

IXGH 16N170
IXGT 16N170

$V_{CES} = 1700 \text{ V}$
 $I_{C25} = 32 \text{ A}$
 $V_{CE(sat)} = 3.5 \text{ V}$

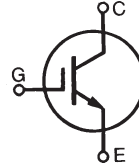

Symbol	Test Conditions	Maximum Ratings	
V_{CES}	$T_J = 25^\circ\text{C to } 150^\circ\text{C}$	1700	V
V_{CGR}	$T_J = 25^\circ\text{C to } 150^\circ\text{C}; R_{GE} = 1 \text{ M}\Omega$	1700	V
V_{GES}	Continuous	± 20	V
V_{GEM}	Transient	± 30	V
I_{C25}	$T_C = 25^\circ\text{C}$	32	A
I_{C90}	$T_C = 90^\circ\text{C}$	16	A
I_{CM}	$T_C = 25^\circ\text{C}, 1 \text{ ms}$	80	A
SSOA (RBSOA)	$V_{GE} = 15 \text{ V}, T_{VJ} = 125^\circ\text{C}, R_G = 10 \Omega$ Clamped inductive load	$I_{CM} = 40$ @ $0.8 V_{CES}$	A
P_C	$T_C = 25^\circ\text{C}$	190	W
T_J		-55 ... +150	$^\circ\text{C}$
T_{JM}		150	$^\circ\text{C}$
T_{stg}		-55 ... +150	$^\circ\text{C}$
T_L	1.6 mm (0.062 in.) from case for 10 s	300	$^\circ\text{C}$
T_{SOLD}	Plastic body for 10 s	260	$^\circ\text{C}$
M_d	Mounting torque (M3)	1.13/10Nm/lb.in.	
Weight	TO-247 AD	6	g
	TO-268	4	g

TO-268 (D3-Pak) (IXGT)

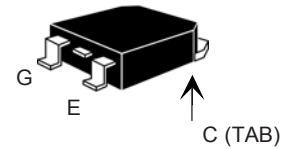

TO-247 (IXGH)

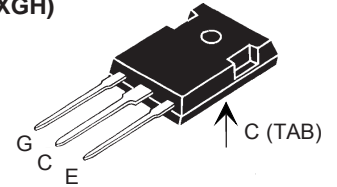

G = Gate, C = Collector,
E = Emitter, TAB = Collector

Features

- International standard packages JEDEC TO-268 and JEDEC TO-247 AD
- High current handling capability
- MOS Gate turn-on - drive simplicity
- Rugged NPT structure
- Molding epoxies meet UL 94 V-0 flammability classification

Applications

- Capacitor discharge & pulser circuits
- AC motor speed control
- DC servo and robot drives
- DC choppers
- Uninterruptible power supplies (UPS)
- Switched-mode and resonant-mode power supplies

Advantages

- High power density
- Suitable for surface mounting
- Easy to mount with 1 screw, (isolated mounting screw hole)

Symbol	Test Conditions	Characteristic Values ($T_J = 25^\circ\text{C}$, unless otherwise specified)		
		Min.	Typ.	Max.
BV_{CES}	$I_C = 250 \mu\text{A}, V_{GE} = 0 \text{ V}$	1700		V
$V_{GE(th)}$	$I_C = 250 \mu\text{A}, V_{CE} = V_{GE}$	3.0		V
I_{CES}	$V_{CE} = 0.8 \cdot V_{CES}$ $V_{GE} = 0 \text{ V}$	$T_J = 25^\circ\text{C}$		50 μA
		$T_J = 125^\circ\text{C}$		500 μA
I_{GES}	$V_{CE} = 0 \text{ V}, V_{GE} = \pm 20 \text{ V}$			$\pm 100 \text{ nA}$
$V_{CE(sat)}$	$I_C = I_{C90}, V_{GE} = 15 \text{ V}$	$T_J = 25^\circ\text{C}$	2.7	3.5 V
		$T_J = 125^\circ\text{C}$	3.3	V

Symbol	Test Conditions	Characteristic Values ($T_J = 25^\circ\text{C}$, unless otherwise specified)			
		Min.	Typ.	Max.	
g_{fs}	$I_C = I_{C90}$; $V_{CE} = 10\text{ V}$, Pulse test, $t \leq 300\ \mu\text{s}$, duty cycle $\leq 2\%$	10	14	S	
$I_{C(ON)}$	$V_{GE} = 10\text{ V}$, $V_{CE} = 10\text{ V}$		65	A	
C_{ies}	$V_{CE} = 25\text{ V}$, $V_{GE} = 0\text{ V}$, $f = 1\text{ MHz}$		1650	pF	
C_{oes}			75	pF	
C_{res}			26	pF	
Q_g	$I_C = I_{C90}$, $V_{GE} = 15\text{ V}$, $V_{CE} = 0.5 V_{CES}$		78	nC	
Q_{ge}			13	nC	
Q_{gc}			24	nC	
$t_{d(on)}$	Inductive load, $T_J = 25^\circ\text{C}$ $I_C = I_{C90}$, $V_{GE} = 15\text{ V}$ $V_{CE} = 0.8 V_{CES}$, $R_G = R_{off} = 10\ \Omega$		45	ns	
t_{ri}			48	ns	
$t_{d(off)}$			400	600	ns
t_{fi}			770	1100	ns
E_{off}			9.3	14	mJ
$t_{d(on)}$	Inductive load, $T_J = 125^\circ\text{C}$ $I_C = I_{C90}$, $V_{GE} = 15\text{ V}$ $V_{CE} = 0.8 V_{CES}$, $R_G = R_{off} = 10\ \Omega$		48	ns	
t_{ri}			42	ns	
E_{on}			1.5	mJ	
$t_{d(off)}$			430	ns	
t_{fi}			1170	ns	
E_{off}		11.2	mJ		
R_{thJC}			0.65	$^\circ\text{C/W}$	
R_{thCS}	(TO-247)	0.25		$^\circ\text{C/W}$	

TO-247 (IXGH) Outline

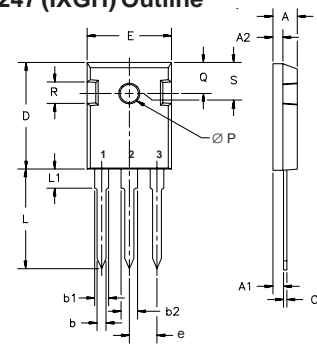

Terminals: 1 - Gate 2 - Drain
3 - Source Tab - Drain

Dim.	Millimeter		Inches	
	Min.	Max.	Min.	Max.
A	4.7	5.3	.185	.209
A ₁	2.2	2.54	.087	.102
A ₂	2.2	2.6	.059	.098
b	1.0	1.4	.040	.055
b ₁	1.65	2.13	.065	.084
b ₂	2.87	3.12	.113	.123
C	.4	.8	.016	.031
D	20.80	21.46	.819	.845
E	15.75	16.26	.610	.640
e	5.20	5.72	0.205	0.225
L	19.81	20.32	.780	.800
L ₁		4.50		.177
∅P	3.55	3.65	.140	.144
Q	5.89	6.40	0.232	0.252
R	4.32	5.49	.170	.216
S	6.15	BSC	242	BSC

TO-268 (IXGT) Outline (D3-Pak)

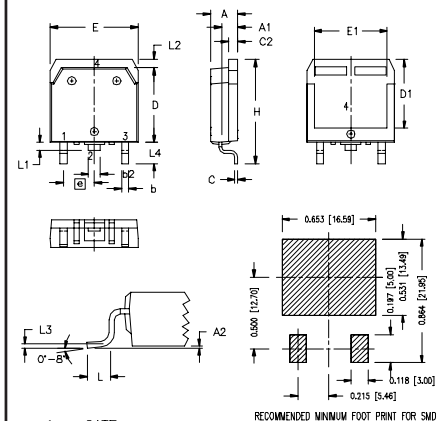

1 - GATE
2 - DRAIN (COLLECTOR)
3 - SOURCE (EMITTER)
4 - DRAIN (COLLECTOR)

SYM	INCHES		MILLIMETERS	
	MIN	MAX	MIN	MAX
A	.193	.201	4.90	5.10
A ₁	.106	.114	2.70	2.90
A ₂	.091	.090	0.92	0.25
b	.045	.057	1.15	1.45
b ₂	.075	.083	1.90	2.10
C	.016	.026	0.40	0.65
C ₂	.057	.063	1.45	1.60
D	.543	.551	13.80	14.00
D ₁	.488	.500	12.40	12.70
E	.624	.632	15.85	16.05
E ₁	.524	.535	13.30	13.60
e	.215 BSC		5.45 BSC	
H	.736	.752	18.70	19.10
L	.094	.106	2.40	2.70
L ₁	.047	.055	1.20	1.40
L ₂	.039	.045	1.00	1.15
L ₃	.010 BSC		0.25 BSC	
L ₄	.150	.161	3.80	4.10

Ref: IXYS CO 0052 RA

IXYS reserves the right to change limits, test conditions, and dimensions.

IXYS MOSFETs and IGBTs are covered by one or more of the following U.S. patents:	4,835,592	4,931,844	5,049,961	5,237,481	6,162,665	6,404,065 B1	6,683,344	6,727,585	7,005,734 B2
	4,850,072	5,017,508	5,063,307	5,381,025	6,259,123 B1	6,534,343	6,710,405 B2	6,759,692	
	4,881,106	5,034,796	5,187,117	5,486,715	6,306,728 B1	6,583,505	6,710,463	6,771,478 B2	

Fig. 1. Output Characteristics
 @ 25 Deg. C

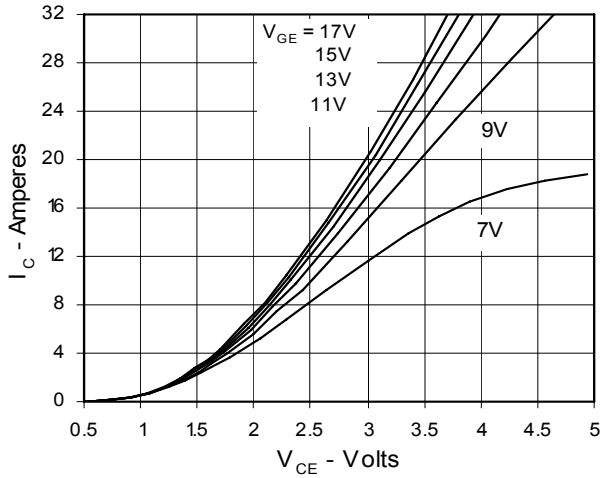

Fig. 2. Extended Output Characteristics
 @ 25 Deg. C

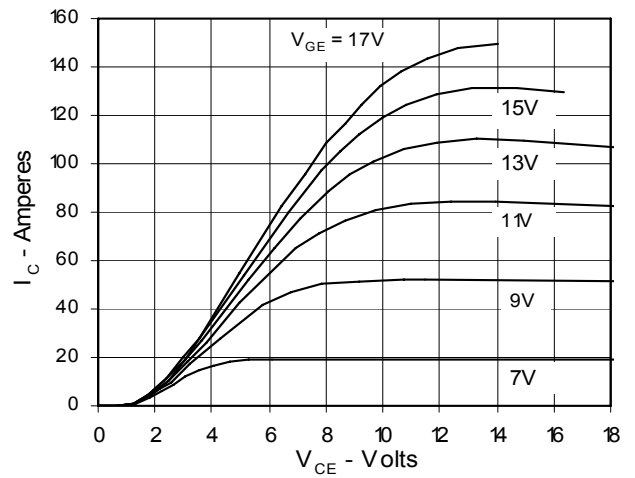

Fig. 3. Output Characteristics
 @ 125 Deg. C

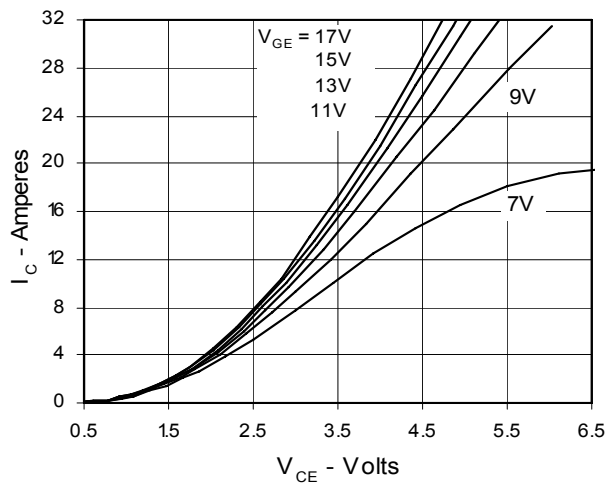

Fig. 4. Temperature Dependence of $V_{CE(sat)}$

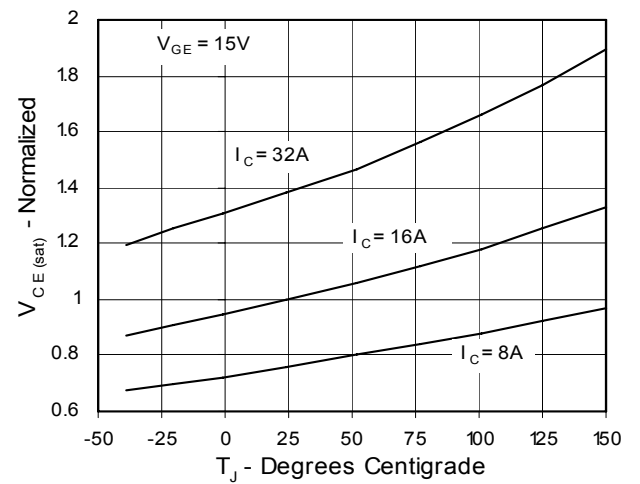

Fig. 5. Collector-to-Emitter Voltage vs. Gate-to-Emitter voltage

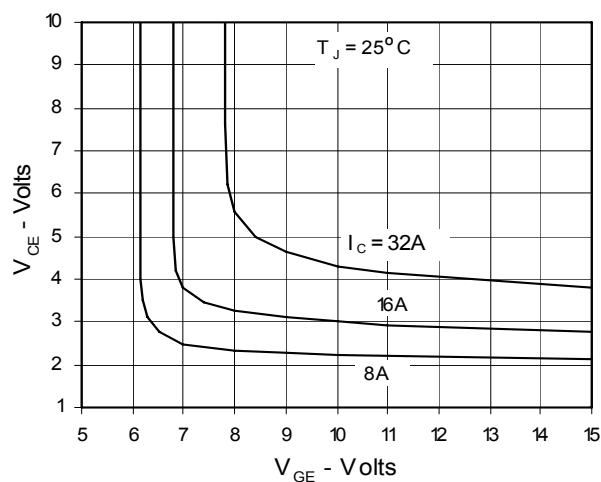

Fig. 6. Input Admittance

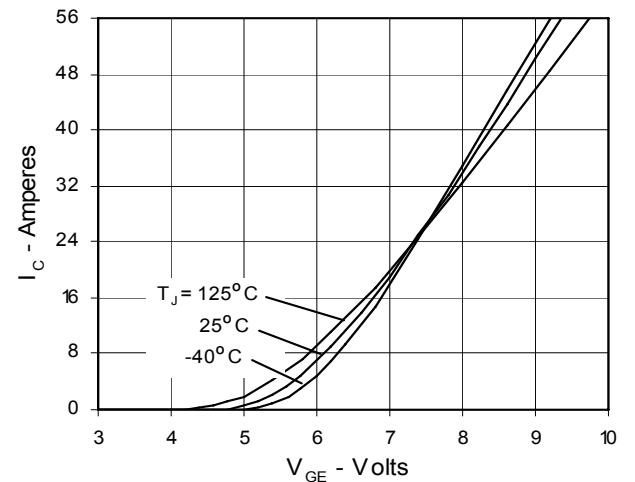

Fig. 7. Transconductance

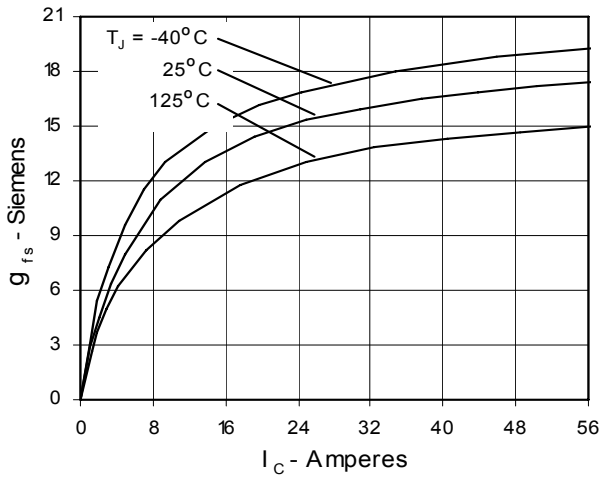

Fig. 8. Dependence of E_{off} on R_G

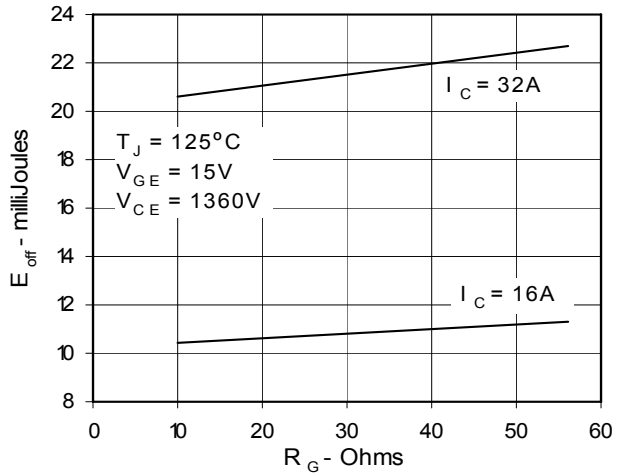

Fig. 9. Dependence of E_{off} on I_C

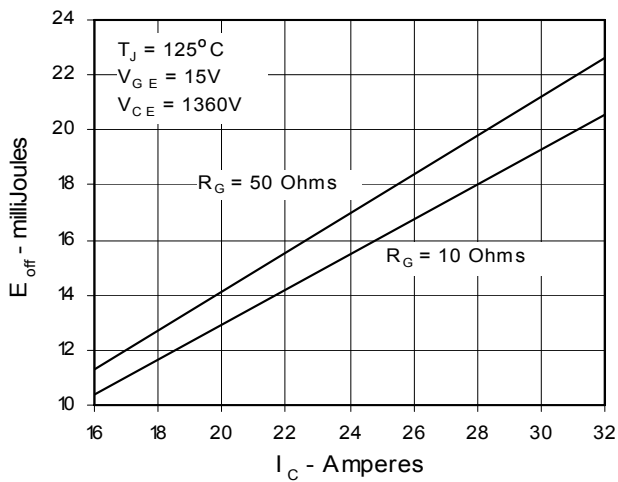

Fig. 10. Dependence of E_{off} on Temperature

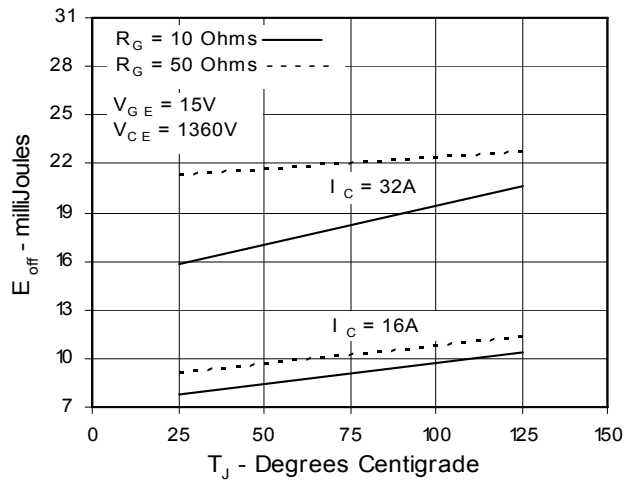

Fig. 11. Gate Charge

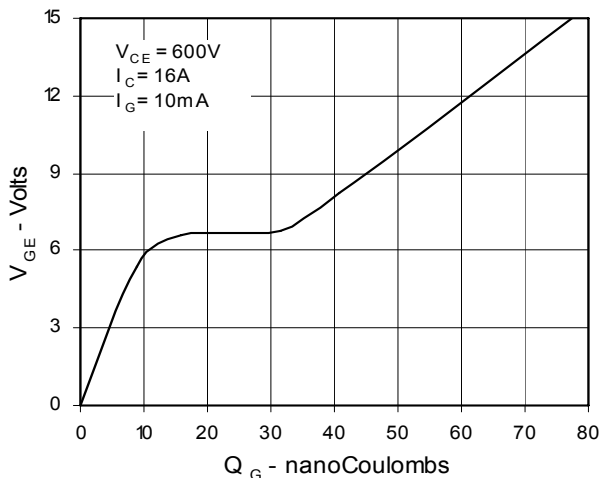

Fig. 12. Capacitance

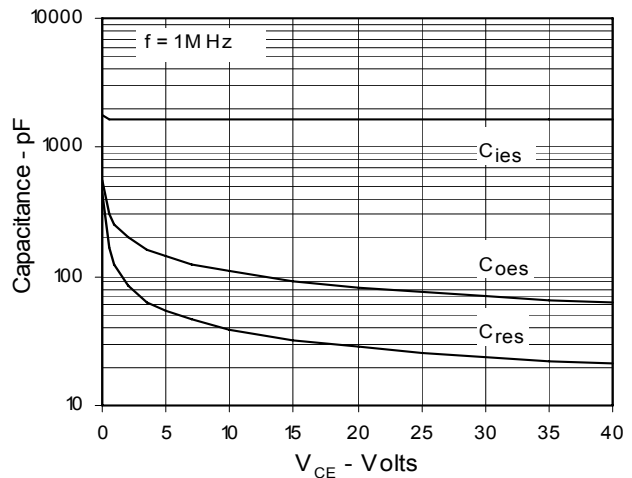

Fig. 13. Reverse-Bias Safe Operating Area

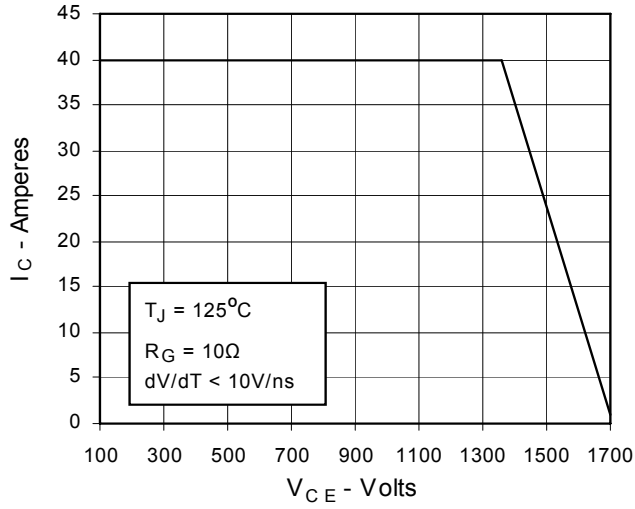
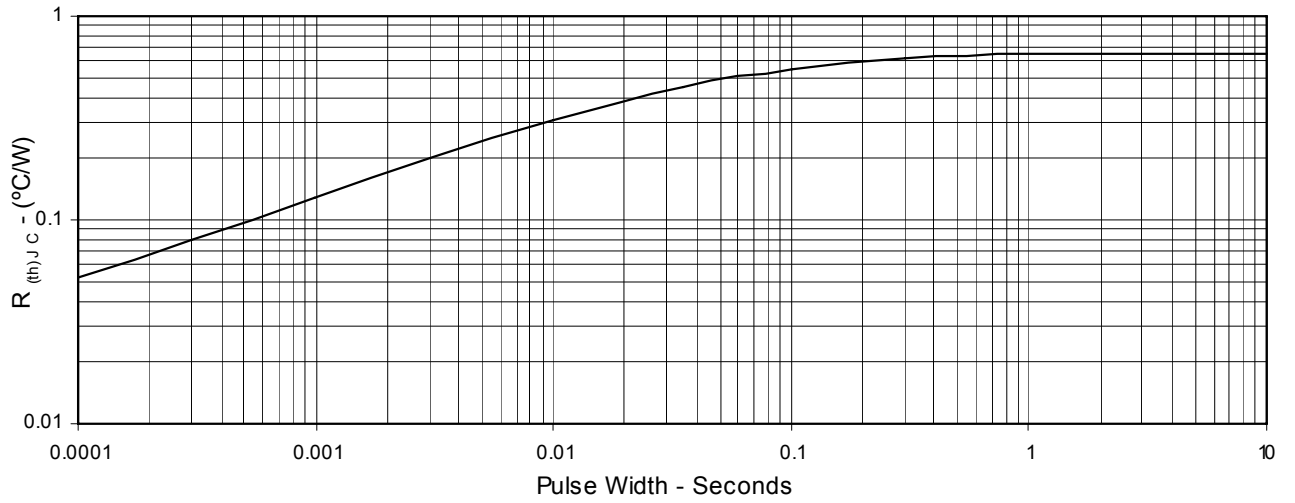

Fig. 14. Maximum Transient Thermal Resistance





Disclaimer Notice - Information furnished is believed to be accurate and reliable. However, users should independently evaluate the suitability of and test each product selected for their own applications. Littelfuse products are not designed for, and may not be used in, all applications. Read complete Disclaimer Notice at www.littelfuse.com/disclaimer-electronics.

Mouser Electronics

Authorized Distributor

Click to View Pricing, Inventory, Delivery & Lifecycle Information:

[IXYS:](#)

[IXGH16N170](#) [IXGT16N170](#)