



### ■ Features :

- Universal AC input / Full range (up to 295VAC)
- Fully isolated plastic case with IP64 level
- Built-in constant current limiting circuit with adjustable OCP level
- Protections: Short circuit/Over load/Over voltage/Over temperature
- Built-in active PFC function
- Pass LPS
- IP64 design for indoor or outdoor installations
- Cooling by free air convection
- 100% full load burn-in test
- High reliability
- Suitable for LED lighting and moving sign applications (Note.2)
- Compliance to worldwide safety regulations for lighting
- 2 years warranty

### SPECIFICATION



MODEL	PLN-30-9	PLN-30-12	PLN-30-15	PLN-30-20	PLN-30-24	PLN-30-27	PLN-30-36	PLN-30-48	
OUTPUT	DC VOLTAGE	9V	12V	15V	20V	24V	27V	36V	48V
	CONSTANT CURRENT REGION Note.6	6.3 ~ 9V	8.4 ~ 12V	10.5 ~ 15V	14 ~ 20V	16.8 ~ 24V	18.9 ~ 27V	25.2 ~ 36V	33.6 ~ 48V
	RATED CURRENT	3.3A	2.5A	2A	1.5A	1.25A	1.12A	0.84A	0.63A
	CURRENT RANGE	0 ~ 3.3A	0 ~ 2.5A	0 ~ 2A	0 ~ 1.5A	0 ~ 1.25A	0 ~ 1.12A	0 ~ 0.84A	0 ~ 0.63A
	RATED POWER	29.7W	30W	30W	30W	30W	30.24W	30.24W	30.24W
	RIPPLE & NOISE (max.) Note.2	2.6Vp-p	2Vp-p	2.6Vp-p	2.6Vp-p	2.6Vp-p	2.3Vp-p	4.5Vp-p	3.7Vp-p
	VOLTAGE ADJ. RANGE Note.5	-5% ~ 10%. Can be adjusted by internal potential meter SVR1							
	CURRENT ADJ. RANGE Note.5	3% ~ -25%. Can be adjusted by internal potential meter SVR2							
	VOLTAGE TOLERANCE Note.3	±10%							
	LINE REGULATION	±3.0%							
LOAD REGULATION	±5.0%								
SETUP TIME	1500ms / 230VAC 3000ms / 115VAC at full load								
INPUT	VOLTAGE RANGE Note.4	90 ~ 295VAC 127 ~ 417VDC							
	FREQUENCY RANGE	47 ~ 63Hz							
	POWER FACTOR	PF ≥ 0.9 at 75 ~ 100% load, 115VAC / 230VAC							
	EFFICIENCY(Typ.)	80%	82.5%	83.5%	84%	84%	84.5%	85%	85.5%
	AC CURRENT	0.4A/115VAC 0.2A/230VAC							
	INRUSH CURRENT(max.)	40A/230VAC							
LEAKAGE CURRENT	<0.5mA / 240VAC								
PROTECTION	OVER CURRENT	100 ~ 110% Protection type : Constant current limiting, recovers automatically after fault condition is removed							
	SHORT CIRCUIT	Hiccup mode, recovers automatically after fault condition is removed.							
	OVER VOLTAGE	10 ~ 14V	14 ~ 16V	17 ~ 22V	23 ~ 26V	27 ~ 34V	31 ~ 35V	40 ~ 50V	53 ~ 63V
	OVER TEMPERATURE	95°C ±10°C (TSW1) Protection type : Shut down o/p voltage, re-power on to recover							
ENVIRONMENT	WORKING TEMP.	-30 ~ +50°C (Refer to output load derating curve)							
	WORKING HUMIDITY	20 ~ 95% RH non-condensing							
	STORAGE TEMP., HUMIDITY	-40 ~ +80°C, 10 ~ 95% RH							
	TEMP. COEFFICIENT	±0.06%/°C (0 ~ 50°C)							
	VIBRATION	10 ~ 500Hz, 2G 12min./1cycle, period for 72min. each along X, Y, Z axes							
SAFETY & EMC	SAFETY STANDARDS	UL879, TUV EN61347-1, EN61347-2-13, CAN/CSA C22.2 No. 223-M91(except for 48V), IP64 approved							
	WITHSTAND VOLTAGE	I/P-O/P: 3.75KVAC							
	ISOLATION RESISTANCE	I/P-O/P: 100M Ohms / 500VDC / 25°C / 70% RH							
	EMI CONDUCTION & RADIATION	Compliance to EN55015							
	HARMONIC CURRENT	Compliance to EN61000-3-2 Class C (pin ≥ 25W), Class D (>70% load) ; EN61000-3-3							
	EMS IMMUNITY	Compliance to EN61000-4-2,3,4,5,6,8,11; ENV50204, EN55024, EN61547, light industry level, criteria A							
OTHERS	MTBF	621.4Khrs min. MIL-HDBK-217F (25°C)							
	DIMENSION	145*47*30mm (L*W*H)							
	PACKING	0.22Kg; 60pcs/14.2Kg/1.25CUFT							

**NOTE**

1. All parameters NOT specially mentioned are measured at 230VAC input, rated load and 25°C of ambient temperature.
2. Ripple & noise are measured at 20MHz of bandwidth by using a 12" twisted pair-wire terminated with a 0.1uf & 47uf parallel capacitor. Direct connecting to LEDs is not suggested for models with "RIPPLE & NOISE" >±10% and using additional drivers is highly recommended.
3. Tolerance : includes set up tolerance, line regulation and load regulation.
4. Derating may be needed under low input voltage. Please check the static characteristics for more details.
5. Output voltage can be adjusted through the SVR1 on the PCB; limit of output constant current level can be adjusted through the SVR2 on the PCB.
6. Constant current operation region is within 70% ~ 100% rated output voltage. This is the suitable operation region for LED related applications, but please reconfirm special electrical requirements for some specific system design.
7. The power supply is considered as a component that will be operated in combination with final equipment. Since EMC performance will be affected by the complete installation, the final equipment manufacturers must re-qualify EMC Directive on the complete installation again.

## Mechanical Specification

Case No.964A Unit:mm

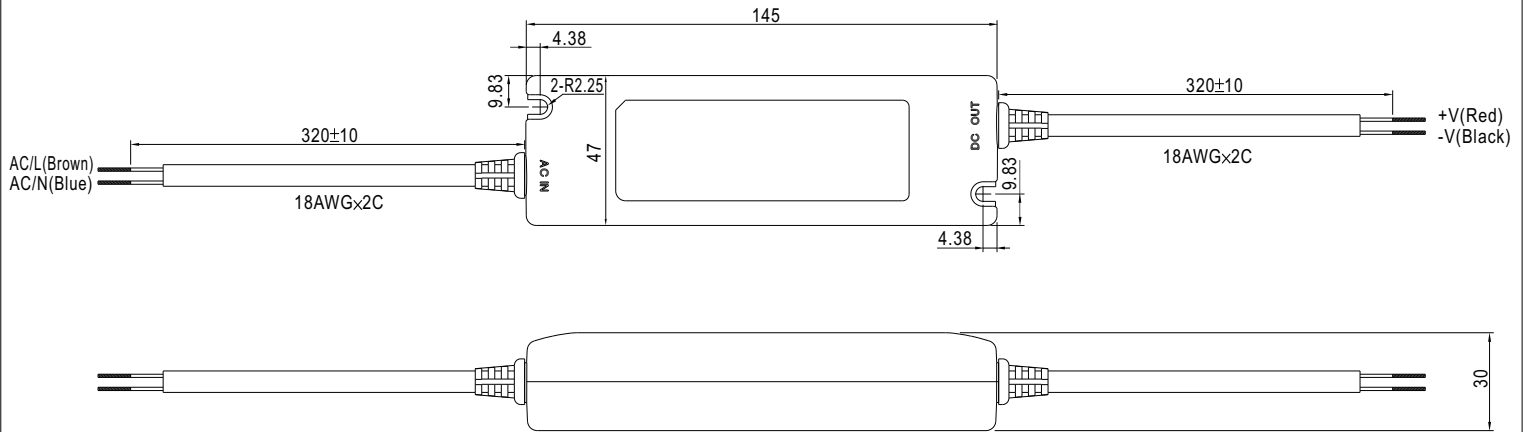

Output voltage and current adjustment : remove the upper case and adjust through SVR1 & SVR2 shown in the diagram.

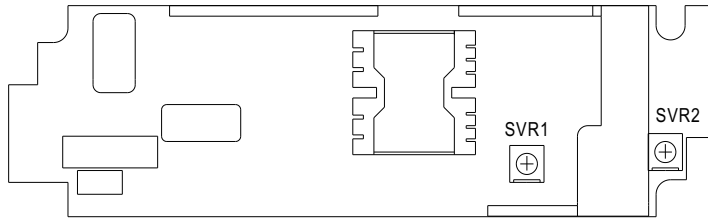

SVR1	Output voltage adjustment
SVR2	Output current adjustment

## Block Diagram

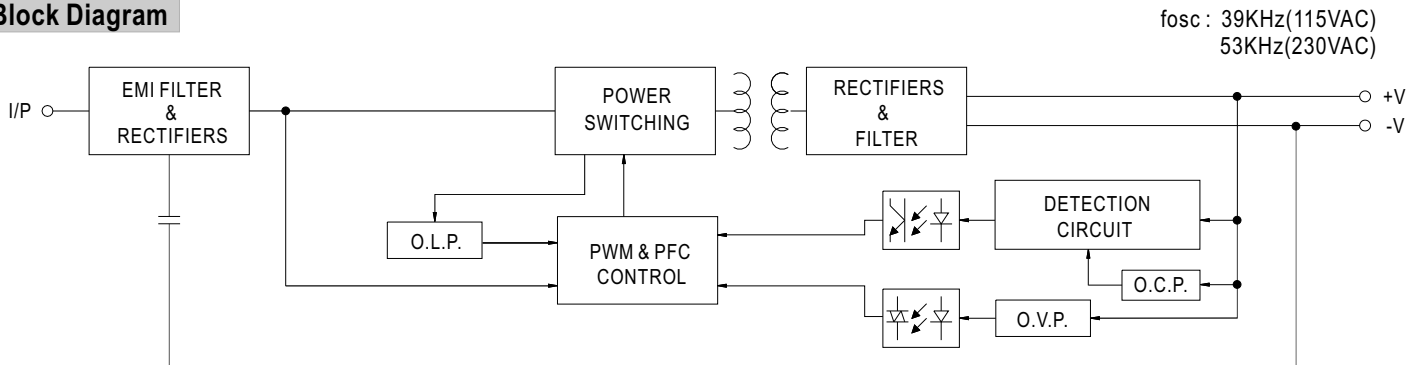

## Derating Curve

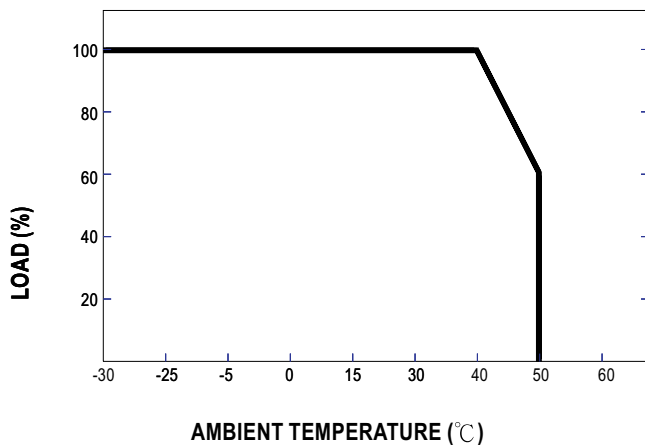

## Static Characteristics

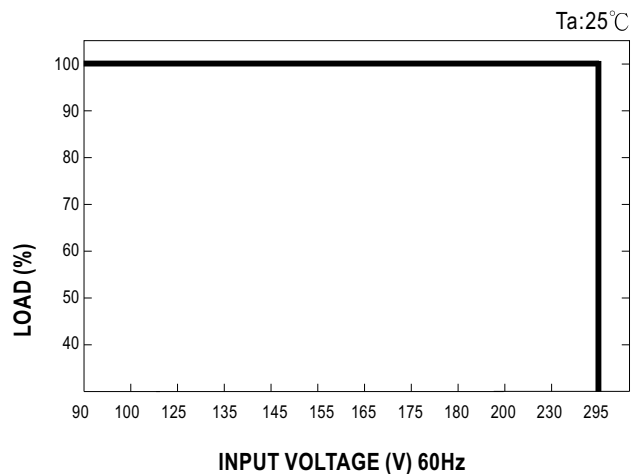

**Power Factor Characteristic**

Power factor will be higher than 0.9 when output loading is 75% or higher.

**Constant Current Mode**

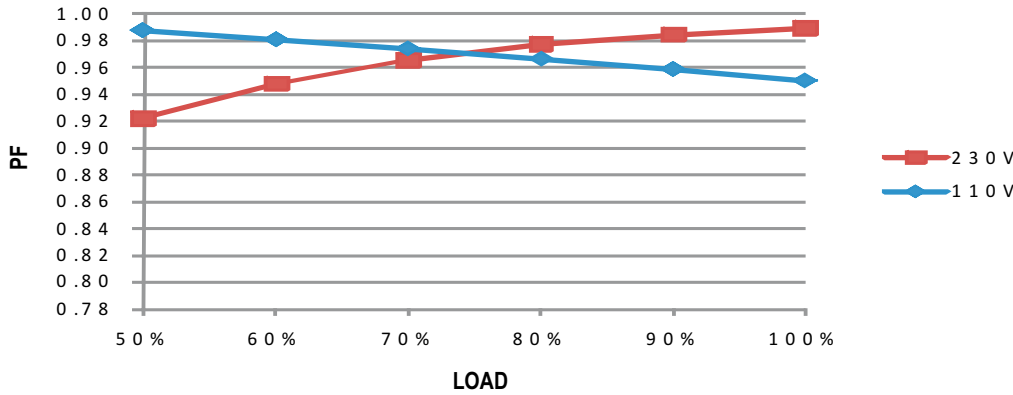

**EFFICIENCY vs LOAD (48V Model)**

PLN-30 series possess superior working efficiency that up to 85.5% can be reached in field applications.

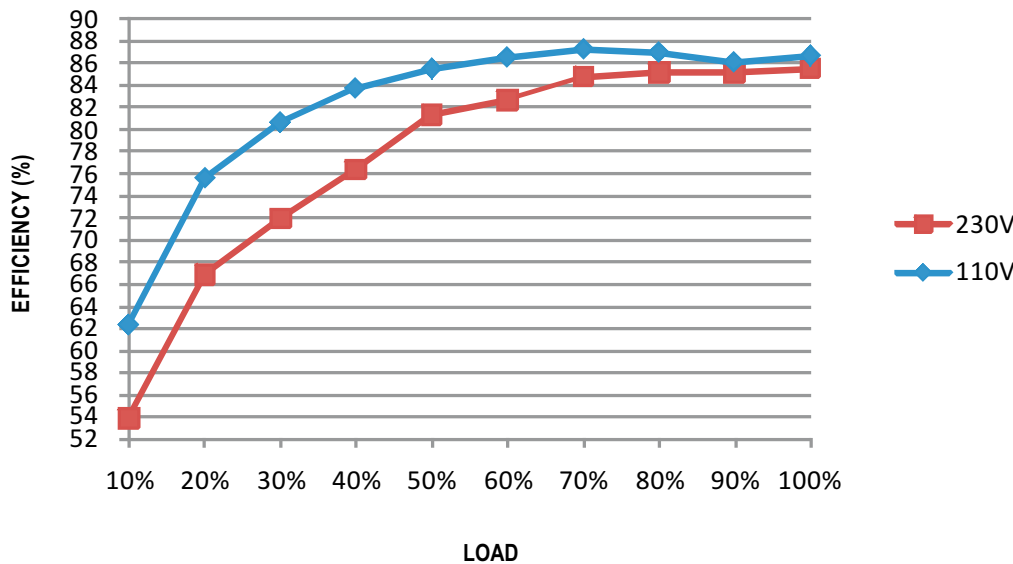

**DRIVING METHODS OF LED MODULE**

There are two major kinds of LED drive method "direct drive" and "with LED driver".

A typical LED power supply may either work in "constant voltage mode (CV) or constant current mode (CC)" to drive the LEDs.

Mean Well's LED power supply with CV+ CC characteristic can be operated at both CV mode [with LED driver, at area (A)] and CC mode [direct drive, at area (B)].

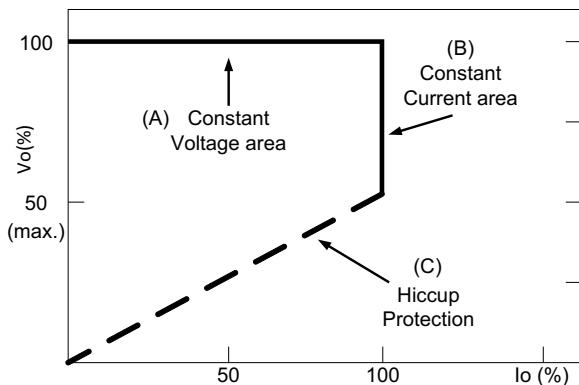

Typical LED power supply I-V curve