

ERD SERIES 10x10 SIZE SEALED CONSTRUCTION ROTARY TYPE

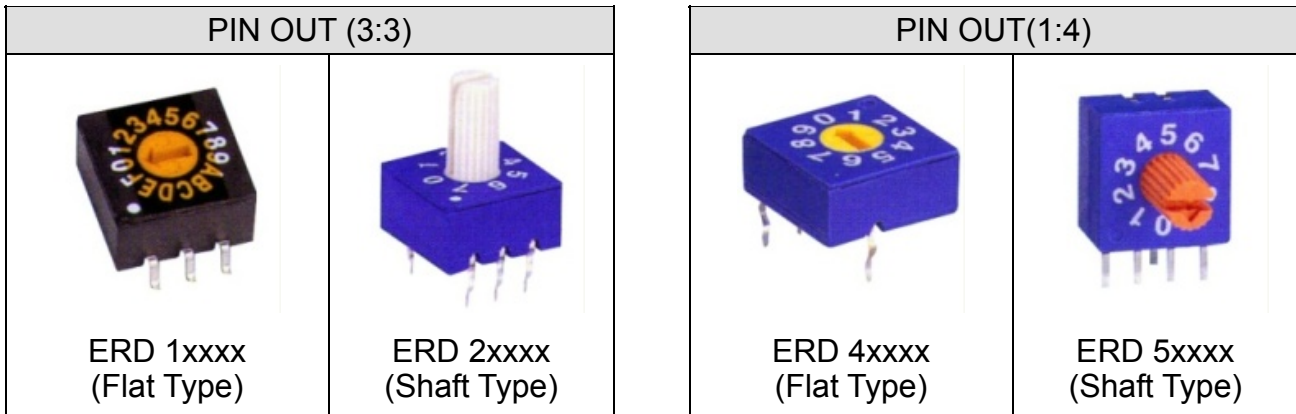

■ FEATURES

- Molded-in terminals and fully sealed construction.
- All plastics UL 94V-0 grade fire retardant.
- Reliable contact and long-term stability.
- Binary decimal (8 or 10 positions) and hexadecimal (16 positions), real and complementary codes available.
- Pin-out compatible with most of current equivalents.
- Gold plated contacts to ensure low contact resistance.

■ APPLICATIONS

- Address switching applications
- Data storage devices
- Computer and peripherals
- Instrumentation

■ SPECIFICATIONS

1.ELECTRICAL

● Contact rating	switching	25mA, 24VDC
	non-switching	100mA
● Contact resistance	100mΩ Max.	
● Insulation resistance	1000MΩ Min. at 100VDC	
● Dielectric strength	250VAC Min. for 60 seconds	

2.MECHANICAL AND ENVIRONMENTAL

● Temperature rating	operating	-25°C to +70°C
	Storage	-40°C to +85°C
● Operation force	500 gf-cm Max.	



Switch

● Mechanical life	2000 steps per position
● Vibration	10Hz-50Hz-10Hz for 6 Hrs.
● Solderability (for through hole type)	after flux 230±5°C for 5±0.5 seconds,95% coverage
● Resistance to soldering heat (for through hole type)	260±5°C for 5±1 seconds
● Reflow soldering heat for SMT type(reference only)	<p>The graph shows a reflow soldering temperature profile. The y-axis is Temperature (°C) with markers at 150, 180, 240, and 260. The x-axis is Time (sec) with markers for 120-150 sec and 20 sec Max. The curve starts at a low temperature, rises to 150°C, then to 180°C, and finally peaks at 260°C before cooling down. A horizontal dashed line at 240°C is also shown.</p>

■ PART NUMBERING SYSTEM

ERD 1 10 R S Z

Z: RoHS Compliant

Setting :

S: Standard Type (Top Adjust Type)

R: Right Angle Type with Row Spacing 2.54 mm (Side Adjust Type)

F: Right Angle Type with Row Spacing 5.08 mm (Side Adjust Type)

M: Surface Mounting Type with Top Tape Sealed

D: Surface Mounting Type with Top Tape Sealed in Tape & Reel Package

Code:

R: Real

C: Complement

A: Real / Cross Shaped Slot Type

B: Complement / Cross Shaped Solt Type

Number of positions:

08,10,16

Rotor:

1: Flat Type (pin out 3 :3)

2: Shaft Type (pin out 3:3)

4: Flat Type (pin out 1:4)

5: Shaft Type (pin out 1:4)

Series name:

ERD: Rotary Type Sealed Construction

CODE

PIN NO.	POSITIONS															
	0	1	2	3	4	5	6	7	8	9	A	B	C	D	E	F
1	○	●	○	●	○	●	○	●	○	●	○	●	○	●	○	●
2	○	○	●	●	○	○	●	●	○	○	●	●	○	○	●	●
4	○	○	○	○	●	●	●	●	○	○	○	○	●	●	●	●
8	○	○	○	○	○	○	○	○	○	●	●	●	●	●	●	●

- ... Real Code
Rotor color:
White (3:3), Yellow (1:4)
- ... Complement Code
Rotor color:
Red (3:3), Orange (1:4)

CONSTRUCTION

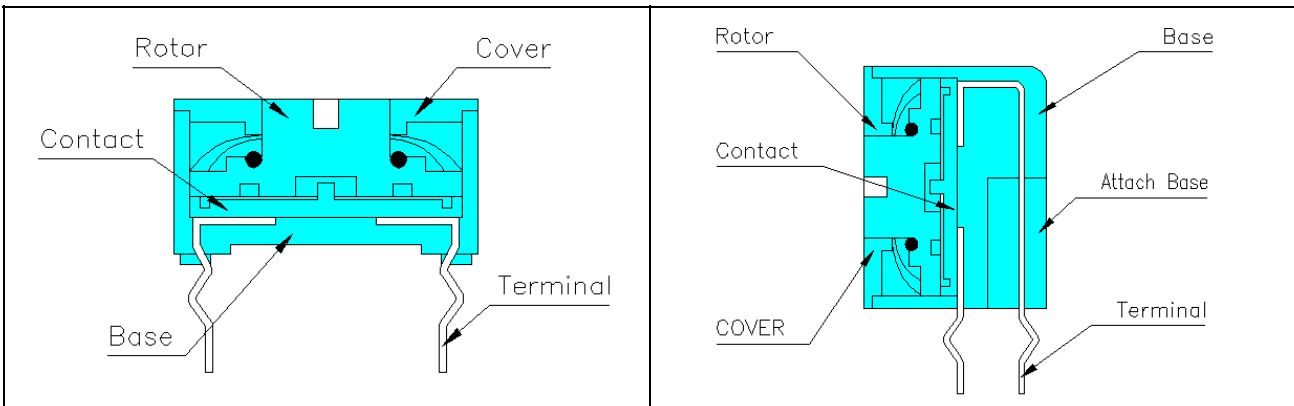

PACKING

1. Tape & Reel Packaging (Per EIA STANDARD)

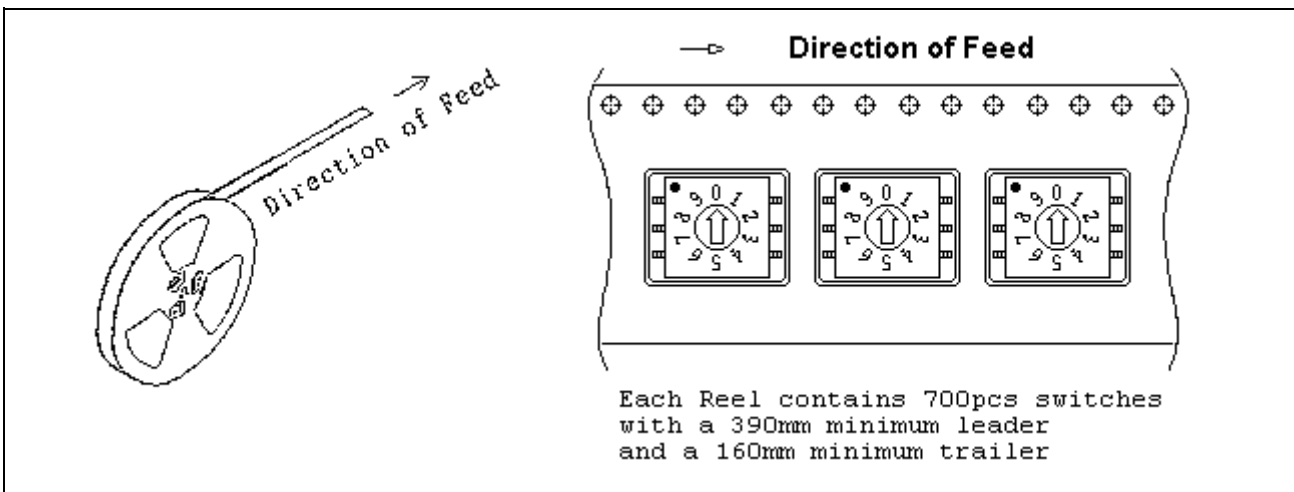

■ OPTIONS

1.Special marking available upon request

2.Shaft Cover

- 418-80100(White 3:3)
- 418-80200(Red 3:3)
- 418-80300(Yellow 1:4)
- 418-80400(Orange 1:4)

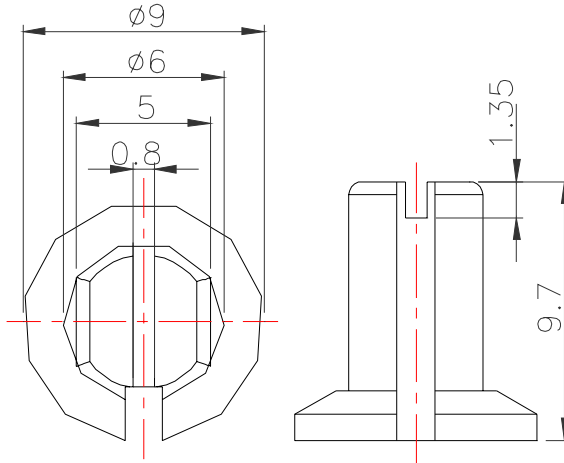
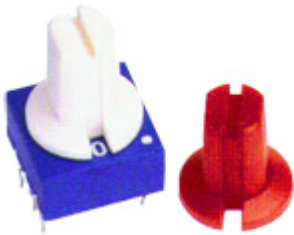

3.Shaft (For Cross Slot Type Only)

- 418-90010(White 3:3)
- 418-90020(Red 3:3)

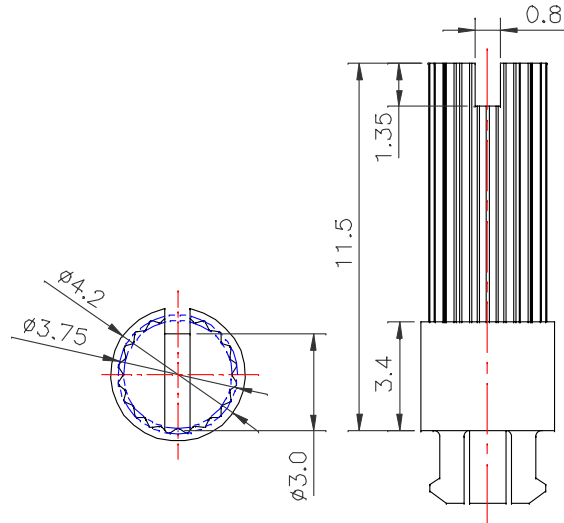

■ INTRODUCTION to ECE ROTARY DIP SWITCH

SIZE	POSITIONS	CODE	PIN OUT	ROTOR	TYPE	PART NUMBER
10x10	8,10,16	REAL, COMPLEMENT	3:3	FLAT, SHAFT	STANDARD	ERD1xxxS,ERD2xxxS
					RIGHT ANGLE	ERD1xxxR/F,ERD2xxR/F
				FLAT	SMT	ERD1xxxM
					SMT IN T&R	ERD1xxxD
			1:4	FLAT, SHAFT	STANDARD	ERD4xxxS,ERD5xxxS
					RIGHT ANGLE	ERD4xxxR/F,ERD5xxxR/F
				FLAT	SMT	ERD4xxxM
					SMT IN T&R	ERD4xxxD

■ DIMENSIONS AND CIRCUITRY UNIT:mm(inch) PIN OUT 3:3

ERD1xxxS Flat Type

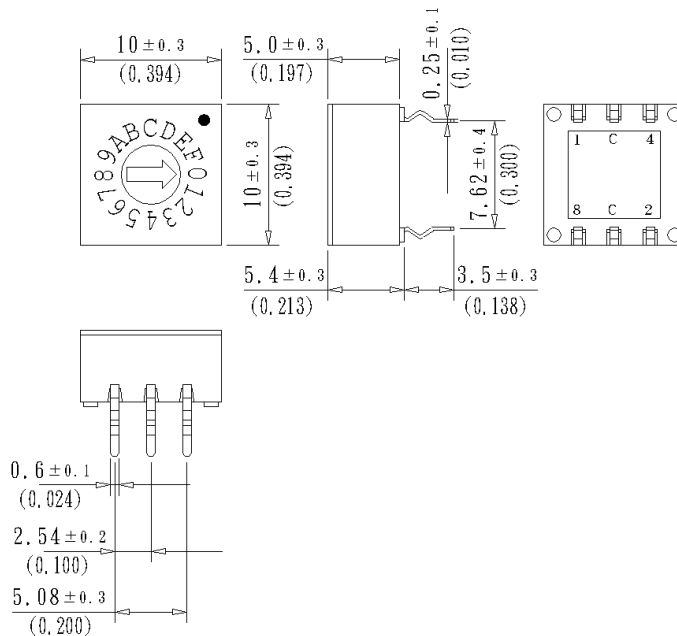

ERD2xxxS Shaft Type

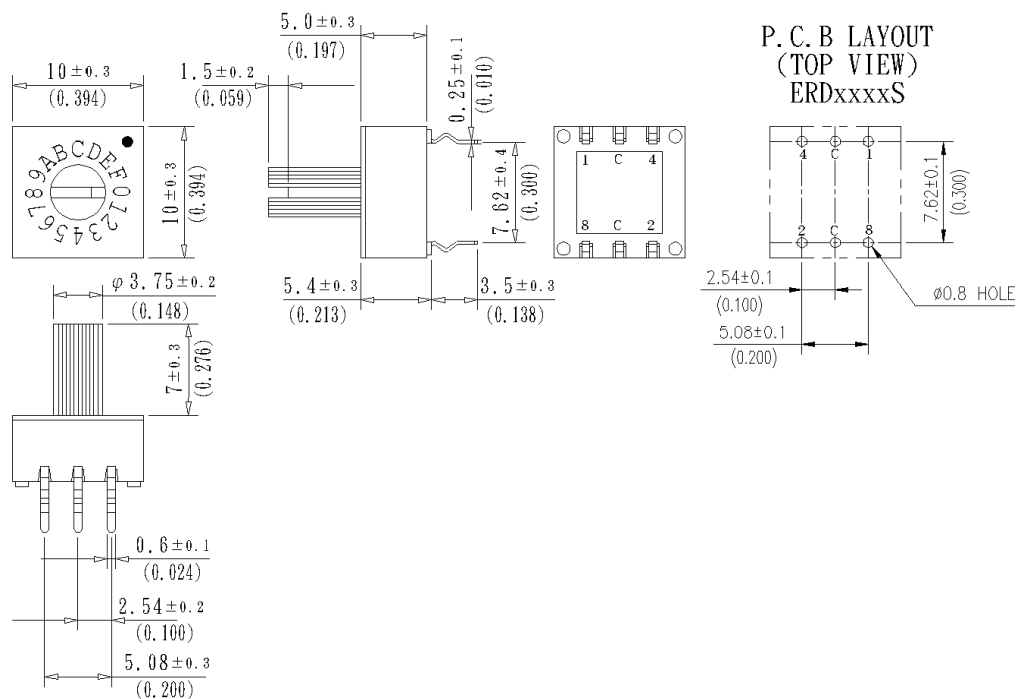

ERD1xxxR Flat Type

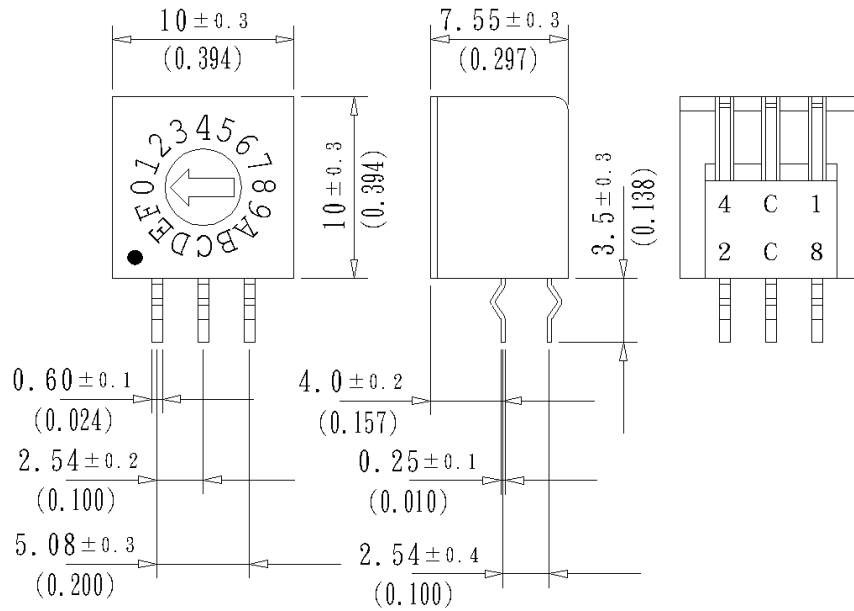

ERD2xxxR Shaft Type

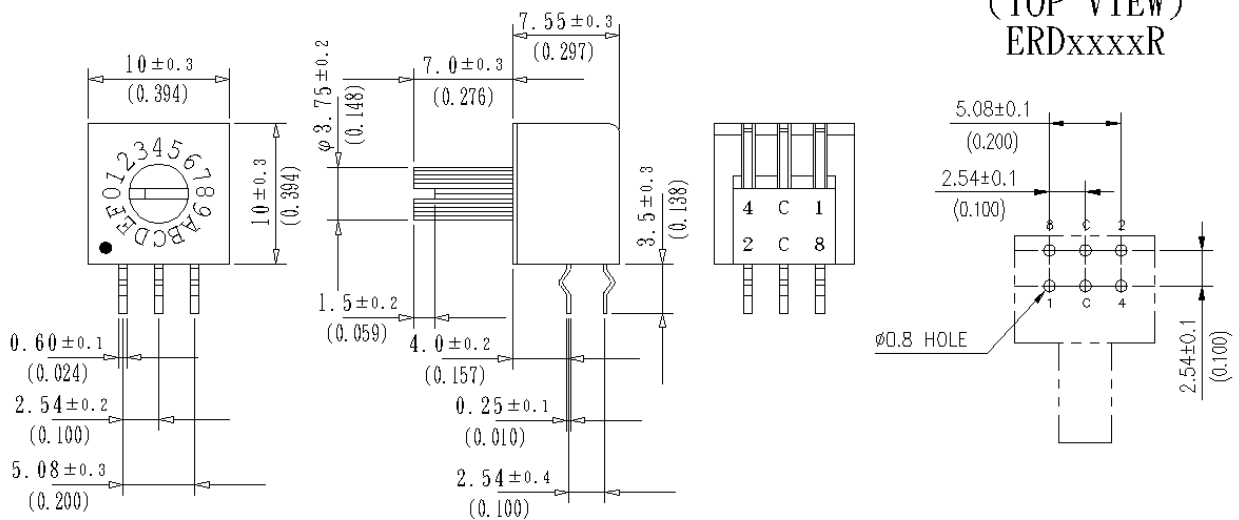

ERD1xxxF Flat Type

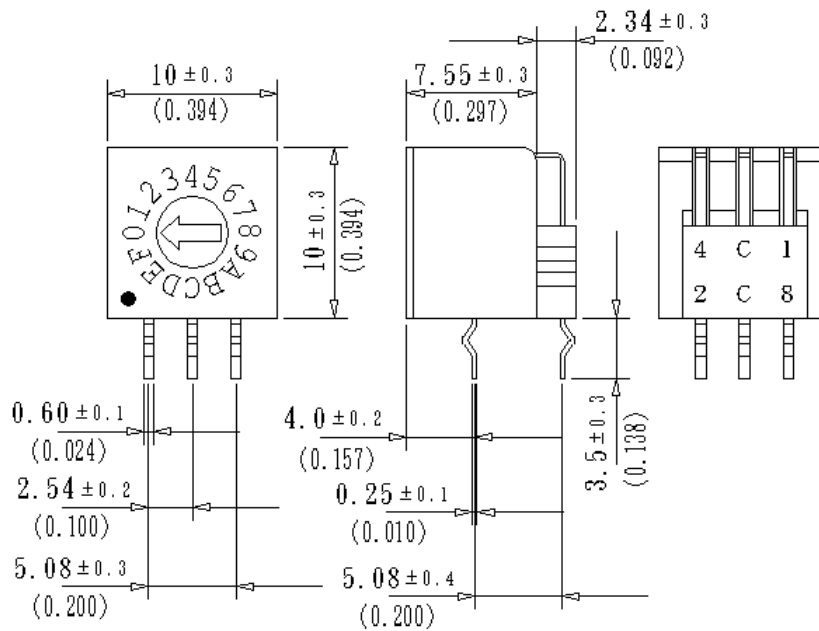

ERD2xxxF Shaft Type

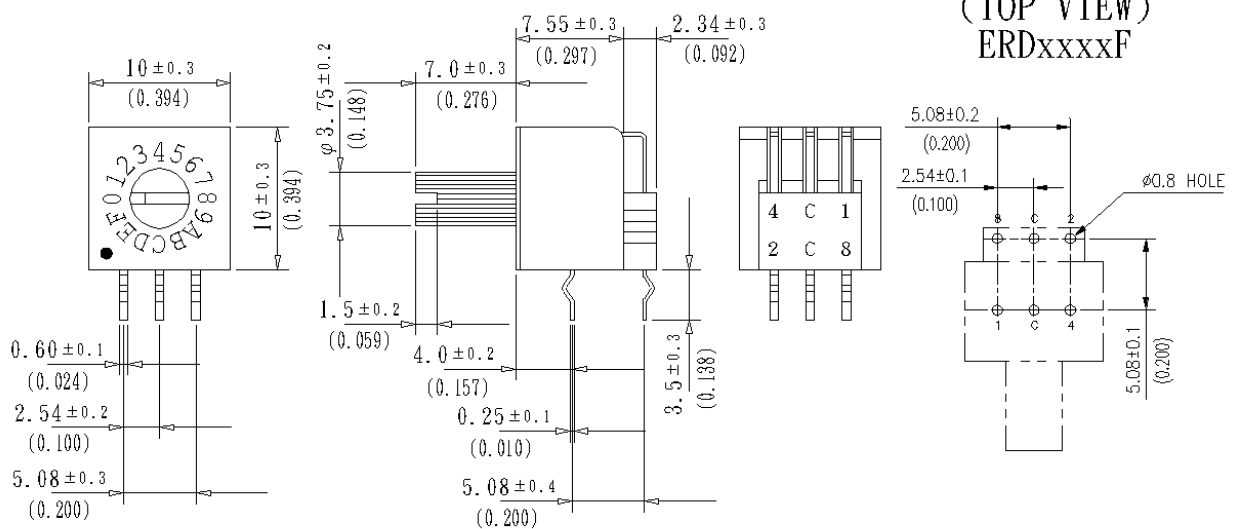

ERD1xxxM Flat Type

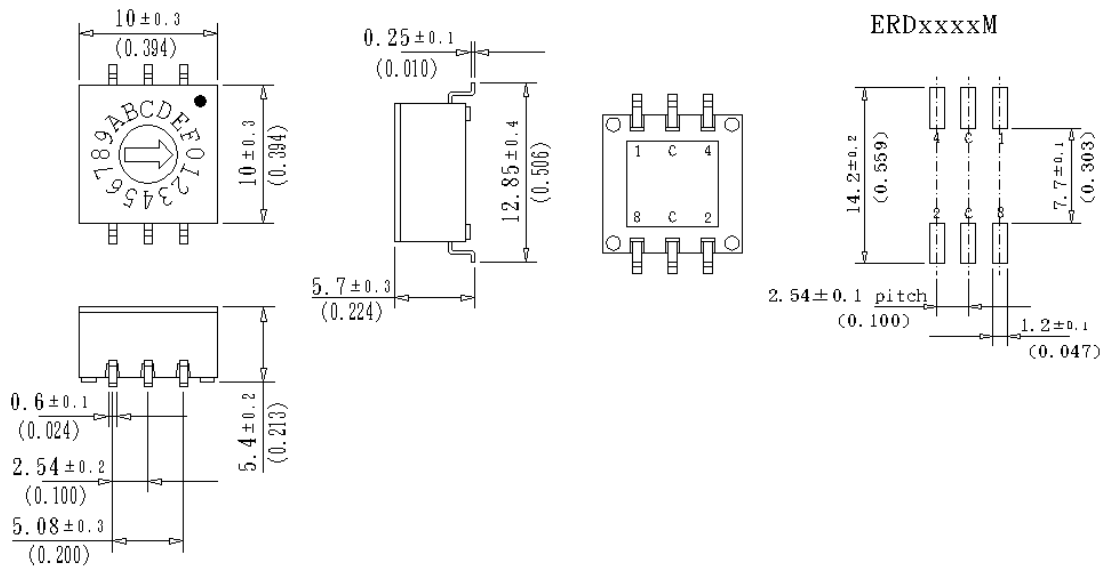

■ DIMENSIONS AND CIRCUITRY UNIT:mm(inch) PIN OUT 1:4

ERD4xxxS Flat Type

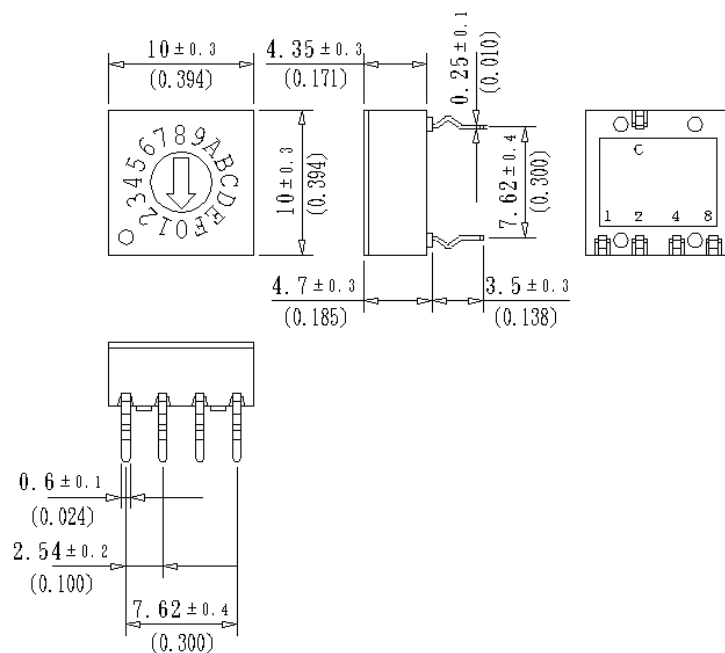

ERD5xxxS Shaft Type

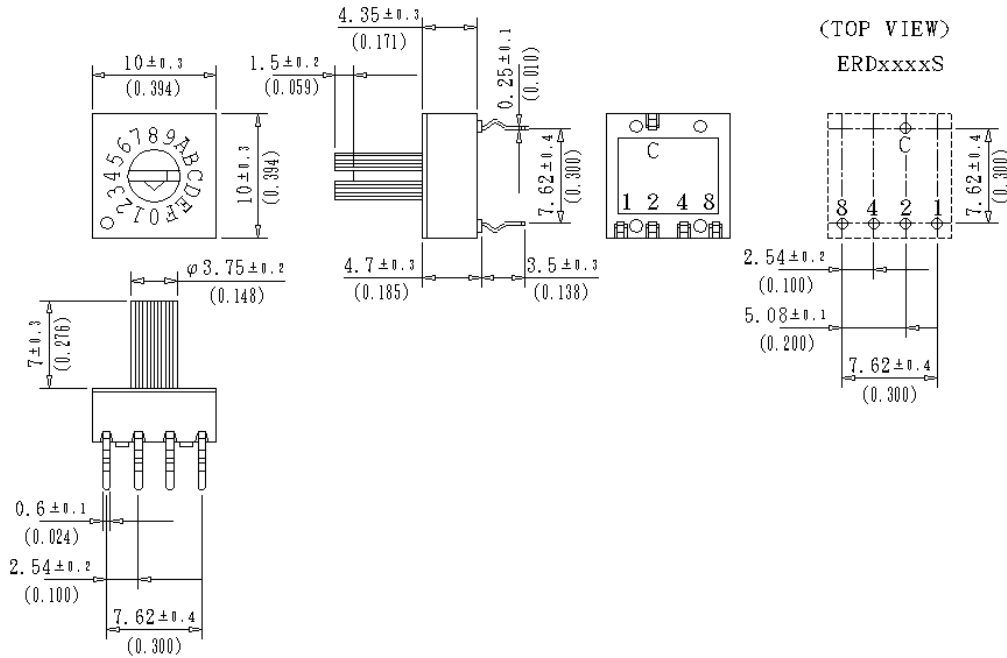

ERD4xxxR Flat Type

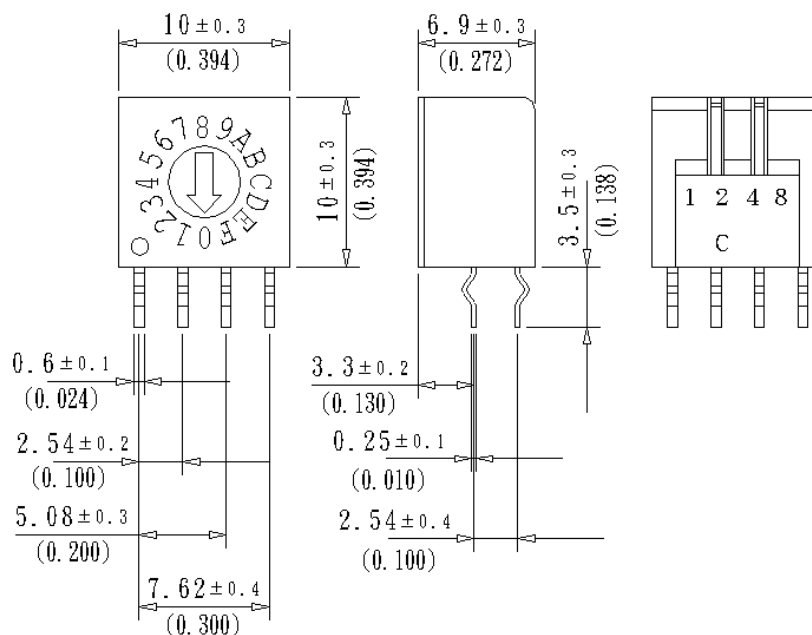

ERD5xxxR Shaft Type

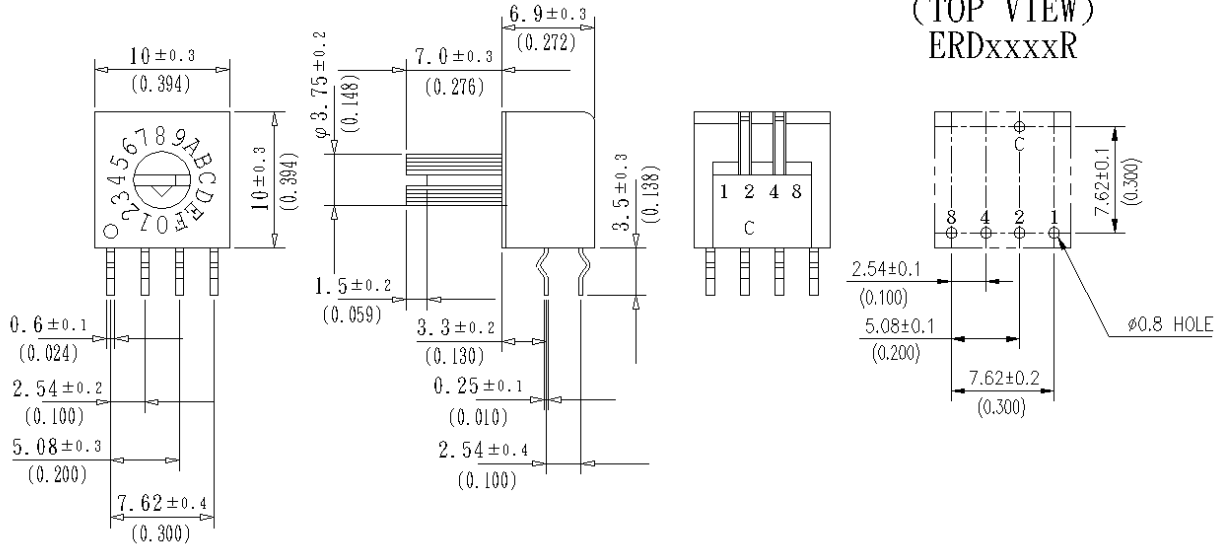

ERD4xxxF Flat Type

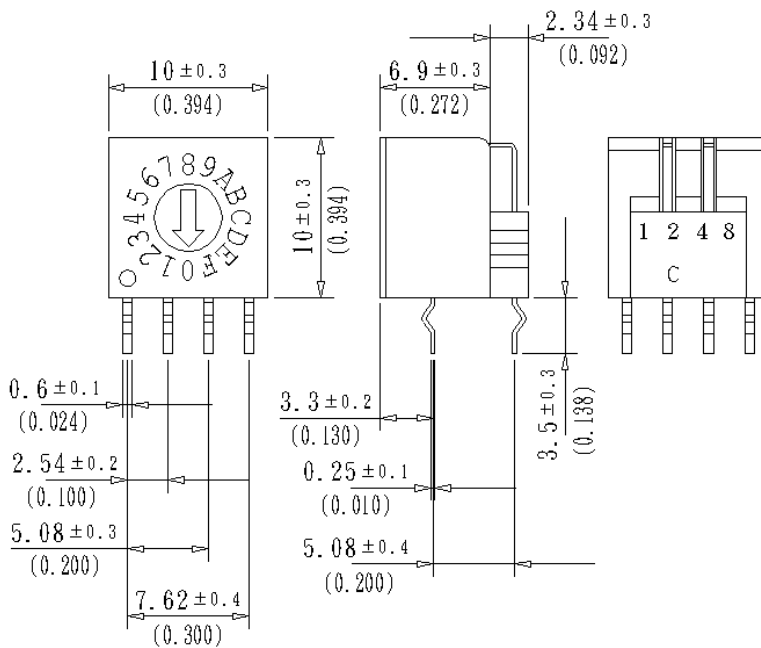

ERD5xxxF Shaft Type

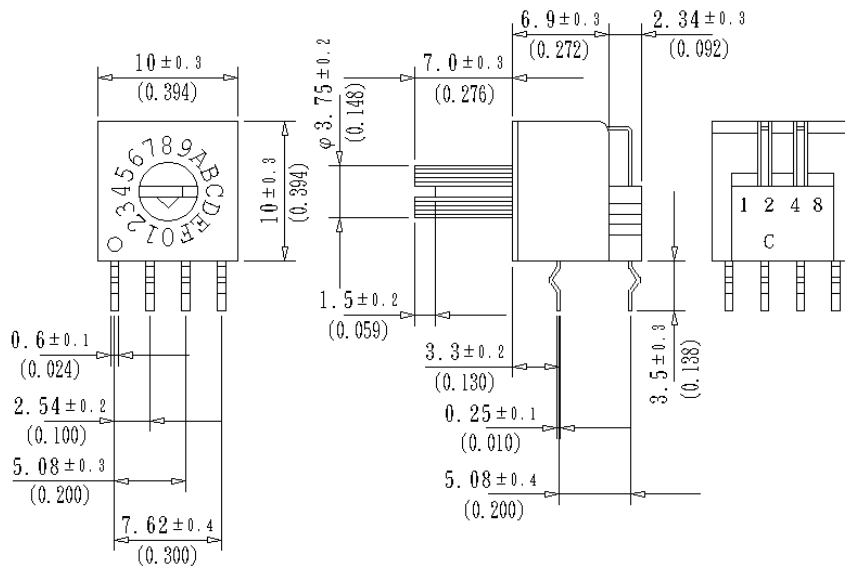

P. C. B LAYOUT (TOP VIEW) ERDxxxxF

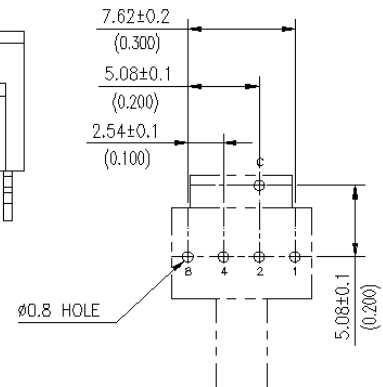

ERD4xxxM Flat Type

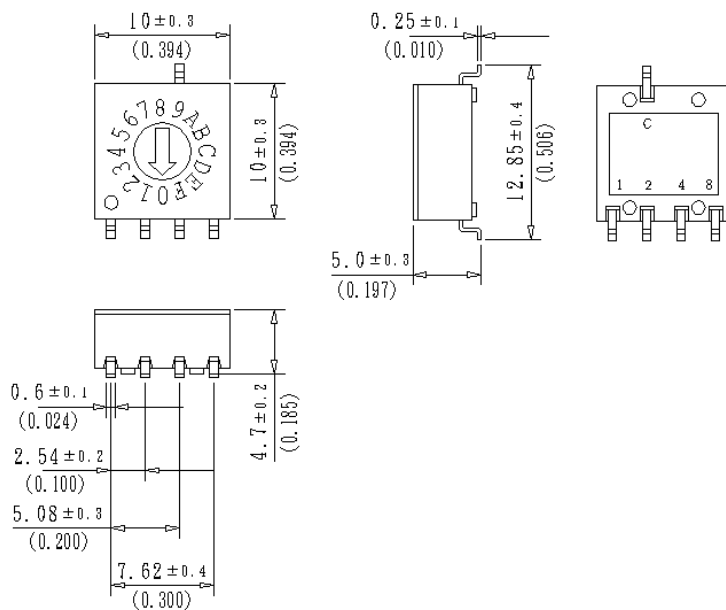

P. C. B LAYOUT (TOP VIEW) ERDxxxxM

