

# CD4094B Types

## CMOS 8-Stage Shift-and-Store Bus Register

High-Voltage Types (20-Volt Rating)

■ CD4094B is an 8-stage serial shift register having a storage latch associated with each stage for strobing data from the serial input to parallel buffered 3-state outputs. The parallel outputs may be connected directly to common bus lines. Data is shifted on positive clock transitions. The data in each shift register stage is transferred to the storage register when the STROBE input is high. Data in the storage register appears at the outputs whenever the OUTPUT-ENABLE signal is high.

Two serial outputs are available for cascading a number of CD4094B devices. Data is available at the Q<sub>S</sub> serial output terminal on positive clock edges to allow for high-speed operation in cascaded systems in which the clock rise time is fast. The same serial information, available at the Q<sub>S</sub> terminal on the next negative clock edge, provides a means for cascading CD4094B devices when the clock rise time is slow.

The CD4094B types are supplied in 16-lead hermetic dual-in-line ceramic packages (F3A suffix), 16-lead dual-in-line plastic packages (E suffix), 16-lead small-outline packages (NSR suffix), and 16-lead thin shrink small-outline packages (PW and PWR suffixes).

### Features:

- 3-state parallel outputs for connection to common bus
- Separate serial outputs synchronous to both positive and negative clock edges for cascading
- Medium speed operation - 5 MHz at 10 V (typ.)
- Standardized, symmetrical output characteristics
- 100% tested for quiescent current at 20 V
- Maximum input current of 1 μA at 18 V over full package-temperature range; 100 nA at 18 V and 25°C
- Noise margin (full package temperature range):  
1 V at V<sub>DD</sub> = 5 V      2 V at V<sub>DD</sub> = 10 V  
2.5 V at V<sub>DD</sub> = 15 V
- 5-V, 10-V, and 15-V parametric ratings
- Meets all requirements of JEDEC Tentative Standard No. 13B, "Standard Specifications for Description of 'B' Series CMOS Devices"

### Applications:

- Serial-to-parallel data conversion
- Remote control holding register
- Dual-rank shift, hold, and bus applications

### MAXIMUM RATINGS, Absolute-Maximum Values:

DC SUPPLY-VOLTAGE RANGE, (V <sub>DD</sub> )	-0.5V to +20V
Voltages referenced to V <sub>SS</sub> Terminal)	
INPUT VOLTAGE RANGE, ALL INPUTS	-0.5V to V <sub>DD</sub> + 0.5V
DC INPUT CURRENT, ANY ONE INPUT	±10mA
POWER DISSIPATION PER PACKAGE (P <sub>D</sub> ):	
For T <sub>A</sub> = -55°C to +100°C	500mW
For T <sub>A</sub> = +100°C to +125°C	Derate Linearly at 12mW/°C to 200mW
DEVICE DISSIPATION PER OUTPUT TRANSISTOR	
FOR T <sub>A</sub> = FULL PACKAGE-TEMPERATURE RANGE (All Package Types)	100mW
OPERATING-TEMPERATURE RANGE (T <sub>A</sub> )	-55°C to +125°C
STORAGE TEMPERATURE RANGE (T <sub>stg</sub> )	-65°C to +150°C
LEAD TEMPERATURE (DURING SOLDERING):	
At distance 1/16 ± 1/32 inch (1.59 ± 0.79mm) from case for 10s max	+265°C

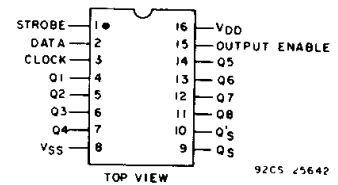
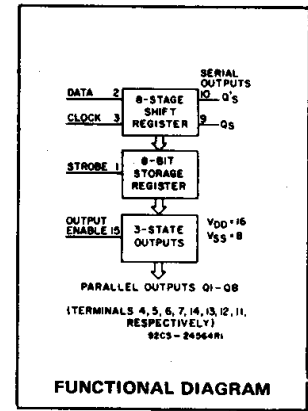

Fig. 1 - Terminal assignment.

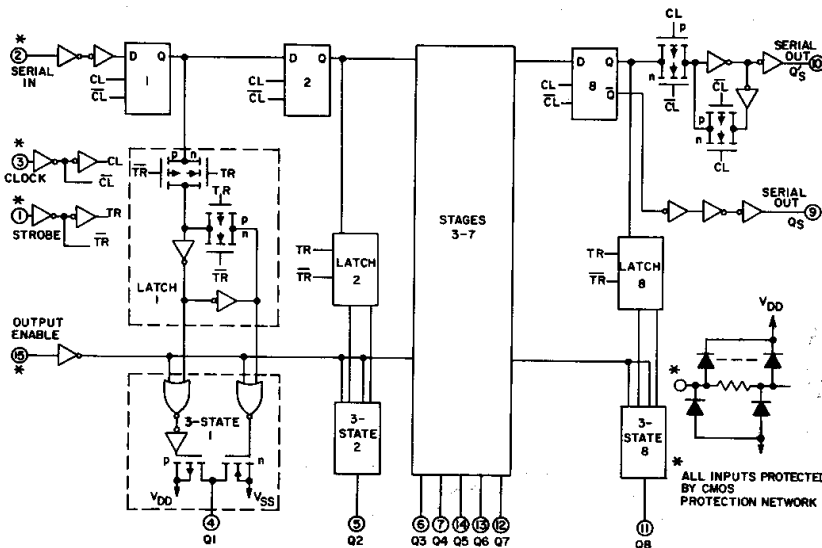

Fig. 2 - CD4094B Logic diagram.

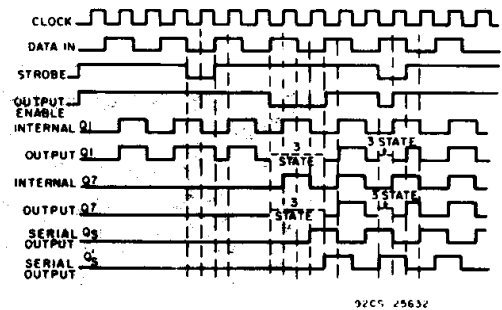

Fig. 3 - Timing diagram.

# CD4094B Types

**RECOMMENDED OPERATING CONDITIONS at  $T_A = 25^\circ\text{C}$ , Except as Noted.**  
 For maximum reliability, nominal operating conditions should be selected so that operation is always within the following ranges:

CHARACTERISTIC	VDD (V)	LIMITS		UNITS
		MIN.	MAX.	
Supply-Voltage Range (For $T_A$ =Full Package-Temperature Range)		3	18	V
Data Setup Time, $t_S$	5	125	—	ns
	10	55	—	
	15	35	—	
Clock Pulse Width, $t_W$	5	200	—	ns
	10	100	—	
	15	83	—	
Clock Input Frequency, $f_{CL}$	5		1.25	MHz
	10	dc	2.5	
	15		3	
Clock Input Rise or Fall time, $t_{rCL}, t_{fCL}$ *	5		15	$\mu\text{s}$
	10	—	5	
	15		5	
Strobe Pulse Width, $t_W$	5	200	—	ns
	10	80	—	
	15	70	—	

\*If more than one unit is cascaded  $t_{fCL}$  (for  $Q_S$  only) should be made less than or equal to the sum of the fixed propagation delay at 50 pF and the transition time of the output driving stage for the estimated capacitive load.

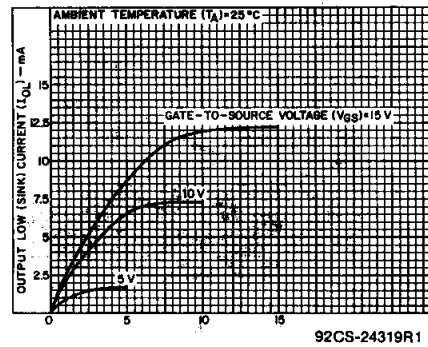

Fig. 5 - Minimum output low (sink) current characteristics.

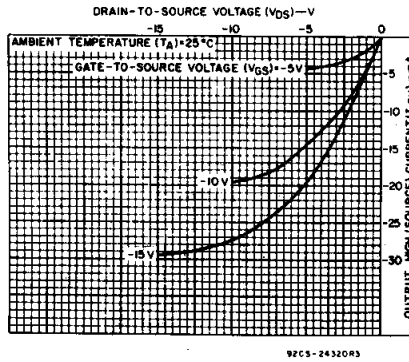

Fig. 6 - Typical output high (source) current characteristics.

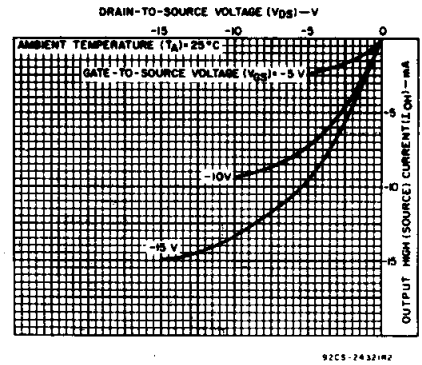

Fig. 7 - Minimum output high (source) current characteristics.

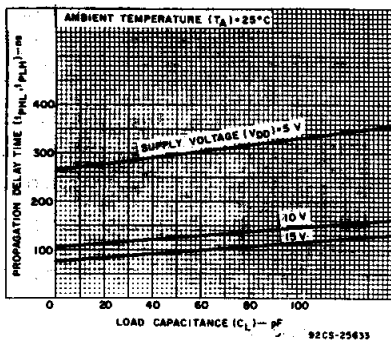

Fig. 8 - Clock-to-serial output  $Q_S$  propagation delay vs  $C_L$ .

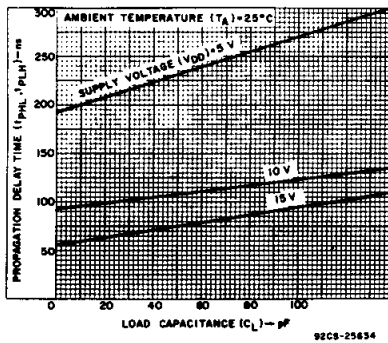

Fig. 9 - Clock-to-serial output  $Q'_S$  propagation delay vs  $C_L$ .

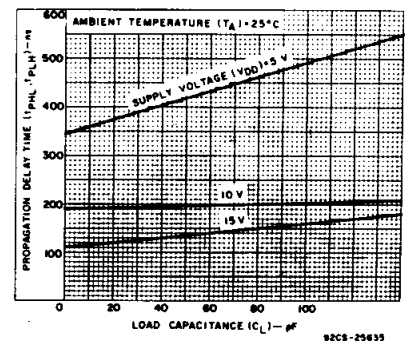

Fig. 10 - Clock-to-parallel output propagation delay vs  $C_L$ .

## TRUTH TABLE

CL <sup>▲</sup>	Output Enable	Strobe	Data	Parallel Outputs		Serial Outputs	
				Q1	Q2	Q3*	Q4
0	X	X	X	OC	OC	Q7	NC
0	X	X	X	OC	OC	NC	Q7
1	0	X	X	NC	NC	Q7	NC
1	1	0	0	Q <sub>N-1</sub>	Q <sub>N-1</sub>	Q7	NC
1	1	1	1	Q <sub>N-1</sub>	Q <sub>N-1</sub>	Q7	NC
1	1	1	1	NC	NC	NC	Q7

▲ = Level Change  
 X = Don't Care  
 NC = No Change  
 OC = Open Circuit  
 Logic 1  $\equiv$  High  
 Logic 0  $\equiv$  Low

\* At the positive clock edge information in the 7th shift register stage is transferred to the 8th register stage and the  $Q_S$  output.

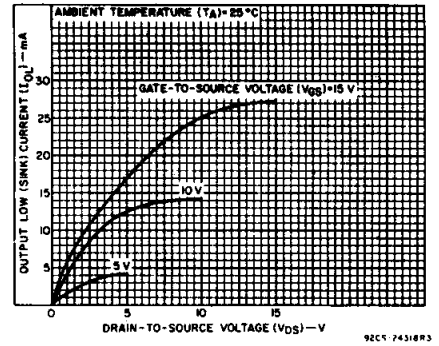

Fig. 4 - Typical output low (sink) current characteristics.

3  
 COMMERCIAL CMOS  
 HIGH VOLTAGE ICs

# CD4094B Types

## STATIC ELECTRICAL CHARACTERISTICS

CHARACTERISTIC	CONDITIONS			LIMITS AT INDICATED TEMPERATURES (°C)							UNITS
	V <sub>O</sub> (V)	V <sub>IN</sub> (V)	V <sub>DD</sub> (V)	-55	-40	+85	+125	+25			
								Min.	Typ.	Max.	
Quiescent Device Current, I <sub>DD</sub> Max.	-	0.5	5	5	5	150	150	-	0.04	5	μA
	-	0.10	10	10	10	300	300	-	0.04	10	
	-	0.15	15	20	20	600	600	-	0.04	20	
	-	0.20	20	100	100	3000	3000	-	0.08	100	
Output Low (Sink) Current, I <sub>OL</sub> Min.	0.4	0.5	5	0.64	0.61	0.42	0.36	0.51	1	-	mA
	0.5	0.10	10	1.6	1.5	1.1	0.9	1.3	2.6	-	
	1.5	0.15	15	4.2	4	2.8	2.4	3.4	6.8	-	
Output High (Source) Current, I <sub>OH</sub> Min.	4.6	0.5	5	-0.64	-0.61	-0.42	-0.36	-0.51	-1	-	mA
	2.5	0.5	5	-2	-1.8	-1.3	-1.15	-1.6	-3.2	-	
	9.5	0.10	10	-1.6	-1.5	-1.1	-0.9	-1.3	-2.6	-	
	13.5	0.15	15	-4.2	-4	-2.8	-2.4	-3.4	-6.8	-	
Output Voltage: Low-Level, V <sub>OL</sub> Max.	-	0.5	5	0.05				-	0	0.05	V
	-	0.10	10	0.05				-	0	0.05	
	-	0.15	15	0.05				-	0	0.05	
Output Voltage: High-Level, V <sub>OH</sub> Min.	-	0.5	5	4.95				4.95	5	-	V
	-	0.10	10	9.95				9.95	10	-	
	-	0.15	15	14.95				14.95	15	-	
Input Low Voltage, V <sub>IL</sub> Max.	0.5, 4.5	-	5	1.5				-	-	1.5	V
	1.9	-	10	3				-	-	3	
	1.5, 13.5	-	15	4				-	-	4	
Input High Voltage, V <sub>IH</sub> Min.	0.5, 4.5	-	5	3.5				3.5	-	-	V
	1.9	-	10	7				7	-	-	
	1.5, 13.5	-	15	11				11	-	-	
Input Current I <sub>IN</sub> Max.	-	0.18	18	±0.1	±0.1	±1	±1	-	±10 <sup>-5</sup>	±0.1	μA
3-State Output Leakage Current I <sub>OUT</sub> Max.	0.18	0.18	18	±0.4	±0.4	±12	±12	-	±10 <sup>-4</sup>	±0.4	μA

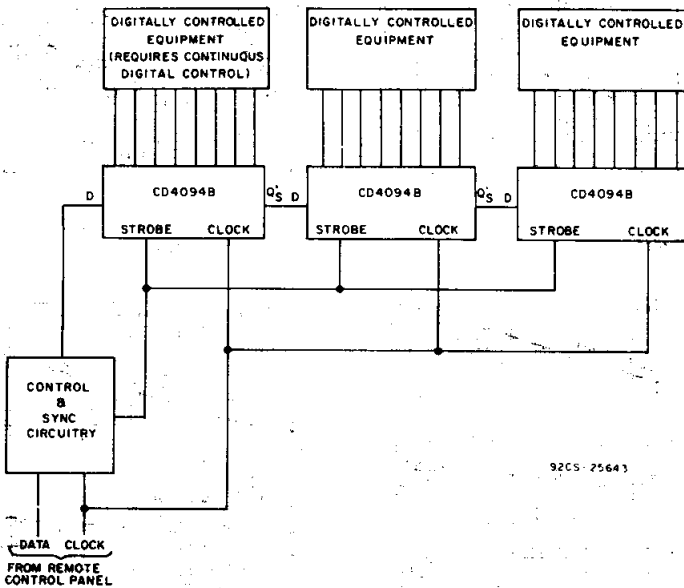

Fig. 14 - Remote control holding register.

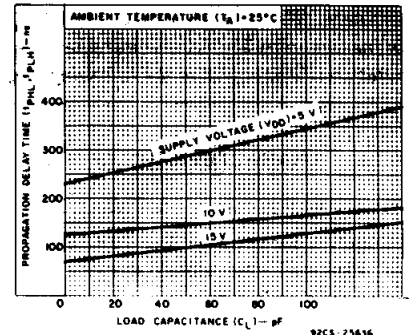

Fig. 11 - Strobe-to-parallel output propagation delay vs. C<sub>L</sub>.

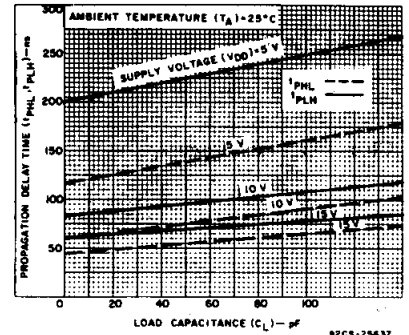

Fig. 12 - Output enable-to-parallel output propagation delay vs. C<sub>L</sub>.

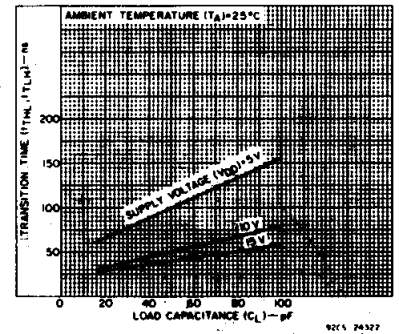

Fig. 13 - Typical transition time vs. load capacitance.

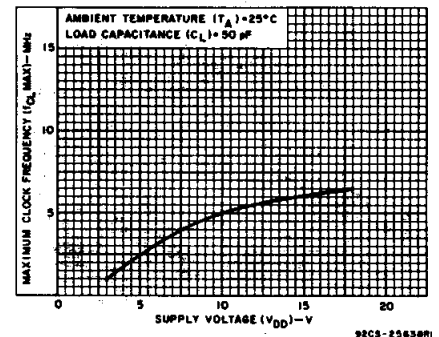

Fig. 15 - Typical maximum-clock-frequency vs. supply voltage.

# CD4094B Types

## DYNAMIC ELECTRICAL CHARACTERISTICS

At  $T_A = 25^\circ\text{C}$ ; Input  $t_r, t_f = 20\text{ ns}$ ,  $C_L = 50\text{ pF}$ ,  $R_L = 200\text{ k}\Omega$

CHARACTERISTIC	VDD (V)	LIMITS			UNITS
		MIN.	TYP.	MAX.	
Propagation Delay Time, $t_{PHL}, t_{PLH}$ Clock to Serial Output $Q_S$	5	—	300	600	ns
	10	—	125	250	
	15	—	95	190	
Clock to Serial Output $Q'_S$	5	—	230	460	ns
	10	—	110	220	
	15	—	75	150	
Clock to Parallel Output	5	—	420	840	ns
	10	—	195	390	
	15	—	135	270	
Strobe to Parallel Output	5	—	290	580	ns
	10	—	145	290	
	15	—	100	200	
Output Enable to Parallel Output: $t_{PHZ}, t_{PZH}$	5	—	140	280	ns
	10	—	60	120	
	15	—	45	90	
$t_{PLZ}, t_{PZL}$	5	—	100	200	ns
	10	—	50	100	
	15	—	40	80	
Minimum Strobe Pulse Width, $t_W$	5	—	100	200	ns
	10	—	40	80	
	15	—	35	70	
Minimum Clock Pulse Width, $t_W$	5	—	100	200	ns
	10	—	50	100	
	15	—	40	83	
Minimum Data Setup Time, $t_S$	5	—	60	125	ns
	10	—	30	55	
	15	—	20	35	
Transition Time; $t_{THL}, t_{TLH}$	5	—	100	200	ns
	10	—	50	100	
	15	—	40	80	
Maximum Clock Input Rise or Fall Time, $t_{rCL}, t_{fCL}$	5	15	—	—	$\mu\text{s}$
	10	5	—	—	
	15	5	—	—	
Maximum Clock Input Frequency, $f_{CL}$	5	1.25	2.5	—	MHz
	10	2.5	5	—	
	15	3	6	—	
Input Capacitance $C_{iN}$ (Any Input)	—	—	5	7.5	pF

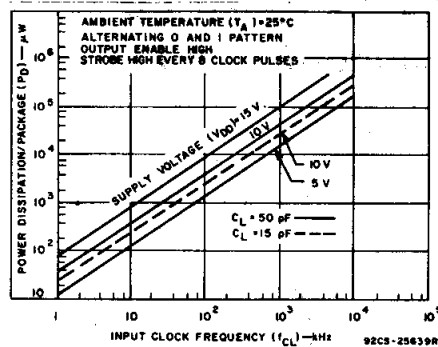

Fig. 16 — Dynamic power dissipation vs input clock frequency.

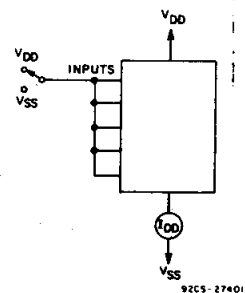

Fig. 17 — Quiescent device current test circuit.

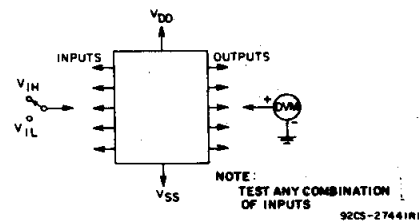

Fig. 18 — Input voltage test circuit.

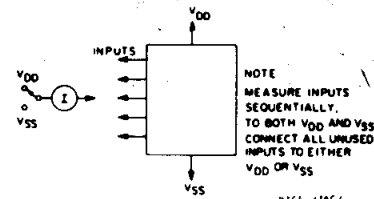
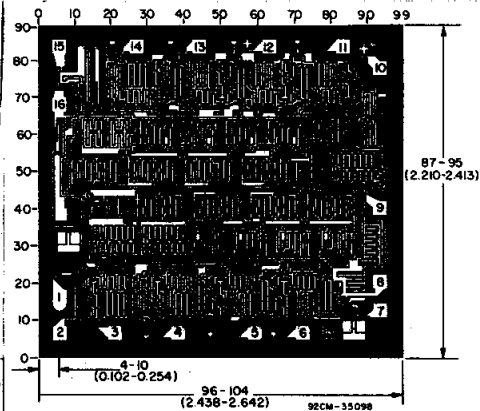

Fig. 19 — Input current test circuit.



Dimensions and Pad Layout for CD4094B Chip.

Dimensions in parentheses are in millimeters and are derived from the basic inch dimensions as indicated. Grid graduations are in mils ( $10^{-3}$  inch).

3  
COMMERCIAL CMOS  
HIGH VOLTAGE ICs

**PACKAGING INFORMATION**

Orderable Device	Status (1)	Package Type	Package Drawing	Pins	Package Qty	Eco Plan (2)	Lead/Ball Finish	MSL Peak Temp (3)	Op Temp (°C)	Top-Side Markings (4)	Samples
7702501EA	ACTIVE	CDIP	J	16	1	TBD	Call TI	Call TI	-55 to 125	7702501EA CD4094BF3A	<a href="#">Samples</a>
CD4094BE	ACTIVE	PDIP	N	16	25	Pb-Free (RoHS)	CU NIPDAU	N / A for Pkg Type	-55 to 125	CD4094BE	<a href="#">Samples</a>
CD4094BEE4	ACTIVE	PDIP	N	16	25	Pb-Free (RoHS)	CU NIPDAU	N / A for Pkg Type	-55 to 125	CD4094BE	<a href="#">Samples</a>
CD4094BF	ACTIVE	CDIP	J	16	1	TBD	A42	N / A for Pkg Type	-55 to 125	CD4094BF	<a href="#">Samples</a>
CD4094BF3A	ACTIVE	CDIP	J	16	1	TBD	A42	N / A for Pkg Type	-55 to 125	7702501EA CD4094BF3A	<a href="#">Samples</a>
CD4094BNSR	ACTIVE	SO	NS	16	2000	Green (RoHS & no Sb/Br)	CU NIPDAU	Level-1-260C-UNLIM	-55 to 125	CD4094B	<a href="#">Samples</a>
CD4094BNSRE4	ACTIVE	SO	NS	16	2000	Green (RoHS & no Sb/Br)	CU NIPDAU	Level-1-260C-UNLIM	-55 to 125	CD4094B	<a href="#">Samples</a>
CD4094BNSRG4	ACTIVE	SO	NS	16	2000	Green (RoHS & no Sb/Br)	CU NIPDAU	Level-1-260C-UNLIM	-55 to 125	CD4094B	<a href="#">Samples</a>
CD4094BPW	ACTIVE	TSSOP	PW	16	90	Green (RoHS & no Sb/Br)	CU NIPDAU	Level-1-260C-UNLIM	-55 to 125	CM094B	<a href="#">Samples</a>
CD4094BPWE4	ACTIVE	TSSOP	PW	16	90	Green (RoHS & no Sb/Br)	CU NIPDAU	Level-1-260C-UNLIM	-55 to 125	CM094B	<a href="#">Samples</a>
CD4094BPWG4	ACTIVE	TSSOP	PW	16	90	Green (RoHS & no Sb/Br)	CU NIPDAU	Level-1-260C-UNLIM	-55 to 125	CM094B	<a href="#">Samples</a>
CD4094BPWR	ACTIVE	TSSOP	PW	16	2000	Green (RoHS & no Sb/Br)	CU NIPDAU	Level-1-260C-UNLIM	-55 to 125	CM094B	<a href="#">Samples</a>
CD4094BPWRE4	ACTIVE	TSSOP	PW	16	2000	Green (RoHS & no Sb/Br)	CU NIPDAU	Level-1-260C-UNLIM	-55 to 125	CM094B	<a href="#">Samples</a>
CD4094BPWRG4	ACTIVE	TSSOP	PW	16	2000	Green (RoHS & no Sb/Br)	CU NIPDAU	Level-1-260C-UNLIM	-55 to 125	CM094B	<a href="#">Samples</a>

(1) The marketing status values are defined as follows:

**ACTIVE:** Product device recommended for new designs.

**LIFEBUY:** TI has announced that the device will be discontinued, and a lifetime-buy period is in effect.

**NRND:** Not recommended for new designs. Device is in production to support existing customers, but TI does not recommend using this part in a new design.

**PREVIEW:** Device has been announced but is not in production. Samples may or may not be available.

**OBSOLETE:** TI has discontinued the production of the device.

<sup>(2)</sup> Eco Plan - The planned eco-friendly classification: Pb-Free (RoHS), Pb-Free (RoHS Exempt), or Green (RoHS & no Sb/Br) - please check <http://www.ti.com/productcontent> for the latest availability information and additional product content details.

**TBD:** The Pb-Free/Green conversion plan has not been defined.

**Pb-Free (RoHS):** TI's terms "Lead-Free" or "Pb-Free" mean semiconductor products that are compatible with the current RoHS requirements for all 6 substances, including the requirement that lead not exceed 0.1% by weight in homogeneous materials. Where designed to be soldered at high temperatures, TI Pb-Free products are suitable for use in specified lead-free processes.

**Pb-Free (RoHS Exempt):** This component has a RoHS exemption for either 1) lead-based flip-chip solder bumps used between the die and package, or 2) lead-based die adhesive used between the die and leadframe. The component is otherwise considered Pb-Free (RoHS compatible) as defined above.

**Green (RoHS & no Sb/Br):** TI defines "Green" to mean Pb-Free (RoHS compatible), and free of Bromine (Br) and Antimony (Sb) based flame retardants (Br or Sb do not exceed 0.1% by weight in homogeneous material)

<sup>(3)</sup> MSL, Peak Temp. -- The Moisture Sensitivity Level rating according to the JEDEC industry standard classifications, and peak solder temperature.

<sup>(4)</sup> Only one of markings shown within the brackets will appear on the physical device.

**Important Information and Disclaimer:** The information provided on this page represents TI's knowledge and belief as of the date that it is provided. TI bases its knowledge and belief on information provided by third parties, and makes no representation or warranty as to the accuracy of such information. Efforts are underway to better integrate information from third parties. TI has taken and continues to take reasonable steps to provide representative and accurate information but may not have conducted destructive testing or chemical analysis on incoming materials and chemicals. TI and TI suppliers consider certain information to be proprietary, and thus CAS numbers and other limited information may not be available for release.

In no event shall TI's liability arising out of such information exceed the total purchase price of the TI part(s) at issue in this document sold by TI to Customer on an annual basis.

**OTHER QUALIFIED VERSIONS OF CD4094B, CD4094B-MIL :**

● Catalog: [CD4094B](#)

● Military: [CD4094B-MIL](#)

NOTE: Qualified Version Definitions:

● Catalog - TI's standard catalog product

● Military - QML certified for Military and Defense Applications

## TAPE AND REEL INFORMATION



### QUADRANT ASSIGNMENTS FOR PIN 1 ORIENTATION IN TAPE



\*All dimensions are nominal

Device	Package Type	Package Drawing	Pins	SPQ	Reel Diameter (mm)	Reel Width W1 (mm)	A0 (mm)	B0 (mm)	K0 (mm)	P1 (mm)	W (mm)	Pin1 Quadrant
CD4094BPWR	TSSOP	PW	16	2000	330.0	12.4	6.9	5.6	1.6	8.0	12.0	Q1

**TAPE AND REEL BOX DIMENSIONS**



\*All dimensions are nominal

Device	Package Type	Package Drawing	Pins	SPQ	Length (mm)	Width (mm)	Height (mm)
CD4094BPWR	TSSOP	PW	16	2000	367.0	367.0	35.0



J (R-GDIP-T\*\*)

14 LEADS SHOWN

CERAMIC DUAL IN-LINE PACKAGE



DIM \ PINS **	14	16	18	20
A	0.300 (7,62) BSC	0.300 (7,62) BSC	0.300 (7,62) BSC	0.300 (7,62) BSC
B MAX	0.785 (19,94)	.840 (21,34)	0.960 (24,38)	1.060 (26,92)
B MIN	—	—	—	—
C MAX	0.300 (7,62)	0.300 (7,62)	0.310 (7,87)	0.300 (7,62)
C MIN	0.245 (6,22)	0.245 (6,22)	0.220 (5,59)	0.245 (6,22)



4040083/F 03/03

- NOTES:
- All linear dimensions are in inches (millimeters).
  - This drawing is subject to change without notice.
  - This package is hermetically sealed with a ceramic lid using glass frit.
  - Index point is provided on cap for terminal identification only on press ceramic glass frit seal only.
  - Falls within MIL STD 1835 GDIP1-T14, GDIP1-T16, GDIP1-T18 and GDIP1-T20.

N (R-PDIP-T\*\*)

PLASTIC DUAL-IN-LINE PACKAGE

16 PINS SHOWN



- NOTES:
- A. All linear dimensions are in inches (millimeters).
  - B. This drawing is subject to change without notice.
  - C Falls within JEDEC MS-001, except 18 and 20 pin minimum body length (Dim A).
  - D The 20 pin end lead shoulder width is a vendor option, either half or full width.



4040049/E 12/2002

PW (R-PDSO-G16)

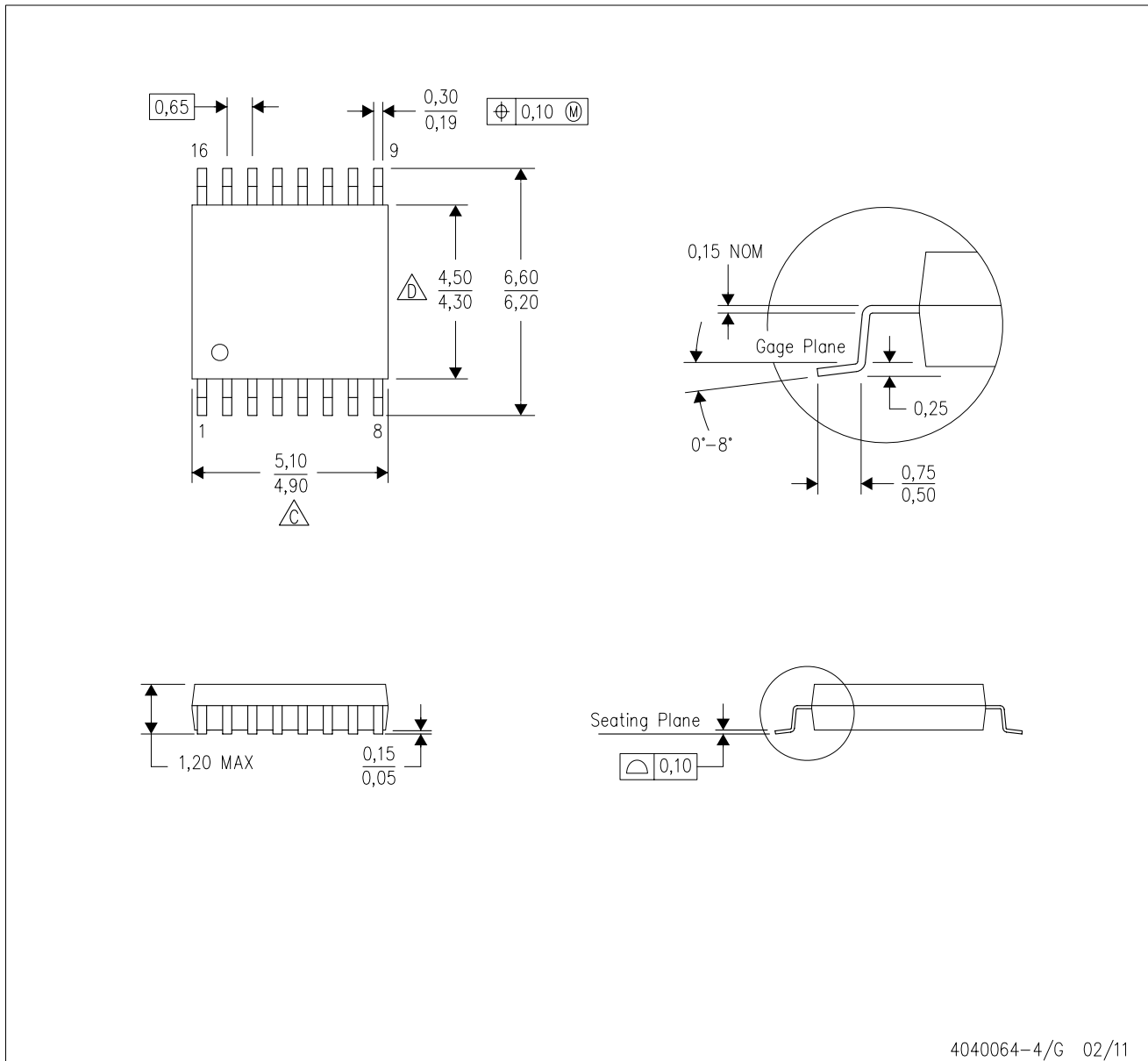
PLASTIC SMALL OUTLINE



4040064-4/G 02/11

- NOTES:
- A. All linear dimensions are in millimeters. Dimensioning and tolerancing per ASME Y14.5M-1994.
  - B. This drawing is subject to change without notice.
  -  Body length does not include mold flash, protrusions, or gate burrs. Mold flash, protrusions, or gate burrs shall not exceed 0,15 each side.
  -  Body width does not include interlead flash. Interlead flash shall not exceed 0,25 each side.
  - E. Falls within JEDEC MO-153

PW (R-PDSO-G16)

PLASTIC SMALL OUTLINE

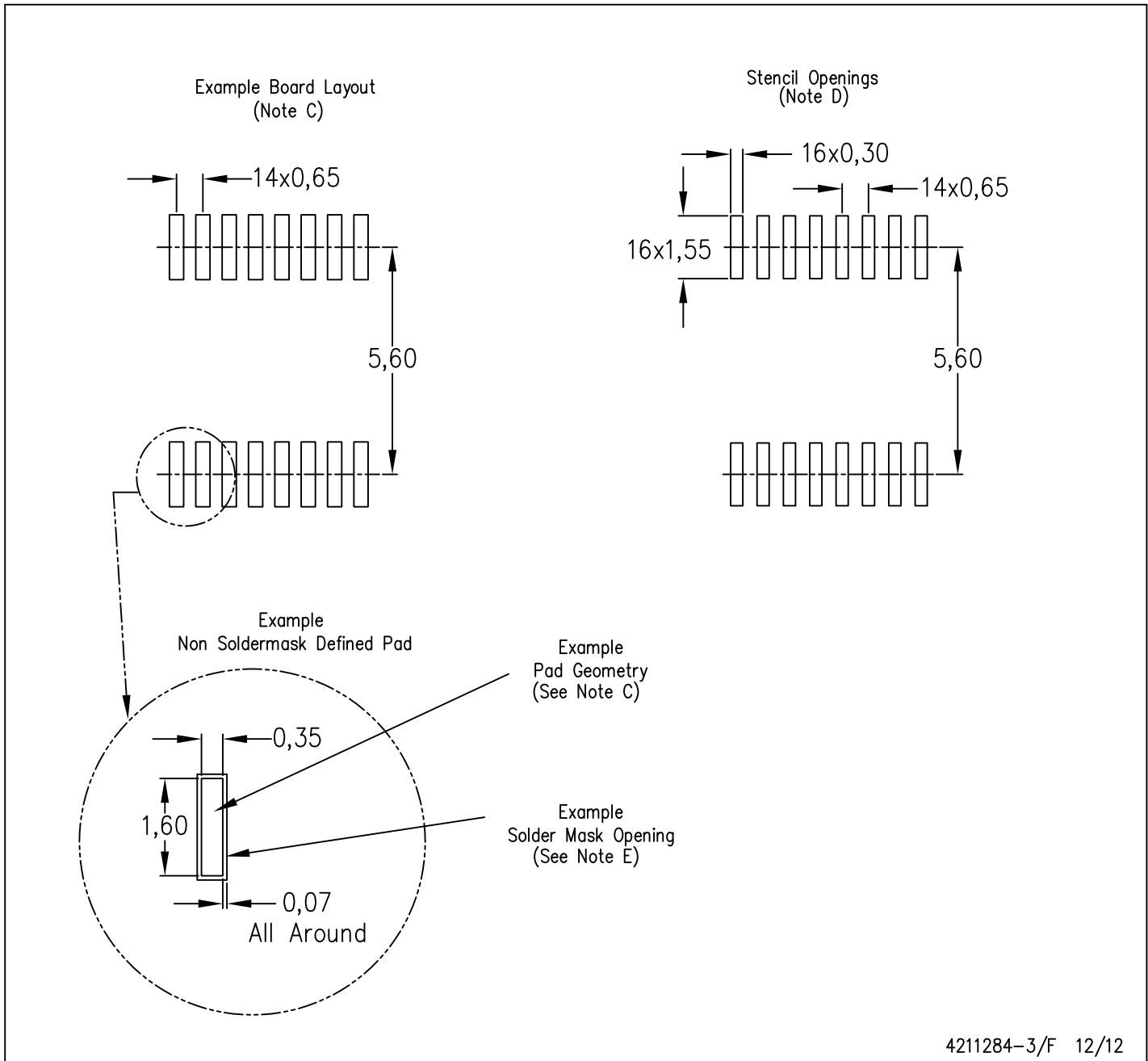

- NOTES:
- All linear dimensions are in millimeters.
  - This drawing is subject to change without notice.
  - Publication IPC-7351 is recommended for alternate designs.
  - Laser cutting apertures with trapezoidal walls and also rounding corners will offer better paste release. Customers should contact their board assembly site for stencil design recommendations. Refer to IPC-7525 for other stencil recommendations.
  - Customers should contact their board fabrication site for solder mask tolerances between and around signal pads.

# MECHANICAL DATA

NS (R-PDSO-G\*\*)

PLASTIC SMALL-OUTLINE PACKAGE

14-PINS SHOWN



- NOTES:
- A. All linear dimensions are in millimeters.
  - B. This drawing is subject to change without notice.
  - C. Body dimensions do not include mold flash or protrusion, not to exceed 0,15.

## IMPORTANT NOTICE

Texas Instruments Incorporated and its subsidiaries (TI) reserve the right to make corrections, enhancements, improvements and other changes to its semiconductor products and services per JESD46, latest issue, and to discontinue any product or service per JESD48, latest issue. Buyers should obtain the latest relevant information before placing orders and should verify that such information is current and complete. All semiconductor products (also referred to herein as "components") are sold subject to TI's terms and conditions of sale supplied at the time of order acknowledgment.

TI warrants performance of its components to the specifications applicable at the time of sale, in accordance with the warranty in TI's terms and conditions of sale of semiconductor products. Testing and other quality control techniques are used to the extent TI deems necessary to support this warranty. Except where mandated by applicable law, testing of all parameters of each component is not necessarily performed.

TI assumes no liability for applications assistance or the design of Buyers' products. Buyers are responsible for their products and applications using TI components. To minimize the risks associated with Buyers' products and applications, Buyers should provide adequate design and operating safeguards.

TI does not warrant or represent that any license, either express or implied, is granted under any patent right, copyright, mask work right, or other intellectual property right relating to any combination, machine, or process in which TI components or services are used. Information published by TI regarding third-party products or services does not constitute a license to use such products or services or a warranty or endorsement thereof. Use of such information may require a license from a third party under the patents or other intellectual property of the third party, or a license from TI under the patents or other intellectual property of TI.

Reproduction of significant portions of TI information in TI data books or data sheets is permissible only if reproduction is without alteration and is accompanied by all associated warranties, conditions, limitations, and notices. TI is not responsible or liable for such altered documentation. Information of third parties may be subject to additional restrictions.

Resale of TI components or services with statements different from or beyond the parameters stated by TI for that component or service voids all express and any implied warranties for the associated TI component or service and is an unfair and deceptive business practice. TI is not responsible or liable for any such statements.

Buyer acknowledges and agrees that it is solely responsible for compliance with all legal, regulatory and safety-related requirements concerning its products, and any use of TI components in its applications, notwithstanding any applications-related information or support that may be provided by TI. Buyer represents and agrees that it has all the necessary expertise to create and implement safeguards which anticipate dangerous consequences of failures, monitor failures and their consequences, lessen the likelihood of failures that might cause harm and take appropriate remedial actions. Buyer will fully indemnify TI and its representatives against any damages arising out of the use of any TI components in safety-critical applications.

In some cases, TI components may be promoted specifically to facilitate safety-related applications. With such components, TI's goal is to help enable customers to design and create their own end-product solutions that meet applicable functional safety standards and requirements. Nonetheless, such components are subject to these terms.

No TI components are authorized for use in FDA Class III (or similar life-critical medical equipment) unless authorized officers of the parties have executed a special agreement specifically governing such use.

Only those TI components which TI has specifically designated as military grade or "enhanced plastic" are designed and intended for use in military/aerospace applications or environments. Buyer acknowledges and agrees that any military or aerospace use of TI components which have **not** been so designated is solely at the Buyer's risk, and that Buyer is solely responsible for compliance with all legal and regulatory requirements in connection with such use.

TI has specifically designated certain components as meeting ISO/TS16949 requirements, mainly for automotive use. In any case of use of non-designated products, TI will not be responsible for any failure to meet ISO/TS16949.

### Products

Audio	<a href="http://www.ti.com/audio">www.ti.com/audio</a>
Amplifiers	<a href="http://amplifier.ti.com">amplifier.ti.com</a>
Data Converters	<a href="http://dataconverter.ti.com">dataconverter.ti.com</a>
DLP® Products	<a href="http://www.dlp.com">www.dlp.com</a>
DSP	<a href="http://dsp.ti.com">dsp.ti.com</a>
Clocks and Timers	<a href="http://www.ti.com/clocks">www.ti.com/clocks</a>
Interface	<a href="http://interface.ti.com">interface.ti.com</a>
Logic	<a href="http://logic.ti.com">logic.ti.com</a>
Power Mgmt	<a href="http://power.ti.com">power.ti.com</a>
Microcontrollers	<a href="http://microcontroller.ti.com">microcontroller.ti.com</a>
RFID	<a href="http://www.ti-rfid.com">www.ti-rfid.com</a>
OMAP Applications Processors	<a href="http://www.ti.com/omap">www.ti.com/omap</a>
Wireless Connectivity	<a href="http://www.ti.com/wirelessconnectivity">www.ti.com/wirelessconnectivity</a>

### Applications

Automotive and Transportation	<a href="http://www.ti.com/automotive">www.ti.com/automotive</a>
Communications and Telecom	<a href="http://www.ti.com/communications">www.ti.com/communications</a>
Computers and Peripherals	<a href="http://www.ti.com/computers">www.ti.com/computers</a>
Consumer Electronics	<a href="http://www.ti.com/consumer-apps">www.ti.com/consumer-apps</a>
Energy and Lighting	<a href="http://www.ti.com/energy">www.ti.com/energy</a>
Industrial	<a href="http://www.ti.com/industrial">www.ti.com/industrial</a>
Medical	<a href="http://www.ti.com/medical">www.ti.com/medical</a>
Security	<a href="http://www.ti.com/security">www.ti.com/security</a>
Space, Avionics and Defense	<a href="http://www.ti.com/space-avionics-defense">www.ti.com/space-avionics-defense</a>
Video and Imaging	<a href="http://www.ti.com/video">www.ti.com/video</a>

### TI E2E Community

[e2e.ti.com](http://e2e.ti.com)

# Mouser Electronics

Authorized Distributor

Click to View Pricing, Inventory, Delivery & Lifecycle Information:

## Texas Instruments:

[CD4094BE](#) [CD4094BPWR](#) [CD4094BPWG4](#) [CD4094BPWRG4](#) [CD4094BNSRG4](#) [CD4094BEE4](#) [CD4094BNSR](#)  
[CD4094BNSRE4](#) [CD4094BPW](#) [CD4094BPWE4](#) [CD4094BPWRE4](#)