

# Surface-Mount TRANSZORB® Transient Voltage Suppressors

**SMB (DO-214AA)**

## LINKS TO ADDITIONAL RESOURCES

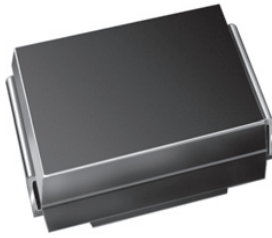
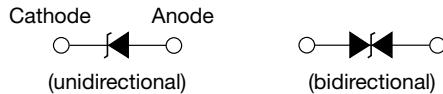

PRIMARY CHARACTERISTICS	
$V_{BR}$ (bidirectional)	6.4 V to 231 V
$V_{BR}$ (unidirectional)	6.4 V to 231 V
$V_{WM}$	5.0 V to 188 V
$P_{PPM}$	600 W
$P_D$	5.0 W
$I_{FSM}$ (unidirectional only)	100 A
$T_J$ max.	150 °C
Polarity	Unidirectional, bidirectional
Package	SMB (DO-214AA)

## DEVICES FOR BIDIRECTION APPLICATIONS

For bidirectional devices use CA suffix (e.g. SMBJ10CA).  
Electrical characteristics apply in both directions.

## TYPICAL APPLICATIONS

Use in sensitive electronics protection against voltage transients induced by inductive load switching and lighting on ICs, MOSFET, signal lines of sensor units for consumer, computer, industrial, and telecommunication.

## FEATURES

- Low profile package
- Ideal for automated placement
- Glass passivated chip junction
- Available in unidirectional and bidirectional
- 600 W peak pulse power capability with a 10/1000  $\mu$ s waveform, repetitive rate (duty cycle): 0.01 %
- Excellent clamping capability
- Very fast response time
- Low incremental surge resistance
- Meets MSL level 1, per J-STD-020, LF maximum peak of 260 °C
- AEC-Q101 qualified available
  - Automotive ordering code: base P/NHE3 or P/NHM3
- Material categorization: for definitions of compliance please see [www.vishay.com/doc?99912](http://www.vishay.com/doc?99912)



## MECHANICAL DATA

**Case:** SMB (DO-214AA)

Molding compound meets UL 94 V-0 flammability rating  
Base P/N-E3 - RoHS-compliant, commercial grade  
Base P/N-M3 - halogen-free, RoHS-compliant, commercial grade  
Base P/NHE3\_X - RoHS-compliant and AEC-Q101 qualified  
Base P/NHM3\_X - halogen-free, RoHS-compliant, and AEC-Q101 qualified  
("X" denotes revision code e.g. A, B, ...)

**Terminals:** matte tin plated leads, solderable per J-STD-002 and JESD 22-B102

E3, M3, HE3, and HM3 suffix meets JESD 201 class 2 whisker test

**Polarity:** for unidirectional types the band denotes cathode end, no marking on bidirectional types

MAXIMUM RATINGS ( $T_A = 25$ °C unless otherwise noted)			
PARAMETER	SYMBOL	VALUE	UNIT
Peak pulse power dissipation with a 10/1000 $\mu$ s waveform <sup>(1)(2)</sup> (fig. 1)	$P_{PPM}$	600	W
Peak pulse current with a 10/1000 $\mu$ s waveform <sup>(1)</sup>	$I_{PPM}$	See next table	A
Power dissipation on infinite heatsink at $T_A = 50$ °C	$P_D$	5.0	W
Peak forward surge current 8.3 ms single half sine-wave unidirectional only <sup>(2)</sup>	$I_{FSM}$	100	A
Operating junction and storage temperature range	$T_J, T_{STG}$	-55 to +150	°C

### Notes

<sup>(1)</sup> Non-repetitive current pulse, per fig. 3 and derated above  $T_A = 25$  °C per fig. 2

<sup>(2)</sup> Mounted on 0.2" x 0.2" (5.0 mm x 5.0 mm) copper pads to each terminal



ELECTRICAL CHARACTERISTICS (T <sub>A</sub> = 25 °C unless otherwise noted)										
DEVICE TYPE MODIFIED "J" BEND LEAD	DEVICE MARKING CODE		BREAKDOWN VOLTAGE V <sub>BR</sub> AT I <sub>T</sub> (1) (V)		TEST CURRENT I <sub>T</sub> (mA)	STAND-OFF VOLTAGE V <sub>WM</sub> (V)	MAXIMUM REVERSE LEAKAGE AT V <sub>WM</sub> I <sub>D</sub> (μA) (3)	MAXIMUM PEAK PULSE SURGE CURRENT I <sub>PPM</sub> (A) (2)	MAXIMUM CLAMPING VOLTAGE AT I <sub>PPM</sub> V <sub>C</sub> (V)	MAXIMUM TEMPERATURE COEFFICIENT OF V <sub>BR</sub> (%/°C)
	UNI	BI	MIN.	MAX.						
(+)SMBJ5.0A (5)	KE	KE	6.40	7.07	10	5.0	800	65.2	9.2	0.057
(+)SMBJ6.0A	KG	KG	6.67	7.37	10	6.0	800	58.3	10.3	0.059
(+)SMBJ6.5A	KK	AK	7.22	7.98	10	6.5	500	53.6	11.2	0.061
(+)SMBJ7.0A	KM	KM	7.78	8.60	10	7.0	200	50.0	12.0	0.065
(+)SMBJ7.5A	KP	AP	8.33	9.21	1.0	7.5	100	46.5	12.9	0.067
(+)SMBJ8.0A	KR	AR	8.89	9.83	1.0	8.0	50	44.1	13.6	0.069
(+)SMBJ8.5A	KT	AT	9.44	10.4	1.0	8.5	20	41.7	14.4	0.073
(+)SMBJ9.0A	KV	AV	10.0	11.1	1.0	9.0	10	39.0	15.4	0.074
(+)SMBJ10A	KX	AX	11.1	12.3	1.0	10	5.0	35.3	17.0	0.078
(+)SMBJ11A	KZ	KZ	12.2	13.5	1.0	11	5.0	33.0	18.2	0.080
(+)SMBJ12A	LE	BE	13.3	14.7	1.0	12	5.0	30.2	19.9	0.083
(+)SMBJ13A	LG	LG	14.4	15.9	1.0	13	1.0	27.9	21.5	0.084
(+)SMBJ14A	LK	BK	15.6	17.2	1.0	14	1.0	25.9	23.2	0.087
(+)SMBJ15A	LM	BM	16.7	18.5	1.0	15	1.0	24.6	24.4	0.088
(+)SMBJ16A	LP	LM	17.8	19.7	1.0	16	1.0	23.1	26.0	0.089
(+)SMBJ17A	LR	LR	18.9	20.9	1.0	17	1.0	21.7	27.6	0.090
(+)SMBJ18A	LT	BT	20.0	22.1	1.0	18	1.0	20.5	29.2	0.092
(+)SMBJ20A	LV	LV	22.2	24.5	1.0	20	1.0	18.5	32.4	0.094
(+)SMBJ22A	LX	BX	24.4	26.9	1.0	22	1.0	16.9	35.5	0.096
(+)SMBJ24A	LZ	BZ	26.7	29.5	1.0	24	1.0	15.4	38.9	0.096
(+)SMBJ26A	ME	CE	28.9	31.9	1.0	26	1.0	14.3	42.1	0.097
(+)SMBJ28A	MG	MG	31.1	34.4	1.0	28	1.0	13.2	45.4	0.098
(+)SMBJ30A	MK	CK	33.3	36.8	1.0	30	1.0	12.4	48.4	0.099
(+)SMBJ33A	MM	CM	36.7	40.6	1.0	33	1.0	11.3	53.3	0.100
(+)SMBJ36A	MP	CP	40.0	44.2	1.0	36	1.0	10.3	58.1	0.100
(+)SMBJ40A	MR	CR	44.4	49.1	1.0	40	1.0	9.3	64.5	0.101
(+)SMBJ43A	MT	CT	47.8	52.8	1.0	43	1.0	8.6	69.4	0.102
(+)SMBJ45A	MV	MV	50.0	55.3	1.0	45	1.0	8.3	72.7	0.102
(+)SMBJ48A	MX	MX	53.3	58.9	1.0	48	1.0	7.8	77.4	0.103
(+)SMBJ51A	MZ	MZ	56.7	62.7	1.0	51	1.0	7.3	82.4	0.104
(+)SMBJ54A	NE	NE	60.0	66.3	1.0	54	1.0	6.9	87.1	0.104
(+)SMBJ58A	NG	NG	64.4	71.2	1.0	58	1.0	6.4	93.6	0.104
(+)SMBJ60A	NK	NK	66.7	73.7	1.0	60	1.0	6.2	96.8	0.105
(+)SMBJ64A	NM	NM	71.1	78.6	1.0	64	1.0	5.8	103	0.105
(+)SMBJ70A	NP	NP	77.8	86.0	1.0	70	1.0	5.3	113	0.105
(+)SMBJ75A	NR	NR	83.3	92.1	1.0	75	1.0	5.0	121	0.106
(+)SMBJ78A	NT	NT	86.7	95.8	1.0	78	1.0	4.8	126	0.106
(+)SMBJ85A	NV	NV	94.4	104	1.0	85	1.0	4.4	137	0.106
(+)SMBJ90A	NX	NX	100	111	1.0	90	1.0	4.1	146	0.106
(+)SMBJ100A	NZ	NZ	111	123	1.0	100	1.0	3.7	162	0.107
(+)SMBJ110A	PE	PE	122	135	1.0	110	1.0	3.4	177	0.107
(+)SMBJ120A	PG	PG	133	147	1.0	120	1.0	3.1	193	0.108
(+)SMBJ130A	PK	PK	144	159	1.0	130	1.0	2.9	209	0.108
(+)SMBJ150A	PM	PM	167	185	1.0	150	1.0	2.5	243	0.108
(+)SMBJ160A	PP	PP	178	197	1.0	160	1.0	2.3	259	0.108
(+)SMBJ170A	PR	PR	189	209	1.0	170	1.0	2.2	275	0.108
SMBJ188A	PS	PS	209	231	1.0	188	1.0	2.0	328	0.108

Notes

- (1) Pulse test: t<sub>p</sub> ≤ 50 ms
- (2) Surge current waveform per fig. 3 and derate per fig. 2
- (3) For bidirectional types having V<sub>WM</sub> of 10 V and less, the I<sub>D</sub> limit is doubled
- (4) All terms and symbols are consistent with ANSI/IEEE C62.35
- (5) For the bidirectional SMBJ5.0CA, the maximum V<sub>BR</sub> is 7.25 V
- (6) V<sub>F</sub> = 3.5 V max. at I<sub>F</sub> = 50 A (unidirectional only)
- (+) Underwriters laboratory recognition for the classification of protectors (QVGG2) under the UL standard for safety 497B and file number E136766 for both uni-directional and bi-directional devices



<b>THERMAL CHARACTERISTICS</b> ( $T_A = 25\text{ }^\circ\text{C}$ unless otherwise noted)			
PARAMETER	SYMBOL	VALUE	UNIT
Typical thermal resistance, junction to ambient <sup>(1)</sup>	$R_{\theta JA}$	100	°C/W
Typical thermal resistance, junction to lead	$R_{\theta JL}$	20	

**Note**

<sup>(1)</sup> Mounted on minimum recommended pad layout

<b>ORDERING INFORMATION</b> (Example)				
PREFERRED P/N	UNIT WEIGHT (g)	PREFERRED PACKAGE CODE	BASE QUANTITY	DELIVERY MODE
SMBJ5.0A-E3/52	0.096	52	750	7" diameter plastic tape and reel
SMBJ5.0A-M3/52				
SMBJ5.0A-E3/5B	0.096	5B	3200	13" diameter plastic tape and reel
SMBJ5.0A-M3/5B				
SMBJ5.0AHE3_A/H <sup>(1)</sup>	0.096	H	750	7" diameter plastic tape and reel
SMBJ5.0AHM3_A/H <sup>(1)</sup>				
SMBJ5.0AHE3_A/I <sup>(1)</sup>	0.096	I	3200	13" diameter plastic tape and reel
SMBJ5.0AHM3_A/I <sup>(1)</sup>				

**Note**

<sup>(1)</sup> AEC-Q101 qualified

## RATINGS AND CHARACTERISTICS CURVES ( $T_A = 25\text{ }^\circ\text{C}$ unless otherwise noted)

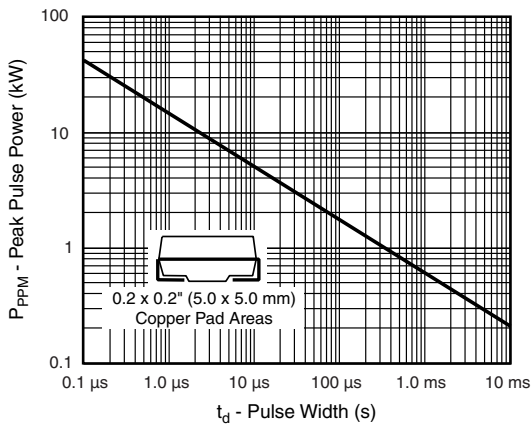

Fig. 1 - Peak Pulse Power Rating Curve

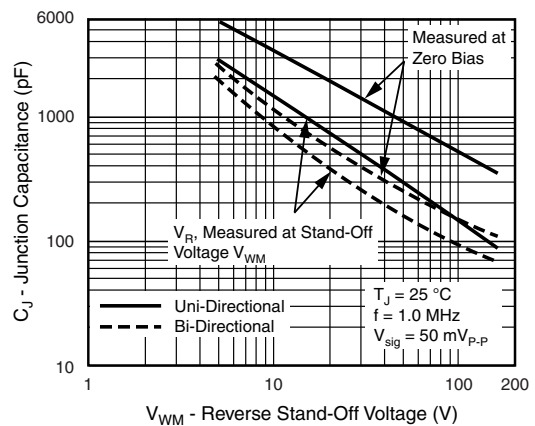

Fig. 4 - Typical Junction Capacitance

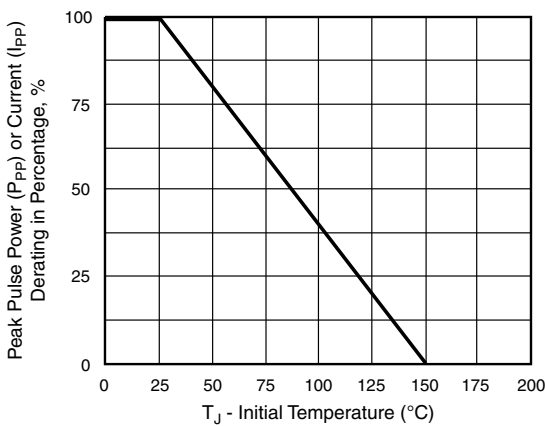

Fig. 2 - Pulse Power or Current vs. Initial Junction Temperature

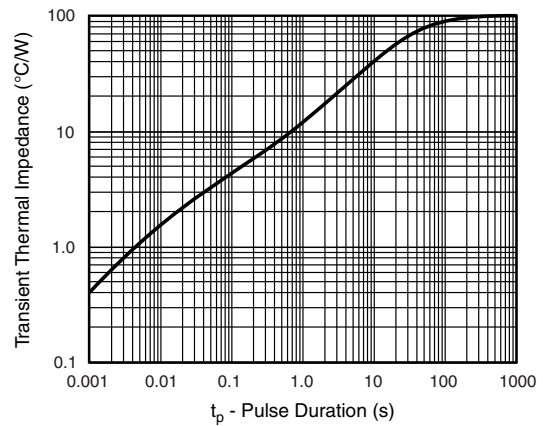

Fig. 5 - Typical Transient Thermal Impedance

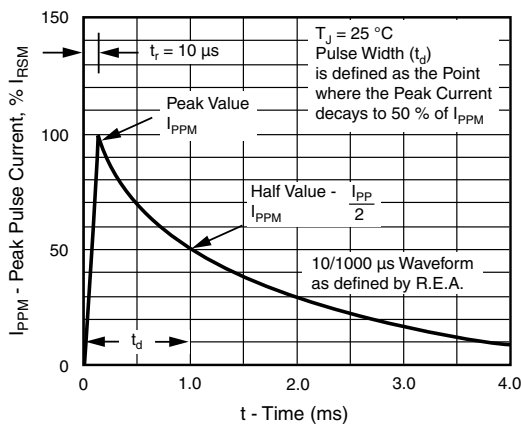

Fig. 3 - Pulse Waveform

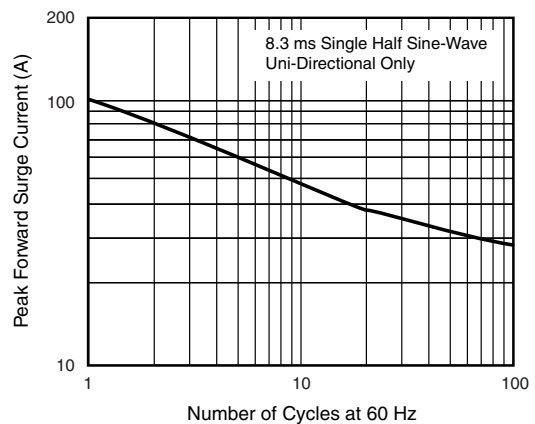
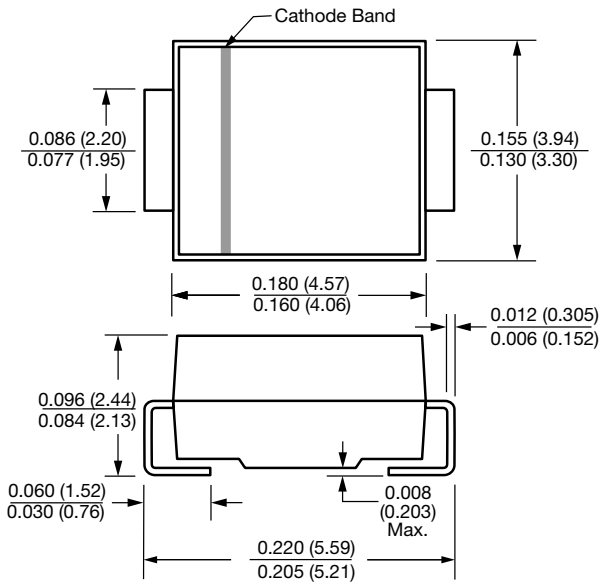

Fig. 6 - Maximum Non-Repetitive Peak Forward Surge Current



### PACKAGE OUTLINE DIMENSIONS in inches (millimeters)

SMB (DO-214AA)



Mounting Pad Layout

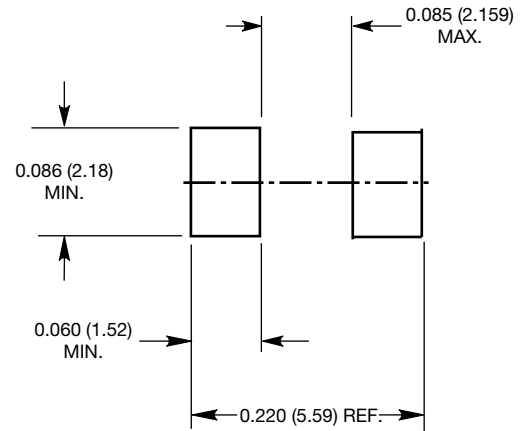



## Disclaimer

ALL PRODUCT, PRODUCT SPECIFICATIONS AND DATA ARE SUBJECT TO CHANGE WITHOUT NOTICE TO IMPROVE RELIABILITY, FUNCTION OR DESIGN OR OTHERWISE.

Vishay Intertechnology, Inc., its affiliates, agents, and employees, and all persons acting on its or their behalf (collectively, "Vishay"), disclaim any and all liability for any errors, inaccuracies or incompleteness contained in any datasheet or in any other disclosure relating to any product.

Vishay makes no warranty, representation or guarantee regarding the suitability of the products for any particular purpose or the continuing production of any product. To the maximum extent permitted by applicable law, Vishay disclaims (i) any and all liability arising out of the application or use of any product, (ii) any and all liability, including without limitation special, consequential or incidental damages, and (iii) any and all implied warranties, including warranties of fitness for particular purpose, non-infringement and merchantability.

Statements regarding the suitability of products for certain types of applications are based on Vishay's knowledge of typical requirements that are often placed on Vishay products in generic applications. Such statements are not binding statements about the suitability of products for a particular application. It is the customer's responsibility to validate that a particular product with the properties described in the product specification is suitable for use in a particular application. Parameters provided in datasheets and / or specifications may vary in different applications and performance may vary over time. All operating parameters, including typical parameters, must be validated for each customer application by the customer's technical experts. Product specifications do not expand or otherwise modify Vishay's terms and conditions of purchase, including but not limited to the warranty expressed therein.

Except as expressly indicated in writing, Vishay products are not designed for use in medical, life-saving, or life-sustaining applications or for any other application in which the failure of the Vishay product could result in personal injury or death. Customers using or selling Vishay products not expressly indicated for use in such applications do so at their own risk. Please contact authorized Vishay personnel to obtain written terms and conditions regarding products designed for such applications.

No license, express or implied, by estoppel or otherwise, to any intellectual property rights is granted by this document or by any conduct of Vishay. Product names and markings noted herein may be trademarks of their respective owners.