

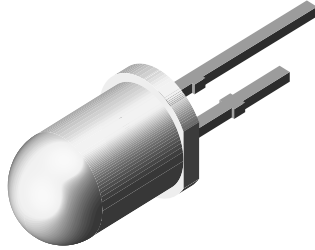

Infrared Emitting Diode, 875 nm, GaAlAs



94 8390

FEATURES

- Package type: leaded
- Package form: T-1 $\frac{3}{4}$
- Dimensions (in mm): \varnothing 5
- Leads with stand-off
- Peak wavelength: $\lambda_p = 875$ nm
- High reliability
- Angle of half intensity: $\varphi = \pm 12^\circ$
- Low forward voltage
- Suitable for high pulse current operation
- Compliant to RoHS Directive 2002/95/EC and in accordance to WEEE 2002/96/EC



DESCRIPTION

The TSHA520. series are infrared, 875 nm emitting diodes in GaAlAs technology, molded in a clear, untinted plastic package.

Note

** Please see document "Vishay Material Category Policy": www.vishay.com/doc?99902

APPLICATIONS

- Infrared remote control and free air data transmission systems
- This emitter series is dedicated to systems with panes in transmission space between emitter and detector, because of the low absorption of 875 nm radiation in glass

PRODUCT SUMMARY				
COMPONENT	I _e (mW/sr)	φ (deg)	λ_p (nm)	t _r (ns)
TSHA5200	40	± 12	875	600
TSHA5201	50	± 12	875	600
TSHA5202	60	± 12	875	600
TSHA5203	65	± 12	875	600

Note

- Test conditions see table "Basic Characteristics"

ORDERING INFORMATION			
ORDERING CODE	PACKAGING	REMARKS	PACKAGE FORM
TSHA5200	Bulk	MOQ: 4000 pcs, 4000 pcs/bulk	T-1 $\frac{3}{4}$
TSHA5201	Bulk	MOQ: 4000 pcs, 4000 pcs/bulk	T-1 $\frac{3}{4}$
TSHA5202	Bulk	MOQ: 4000 pcs, 4000 pcs/bulk	T-1 $\frac{3}{4}$
TSHA5203	Bulk	MOQ: 4000 pcs, 4000 pcs/bulk	T-1 $\frac{3}{4}$

Note

- MOQ: minimum order quantity



ABSOLUTE MAXIMUM RATINGS (T _{amb} = 25 °C, unless otherwise specified)				
PARAMETER	TEST CONDITION	SYMBOL	VALUE	UNIT
Reverse voltage		V _R	5	V
Forward current		I _F	100	mA
Peak forward current	t _p /T = 0.5, t _p = 100 μs	I _{FM}	200	mA
Surge forward current	t _p = 100 μs	I _{FSM}	2.5	A
Power dissipation		P _V	180	mW
Junction temperature		T _j	100	°C
Operating temperature range		T _{amb}	- 40 to + 85	°C
Storage temperature range		T _{stg}	- 40 to + 100	°C
Soldering temperature	t ≤ 5 s, 2 mm from case	T _{sd}	260	°C
Thermal resistance junction/ambient	J-STD-051, leads 7 mm, soldered on PCB	R _{thJA}	230	K/W

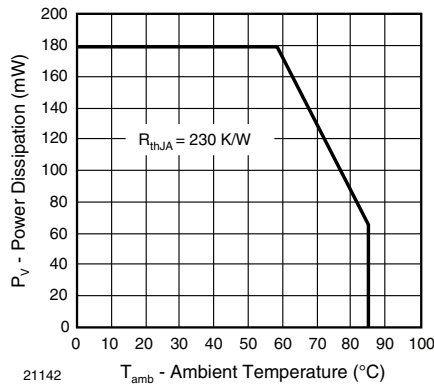

Fig. 1 - Power Dissipation Limit vs. Ambient Temperature

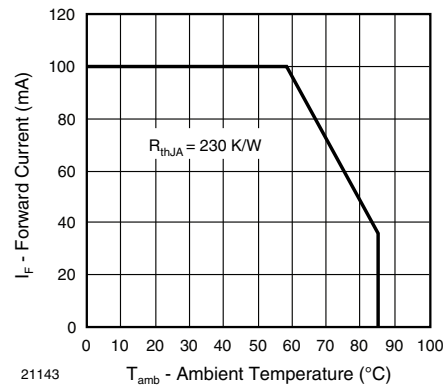

Fig. 2 - Forward Current Limit vs. Ambient Temperature

BASIC CHARACTERISTICS (T _{amb} = 25 °C, unless otherwise specified)						
PARAMETER	TEST CONDITION	SYMBOL	MIN.	TYP.	MAX.	UNIT
Forward voltage	I _F = 100 mA, t _p = 20 ms	V _F		1.5	1.8	V
Temperature coefficient of V _F	I _F = 100 mA	TK _{V_F}		- 1.6		mV/K
Reverse current	V _R = 5 V	I _R			100	μA
Junction capacitance	V _R = 0 V, f = 1 MHz, E = 0	C _j		20		pF
Temperature coefficient of φ _e	I _F = 20 mA	TKφ _e		- 0.7		%/K
Angle of half intensity		φ		± 12		deg
Peak wavelength	I _F = 100 mA	λ _p		875		nm
Spectral bandwidth	I _F = 100 mA	Δλ		80		nm
Temperature coefficient of λ _p	I _F = 100 mA	TKλ _p		0.2		nm/K
Rise time	I _F = 100 mA	t _r		600		ns
	I _F = 1 A	t _r		300		ns
Fall time	I _F = 100 mA	t _f		600		ns
	I _F = 1 A	t _f		300		ns
Virtual source diameter		d		3.7		mm



TYPE DEDICATED CHARACTERISTICS ($T_{amb} = 25\text{ }^{\circ}\text{C}$, unless otherwise specified)							
PARAMETER	TEST CONDITION	PART	SYMBOL	MIN.	TYP.	MAX.	UNIT
Forward voltage	$I_F = 1\text{ A}$, $t_p = 100\text{ }\mu\text{s}$	TSHA5200	V_F		2.8	3.5	V
		TSHA5201	V_F		2.8	3.5	V
		TSHA5202	V_F		2.8	3.5	V
		TSHA5203	V_F		2.8	3.5	V
Radiant intensity	$I_F = 100\text{ mA}$, $t_p = 20\text{ }\mu\text{s}$	TSHA5200	I_e	25	40	125	mW/sr
		TSHA5201	I_e	30	50	125	mW/sr
		TSHA5202	I_e	36	60	125	mW/sr
		TSHA5203	I_e	50	65	125	mW/sr
	$I_F = 1\text{ A}$, $t_p = 100\text{ }\mu\text{s}$	TSHA5200	I_e	200	330		mW/sr
		TSHA5201	I_e	260	400		mW/sr
		TSHA5202	I_e	330	460		mW/sr
		TSHA5203	I_e	400	530		mW/sr
Radiant power	$I_F = 100\text{ mA}$, $t_p = 20\text{ }\mu\text{s}$	TSHA5200	ϕ_e		22		mW
		TSHA5201	ϕ_e		23		mW
		TSHA5202	ϕ_e		24		mW
		TSHA5203	ϕ_e		25		mW

BASIC CHARACTERISTICS ($T_{amb} = 25\text{ }^{\circ}\text{C}$, unless otherwise specified)

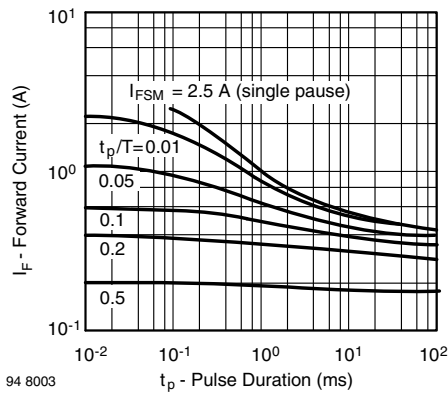

Fig. 3 - Pulse Forward Current vs. Pulse Duration

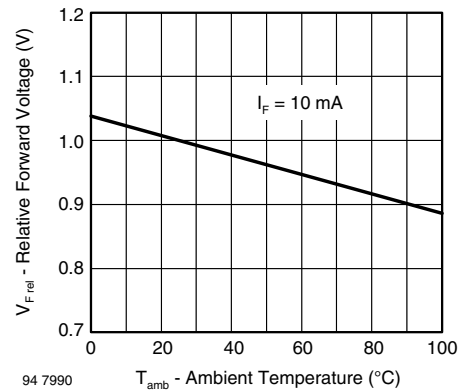

Fig. 5 - Relative Forward Voltage vs. Ambient Temperature

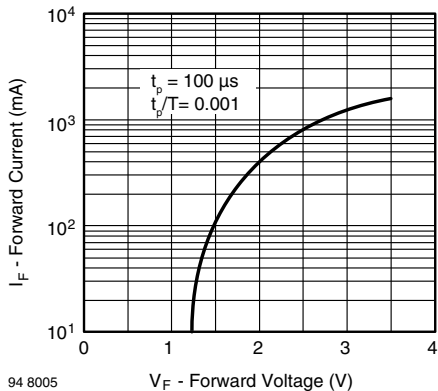

Fig. 4 - Forward Current vs. Forward Voltage

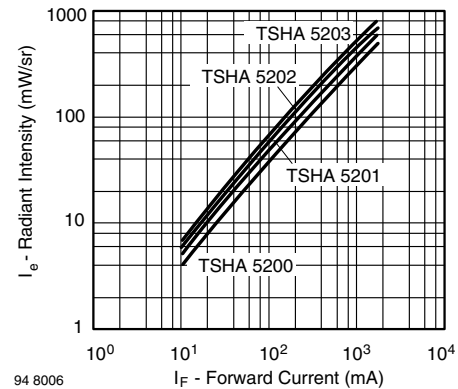

Fig. 6 - Radiant Intensity vs. Forward Current

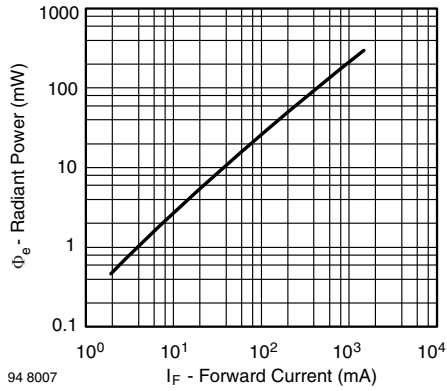

Fig. 7 - Radiant Power vs. Forward Current

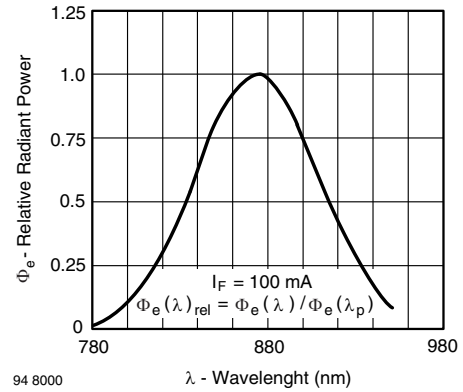

Fig. 9 - Relative Radiant Power vs. Wavelength

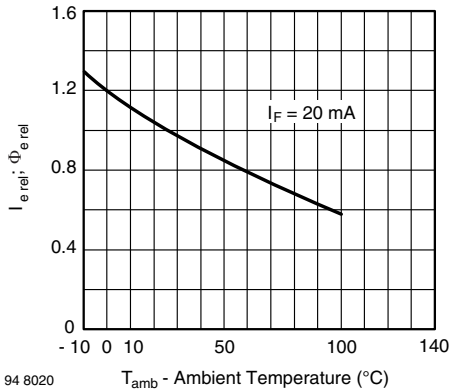

Fig. 8 - Relative Radiant Intensity/Power vs. Ambient Temperature

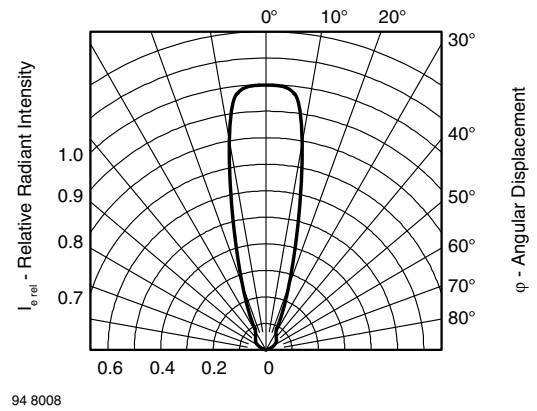
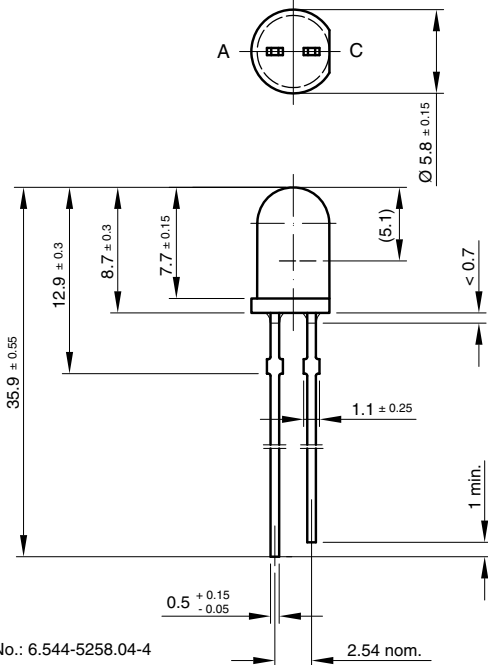
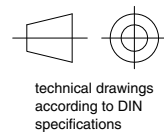
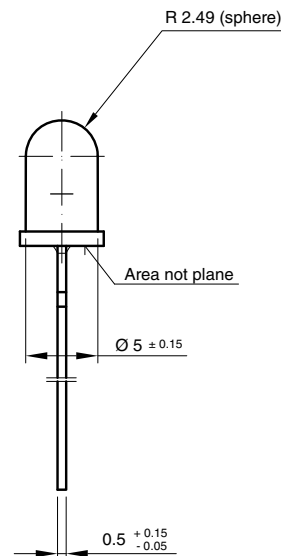

Fig. 10 - Relative Radiant Intensity vs. Angular Displacement

PACKAGE DIMENSIONS in millimeters



Drawing-No.: 6.544-5258.04-4
Issue: 9; 23.07.10
96 12121





Disclaimer

ALL PRODUCT, PRODUCT SPECIFICATIONS AND DATA ARE SUBJECT TO CHANGE WITHOUT NOTICE TO IMPROVE RELIABILITY, FUNCTION OR DESIGN OR OTHERWISE.

Vishay Intertechnology, Inc., its affiliates, agents, and employees, and all persons acting on its or their behalf (collectively, "Vishay"), disclaim any and all liability for any errors, inaccuracies or incompleteness contained in any datasheet or in any other disclosure relating to any product.

Vishay makes no warranty, representation or guarantee regarding the suitability of the products for any particular purpose or the continuing production of any product. To the maximum extent permitted by applicable law, Vishay disclaims (i) any and all liability arising out of the application or use of any product, (ii) any and all liability, including without limitation special, consequential or incidental damages, and (iii) any and all implied warranties, including warranties of fitness for particular purpose, non-infringement and merchantability.

Statements regarding the suitability of products for certain types of applications are based on Vishay's knowledge of typical requirements that are often placed on Vishay products in generic applications. Such statements are not binding statements about the suitability of products for a particular application. It is the customer's responsibility to validate that a particular product with the properties described in the product specification is suitable for use in a particular application. Parameters provided in datasheets and/or specifications may vary in different applications and performance may vary over time. All operating parameters, including typical parameters, must be validated for each customer application by the customer's technical experts. Product specifications do not expand or otherwise modify Vishay's terms and conditions of purchase, including but not limited to the warranty expressed therein.

Except as expressly indicated in writing, Vishay products are not designed for use in medical, life-saving, or life-sustaining applications or for any other application in which the failure of the Vishay product could result in personal injury or death. Customers using or selling Vishay products not expressly indicated for use in such applications do so at their own risk. Please contact authorized Vishay personnel to obtain written terms and conditions regarding products designed for such applications.

No license, express or implied, by estoppel or otherwise, to any intellectual property rights is granted by this document or by any conduct of Vishay. Product names and markings noted herein may be trademarks of their respective owners.

Material Category Policy

Vishay Intertechnology, Inc. hereby certifies that all its products that are identified as RoHS-Compliant fulfill the definitions and restrictions defined under Directive 2011/65/EU of The European Parliament and of the Council of June 8, 2011 on the restriction of the use of certain hazardous substances in electrical and electronic equipment (EEE) - recast, unless otherwise specified as non-compliant.

Please note that some Vishay documentation may still make reference to RoHS Directive 2002/95/EC. We confirm that all the products identified as being compliant to Directive 2002/95/EC conform to Directive 2011/65/EU.

Vishay Intertechnology, Inc. hereby certifies that all its products that are identified as Halogen-Free follow Halogen-Free requirements as per JEDEC JS709A standards. Please note that some Vishay documentation may still make reference to the IEC 61249-2-21 definition. We confirm that all the products identified as being compliant to IEC 61249-2-21 conform to JEDEC JS709A standards.