



## Glass Passivated Three Phase Rectifier Bridge

**VRRM** 800 to 1800V  
**ID** 75 Amp

### Applications

- Three phase rectifiers for power supplies
- Rectifiers for DC motor field supplies
- Battery charger rectifiers
- Input rectifiers for variable frequency drives

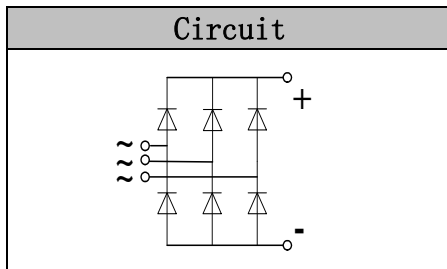

### Features

- Three phase bridge rectifier
- Blocking voltage: 800 to 1800V
- Heat transfer through aluminum oxide DBC ceramic isolated metal baseplate
- Glass passivated chip

### Module Type

TYPE	VRRM	VRSM
MD75S08M2	800V	900V
MD75S12M2	1200V	1300V
MD75S16M2	1600V	1700V
MD75S18M2	1800V	1900V

### Maximum Ratings

Symbol	Conditions	Values	Units
ID	Three phase, full wave Tc=110°C	75	A
IFSM	t=10mS Tvj =45°C	750	A
i <sup>2</sup> t	t=10mS Tvj =45°C	2800	A <sup>2</sup> s
Visol	a.c.50HZ;r.m.s.;1min	3000	V
Tvj		-40 to +150	°C
Tstg		-40 to +125	°C
Mt	To terminals(M5)	5±15%	Nm
Ms	To heatsink(M5)	5±15%	Nm
Weight	Module (Approximately)	130	g

### Thermal Characteristics

Symbol	Conditions	Values	Units
Rth(j-c)	Per diode	1.1	°C/W
Rth(c-s)	Module (Approximately)	0.07	°C/W

### Electrical Characteristics

Symbol	Conditions	Values			Units
		Min.	Typ.	Max.	
VFM	T=25°C IF =150A	—	1.38	1.60	V
IRD	Tvj=25°C VRD=VRRM	—	—	0.3	mA
	Tvj=150°C VRD=VRRM	—	—	5	mA

## Performance Curves

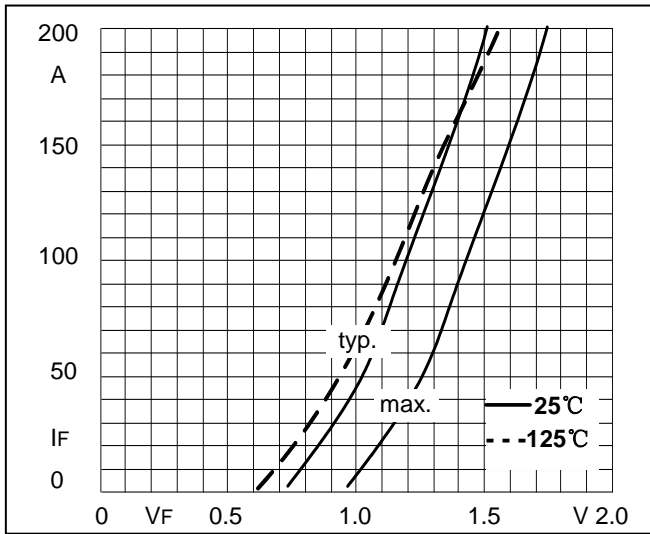

**Fig1. Forward Characteristics**

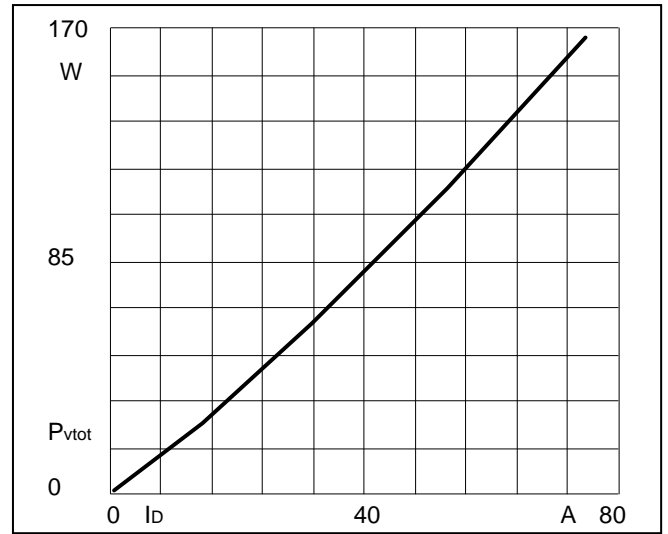

**Fig2. Power dissipation**

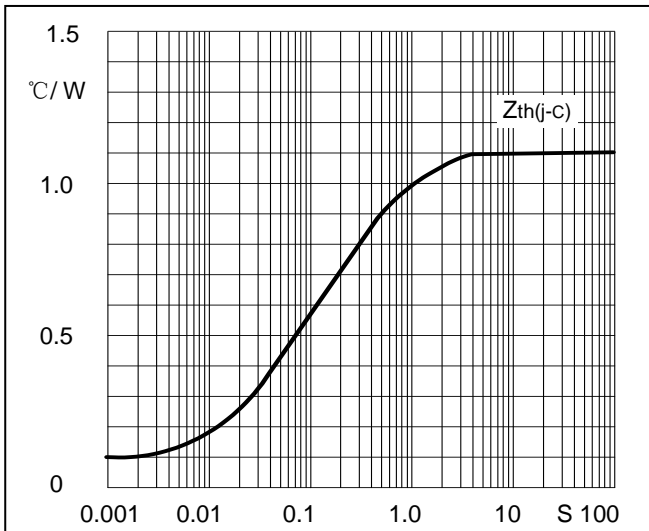

**Fig3. Transient thermal impedance**

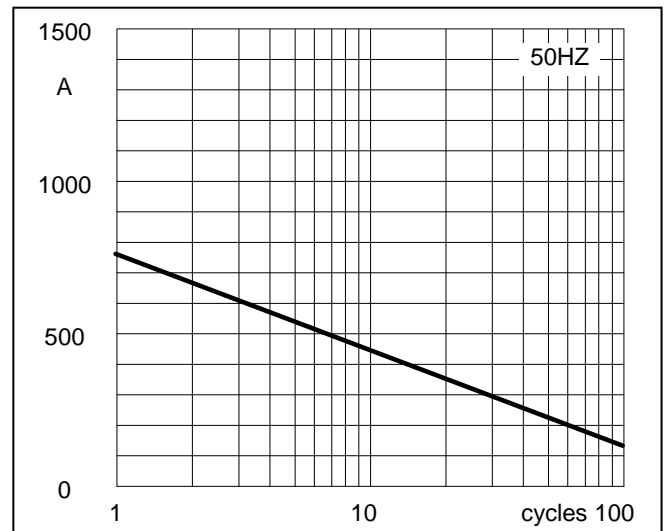

**Fig4. Max Non-Repetitive Forward Surge Current**

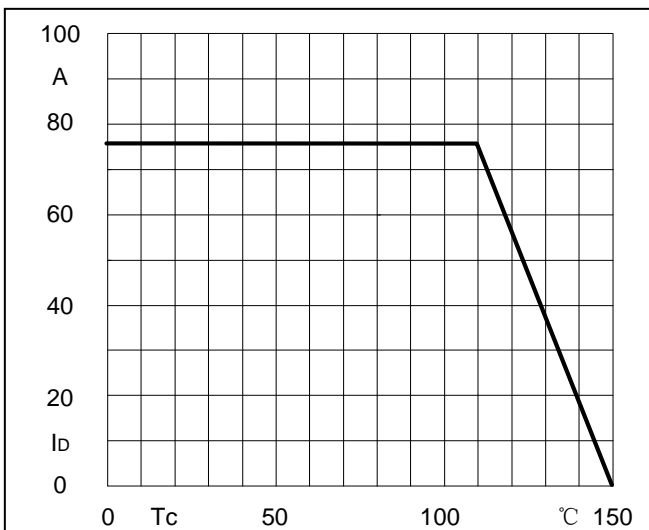

**Fig5. Forward Current Derating Curve**

## Package Outline Information

CASE: M2

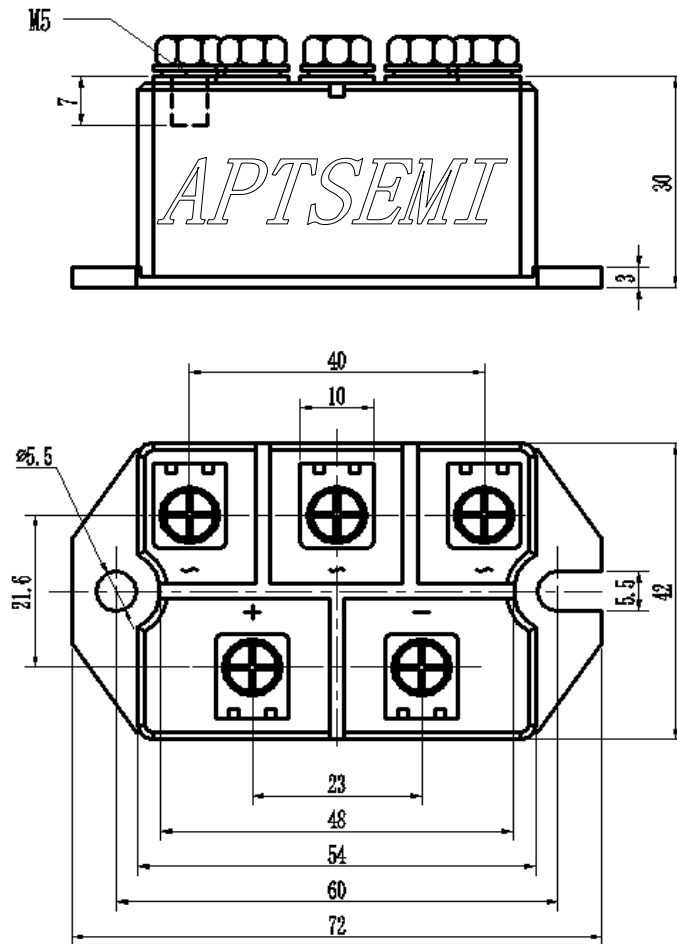

Dimensions in mm